

Lux-May

Catálogo
Tarifa
2013
ESP

5
u
i
t
u
5
i
i

OFICINA CENTRAL

LUX-MAY, Manufacturas Plásticas May, S.A.

Euba s/n, 48340

Amorebieta (Vizcaya) - España

Tel.: + 34 946 308 180*

Fax: +34 946 734 143

e-mail: lighting@lux-may.com

www.lux-may.com

LUX-MAY, Manufacturas Plásticas May, S.A.

La granja 11, Pol. Ind. - 28108

Alcobendas (Madrid) - España

Tel.: +34 916 620 071*

Fax: +34 916 611 219

Guilting

Lux-May











Catálogo
Tarifa

2013

ESP

*esta tarifa entrará en vigor a partir del 1 de enero de 2013

SUSPENDIDAS  T-5 T-8	1
SUSPENDIDAS LINEAS CONTINUAS	10
SUSPENDIDAS SERIE CARRIL LINE STYLE HALOGENOS DESCARGA	14
MULTIDIRECCIONALES ADOSABLES / SUSPENDIDOS SERIE COMPACT	16
MULTIDIRECCIONALES CON LAMPARAS  PHILIPS HALOGENOS DESCARGA	17
DOWNLIGHTS EMPOTRABLES  LAMPARAS COMPACTAS DOWNLIGHTS MAXI	22
DOWNLIGHTS EMPOTRABLES DESCARGA	29
DOWNLIGHTS CUADRADOS EMPOTRABLES	31
DOWNLIGHTS ADOSABLES  / SUSPENDIDOS 	35
DOWNLIGHTS ADOSABLES / SUSPENDIDOS	36
EMPOTRABLES SECCION REDUCIDA T-5 LINEAS CONTINUAS	39
EMPOTRABLES SECCION REDUCIDA T-5	39
EMPOTRABLES DECORATIVOS  EMPOTRABLES DECORATIVOS ILUMINACION INDIRECTA 	40
EMPOTRABLES CON TUBOS  PHILIPS	41
EMPOTRABLES T-5 BAJA LUMINANCIA	42
EMPOTRABLES T-8 BAJA LUMINANCIA	46
EMPOTRABLES ULTIMA GENERACION T5-FC	49
EMPOTRABLES IP54 / IP65 SALAS BLANCAS	50
EMPOTRABLES POLIVALENTES LAMPARAS COMPACTAS	52
EMPOTRABLES T-5 ILUMINACION INDIRECTA DIRECTA /ASIMETRICA	53
EMPOTRABLES ILUMINACION INDIRECTA  T-5 TC-L	54
ADOSABLES ILUMINACION INDIRECTA	56
ADOSABLES Y EMPOTRABLES PARA LAMPARAS TC-L Y TC-D	57
ADOSABLES 	58
ADOSABLES T-5 BAJA LUMINANCIA	58
ADOSABLES O SUSPENDIDAS T5 AREAS INDUSTRIALES	59
ADOSABLES IP54 SALAS BLANCAS	60

ADOSABLES T-8	61
ADOSABLES T-5	62
ADOSABLES ULTIMA GENERACION T5-FC	64
ASIMETRICAS ADOSABLES / EMPOTRABLES BALADORES DE PARED	65
ADOSABLES CIRCULARES  T5-FC / SUSPENDIDOS CIRCULARES  T5-FC	66
APLIQUES ADOSABLES 	67
ADOSABLES CIRCULARES OJOS DE BUEY	67
LUMINARIAS DE EMERGENCIA	68
ALUMBRADO PUBLICO Y RESIDENCIAL  DESCARGA FLUORESCENCIA	69
ESFERICAS DESCARGA	73
PROYECTOR ATHENA /ARCOS 1000W - 2000W DESCARGA	75
PROYECTORES DESCARGA PROYECTORES 	78
PROYECTORES DESCARGA / T-5 SERIE RESIDENCIAL	81
APLIQUES ADOSABLES / PARED DESCARGA SERIE RESIDENCIAL	83
PROYECTORES HALOGENOS DESCARGA LAMPARAS COMPACTAS	84
BALIZAS EMPOTRABLES DE SUELO SERIE RESIDENCIAL	86
BALIZAS SERIE RESIDENCIAL	87
CAMPANAS DECORATIVAS  DESCARGA LAMPARAS COMPACTAS	88
LUMINARIAS INDUSTRIALES  CAMPANAS INDUSTRIALES Y DECORATIVAS	90
ESTANCAS IP65 CON TUBOS  PHILIPS T-8 T-5	94
ESTANCAS BAJAS TEMPERATURAS TUNELES	96
REGLETAS INDUSTRIALES	96
REGLETAS ESTANCAS IP65	97
REGLETAS CON TUBOS  PHILIPS	97
REGLETAS MINI  / FLUORESCENCIA	98
REGLETAS REFLECTORES ACCESORIOS	99
KITS DE EMERGENCIA MONTADOS EN LUMINARIAS	100

SUSPENDIDAS

NAVKA 1 	DIMA 1 	T5-OS-LED 1 	T5-OS/GRIS-LED 1 	SIAM-LED 1 	LEDBOX/L 2 
LEDBOX-MAX/SUS 2 	LEDBOX-C/SUS 2 				



SUSPENDIDAS

LIMIT 3 	EXTREME/MICROPRISMA 3 	T5-GL 3 	T5-R 4 	T5-SBTN 4 	T5-L 5 
T5-L 5 	T5-L/MICROPRISMA 5 	EVOLUTION 5 	EVOLUTION/GRIS 5 	T5-X 6 	T5-X/GRIS 6 
T5-OS 6 	T5-OS/GL 7 	T5-OS/GLS 7 	T8-S 7 	AVATAR 8 	AVATAR/LV 8 
AVATAR/PRISMA 8 	FUTUR/BR 9 	FUTUR/MR 9 	FUTUR/OPAL 9 	FUTUR/SYM 9 	FUTUR/ASYM 9 



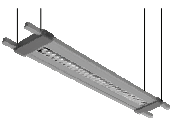
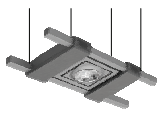
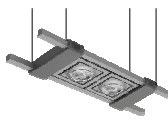
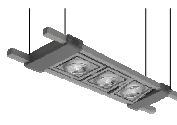

SUSPENDIDAS LINEAS CONTINUAS

FUTUR/BR/LINEA 10 	FUTUR/MR/LINEA 10 	FUTUR/OPAL/LINEA 11 	FUTUR/SYM/LINEA 11 	FUTUR/ASYM/LINEA 11 	T5-L/LINEA 12 
T5-L/MICROPRISMA/LINEA 12 	EVOLUTION/LINEA 13 				

SUSPENDIDAS SERIE CARRIL LINE STYLE

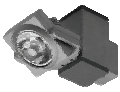
LINE STYLE/T5-X/GRIS 14	LINE STYLE-1x 14	LINE STYLE-2x 14	LINE STYLE-3x 14	ACCESORIOS LINE STYLE 15	STILE/C 15
					

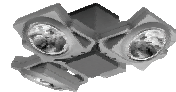
MULTIDIRECCIONALES ADOSABLES / SUSPENDIDOS SERIE COMPACT

COMPACT-1 16	COMPACT-2 16	COMPACT-3 16	COMPACT/SUS-2 16	COMPACT/SUS-4 16	
					

MULTIDIRECCIONALES CON LAMPARAS

LXR-111-LED 17	RS-111-LED 17	RSMR-LED 17	LXR-111-LED-HQI 17	LXR-111-LED-1RD 18	EXT-111-LED 18
					
LXS-111-LED-8 18	LX-111-LED-10 18				
					
RSH-ORO-LED 18	LXR-PAR30S-LED 18	EXT-PAR30S-LED 18	LXBL-111-LED 18	LXBC-111-LED 18	LXS-111-LED-2 18
					











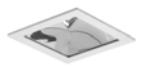

MULTIDIRECCIONALES

LX-111-10 19	LXBL-111 19	LXBC-111 19	LXS-111-2 19	LXS-111-4 19	LXS-111-8 19
					
LXR-111-3-HQI 19	LXR-111-1RD 19	LXR-111 19	LXR-PAR30S 20	LXL-PAR30L 20	EXT-PAR30S 20
					

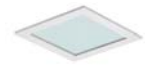
DOWNLIGHTS EMPOTRABLES DESCARGA

DLUX-IP44-G12 	29	CRT-RX7s 	30	DTM-IP44-RX7s/G12 	30	RXH-G12 	30	RXH-RX7s 	30
--	----	---	----	--	----	--	----	---	----

DOWNLIGHTS CUADRADOS EMPOTRABLES • LAMPARAS COMPACTAS

HERA-225 	22	DSQ-230 LED 	23	DECO/BL 	31	DECO/NE 	31	DECO/GR 	31	LUXUS-243/A 	32
LUXUS-269/A 	32	LUXUS-243/BR 	32	LUXUS-269/BR 	32	LUXUS-243/OPAL 	32	LUXUS-269/OPAL 	32	LUXUS/GRIS-243/A 	33
LUXUS/GRIS-269/A 	33	LUXUS/GRIS-243/BR 	33	LUXUS/GRIS-269/BR 	33	LUXUS/GRIS-243/OPAL 	33	LUXUS/GRIS-269/OPAL 	33		

DOWNLIGHTS ADOSABLES / SUPENDIDOS

KER LED 	35	KERSUS LED 	35	KERPAR LED 	35	CILINDER/LED 	35		
--	----	---	----	---	----	---	----	--	--



DOWNLIGHTS ADOSABLES / SUSPENDIDOS

CILINDER/B 	36	CILINDER/C 	36	TURBO CILINDER/B 	36	TURBO CILINDER/C 	36	CILINDER/OPAL-IP40 	36	CILINDER/DGA 	37
DEB/S 	37	DEN/S 	37	DENE/S 	37	DEGR/S 	37	DEOS/S 	37	DEOB/S 	37



DOWNLIGHTS ADOSABLES / SUSPENDIDOS

DECB/S 37	PERLA/G12 37	GEMA/IP40 38	GEMA/OPAL/IP40 38	GEMA 38	GEMA-OVALY 38
					
GEMA-OVALY/GRIS 38					
					





EMPOTRABLES SECCION REDUCIDA T-5 ● LINEAS CONTINUAS

T5-PTE/BR/LINEA 39	T5-PTE/MR/LINEA 39	T5-PTE/OPAL/LINEA 39			
					

EMPOTRABLES SECCION REDUCIDA T-5

T5-PTE/BR 39	T5-PTE/MR 39	T5-PTE/OPAL 39			
					

EMPOTRABLES

ARIAN 40	IRIS 40	ALOS 40	T55/UL LED 41	T55/MICROPRISMA LED 41	T5-PTE/OPAL LED 41
					
					
PTE/OPALPC-IP65 LED 41					
					
					

EMPOTRABLES CON TUBOS PHILIPS

P/EXTL LED 41	POL/OPAL LED 41				
					
					

EMPOTRABLES T-5

T5NKB 42	T5NK 42	T5N 42	T5N/C 42	T5-A 42	T5N/MICRO 42
T5-A/MICRO 42	T5N-PTE 43	T5N/MICRO-PTE 43	T5/BR 43	T5-PTE/BR 43	T5/MR 43
T5-PTE/MR 43	T5/PRISMA 44	T5/OPAL 44	T55/UM 44	T55/UMM 44	T5/UMBR 44
T55/UMMR 44	T55/ULBR 45	T55/ULMR 45	T55/UL 45	T55/ULM 45	T55/PRISMA 45
T55/UB 45					









EMPOTRABLES T-8

P/EXTL 46	P/EXT 46	PTE/EXT 46	P/LV 46	PTE/LV 46	P/BRL 47
P/BR 47	PTE/BR 47	P/MR 47	PTE/MR 47	P/PRISMA 48	PTE/PRISMA 48
P/OPAL 48	PTE/OPAL 48				



EMPOTRABLES ULTIMA GENERACION T5-FC

PYRAMIDE/E-OPAL-IN 49	PYRAMIDE/E-OPAL-OUT 49	PYRAMIDE/E-PRISMA-IN 49	PYRAMIDE/E-PRISMA-OUT 49		
					



EMPOTRABLES IP54 / IP65 SALAS BLANCAS • ESCAYOLA • MODULARES

PTE/BRPC-IP54 P/BRPC-IP54 50	PTE/MRPC-IP54 P/MRPC-IP54 50	PTE/OPALPC-IP54 P/OPALPC-IP54 50	PTE/PRISMAPC-IP54 P/PRISMAPC-IP54 50	PTE/BRPC-IP65 P/BRPC-IP65 51	PTE/MRPC-IP65 P/MRPC-IP65 51
					
PTE/OPALPC-IP65 P/OPALPC-IP65 51	PTE/PRISMAPC-IP65 P/PRISMAPC-IP65 51				
					



EMPOTRABLES IP54 SALAS BLANCAS TECHOS MODULARES 600x600

LSBR/E-IP54 52	LOPAL/E-IP54 52	LPRISMA/E-IP54 52			
					

EMPOTRABLES POLIVALENTES LAMPARAS COMPACTAS

PCM/EXT 52	PCM/BR 52	PCM/MR 52			
					

EMPOTRABLES T-5 ILUMINACION INDIRECTA • DIRECTA /ASIMETRICA

T5-INDIR 53	T5-DIR/ASYM 3x 53	T5-DIR/ASYM 4x 53			
					

EMPOTRABLES ILUMINACION INDIRECTA

LD-LED/C 54	LD/C 54	LD 54	LDL 54	LDA 54	LDX 54
LD/BR 54	LD/BR-T5/C 55	LD/BR-T5 55	LD/BRD/C 55	LD/BRD 55	LD-ELITE 55
LD/GM 55					

ADOSABLES ILUMINACION INDIRECTA

LD/S-2x 56	LD/S-1x 56	LDX/S 56	LD/BR/S 56	LD/BR-T5/S 56	LD/BRD/S 56
------------	------------	----------	------------	---------------	-------------

ADOSABLES Y EMPOTRABLES PARA LAMPARAS TC-L Y TC-D

NPL/BR 57	NPL/MR 57	EPL/BR 57	EPL/MR 57	EPL/CRISTAL 57	INDI 57
-----------	-----------	-----------	-----------	----------------	---------

ADOSABLES

LEDBOX/C 58					
-------------	--	--	--	--	--



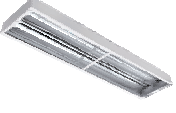
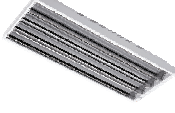
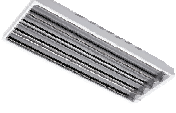

ADOSABLES T-5 BAJA LUMINANCIA

NV-4x 58	NV-2x 58	NT-5-4x 58	NT-5-2x 58	NX-T5 59	ALUX 59
----------	----------	------------	------------	----------	---------



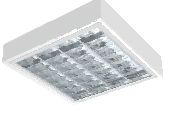





ADOSABLES O SUSPENDIDAS T5 AREAS INDUSTRIALES

POWER-REFLEX/COMPACT 59	POWER-REFLEX 59	POWER-ULTRAREFLEX 59			
					







ADOSABLES IP54 SALAS BLANCAS

N/BRPC-IP54 60	N/MRPC-IP54 60	N/OPALPC-IP54 60	N/PRISMAPC-IP54 60		
					



ADOSABLES T-8

MN/EXTL 61	N/EXT 61	N/LV 61	N/PRISMA 61	N/OPAL 61	MN/BRL 62
					
N/BR 62	N/MR 62	MN/T8/EXT 62	KTX/N 63	EU-2x18 63	
					





ADOSABLES T-5

MN/T5/EXT 62	IMPACT 63	OPTIMA/OPAL 63	OPTIMA/PRISMA 63	NOVA/OPAL 63	NOVA/PRISMA 63
					
	AREAS DEPORTIVAS				

ADOSABLES ULTIMA GENERACION T5-FC

PYRAMIDE/S-OPAL-IN 64	PYRAMIDE/S-OPAL-OUT 64	PYRAMIDE/S-PRISMA-IN 64	PYRAMIDE/S-PRISMA-OUT 64		
					





ASIMETRICAS ADOSABLES / EMPOTRABLES • BAÑADORES DE PARED

COMET 65	ASYM/S 65	ASYM-T5/S 65	ASYM/PTE 65	ASYM-T5/PTE 65	
					



ADOSABLES CIRCULARES / SUSPENDIDOS CIRCULARES

CIRCUINE LED 66	CIRCUINE LED/GRIS 66	CIRCUINE PENDULAR LED 66	CIRCUINE PENDULAR LED/GRIS 66		
					

ADOSABLES CIRCULARES T5-FC / SUSPENDIDOS CIRCULARES T5-FC

CIRCUINE 66	CIRCUINE/GRIS 66	CIRCUINE PENDULAR 66	CIRCUINE PENDULAR/GRIS 66		
					

APLIQUES ADOSABLES

LUNA LED-350 67	SC LED-300 67				
					

ADOSABLES CIRCULARES • OJOS DE BUEY

LUNA 67	A/E27/G23 67	AX/E27/G23 67	CLT-IP44 67	SLO 67	SLP 67
					



LUMINARIAS DE EMERGENCIA

E-1000 68	E-2000 68	E-3000 68	E-4000L 68	E-5000L 68	E-6000 68
					





ALUMBRADO PUBLICO Y RESIDENCIAL

OPTIMUS LED 69 	DENTHIA 69 	ZEPHYR 70 	ZAKLA 70 	LPX-LED 70 	LPX/AL-LED 70 
--	--	---	---	--	---



ALUMBRADO RESIDENCIAL DESCARGA / FLUORESCENCIA

CITY 1 71 	CITY 2 71 	VELTA 71 			
---	---	--	--	--	--

ALUMBRADO PUBLICO DESCARGA Y LAMPARAS COMPACTAS

ANDROMEDA 72 	FORNAX 72 	ALCOTAN 72 	LPX 72 		
---	---	---	---	--	--

ESFERICAS DESCARGA

LPP-I/APL/GRIS-500 73 	LPO 73 	LPI 73 	LPF 73 	LEO 74 	ELEMENTOS ESFERICAS 74 
---	--	--	--	--	--

PROYECTOR ATHENA /ARCOS 1000W - 2000W • DESCARGA

ATHENA 75 	ATHENA BOOSTER 75 	ARCOS/SIMETRICO-1000W. 76 	ARCOS/ASIMETRICO-1000W. 76 	ARCOS/CIRCULAR-1000W. 76 	ARCOS/SIMETRICO-2000W. 77 
ARCOS/ASIMETRICO-2000W. 77 	ARCOS/CIRCULAR-2000W. 77 				

PROYECTORES DESCARGA

LUX/C-1000W. 78	LUX/M-1000W. 78	LUX/M-2000W. 78	RES, REH 78	TPS, TPH 79	PRS/C, PRH/C 79
TCS, TCH 79	TELEC 80	PARK/SYM 80	PARK/SPOT 80	FC 80	FC/BDR 80
LSH 80	LSCD 80	PST/S-IP65 85	PST/GA-IP65 85		

PROYECTOR

FOCUS MAX 81	INDUS IP65 85	ALUFORCE 90	ALUFORCE/E 90		
--------------	---------------	-------------	---------------	--	--









PROYECTORES DESCARGA / T-5 • SERIE RESIDENCIAL

VILLA-160 81	VILLA-240 81	VILLA-260 81	LYRIS-REF 82	LYRIS-SYM, LYRIS-ASYM 82	
--------------	--------------	--------------	--------------	--------------------------	--

APLIQUES ADOSABLES / PARED • DESCARGA • SERIE RESIDENCIAL

NELL 83	WAKO-1 83	WAKO-2 83	WAKO-3 83		
---------	-----------	-----------	-----------	--	--





PROYECTORES HALOGENOS • DESCARGA • LAMPARAS COMPACTAS

PCR-150 84	PCR-500 84	PC-150 84	PC-500 84	PC-1000 84	PC-1500 84
					
PXM, PXS, PXH 84	PX-PLL-2x18W. 84				
					











BALIZAS EMPOTRABLES DE SUELO • DESCARGA / T-5 • SERIE RESIDENCIAL

DOE-ASYM 86	DOD-6 86	DOF 86	WOI/SYM • T-5 86		
					



BALIZAS • SERIE RESIDENCIAL

BALI-1 87	BALI-2 87	BALI-3 87	JAVA-1 87	JAVA-2 87	
					





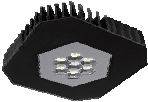
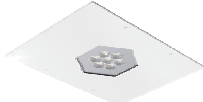







CAMPANAS DECORATIVAS

STILO L LED (BASIC 1) 88	STILO L LED (BASIC 2) 88	STILO L LED (BASIC 3) 88	STILO L LED (BASIC 4) 88	STILO L LED (EXCLUSIVE 1) 88	STILO L LED (EXCLUSIVE 2) 88
					
STILO L / XL (BASIC 1) 89	STILO L / XL (BASIC 2) 89	STILO L / XL (BASIC 3) 89	STILO L / XL (BASIC 4) 89	STILO L / XL (INDUSTRIAL 1) 89	STILO L / XL (INDUSTRIAL 2) 89
					
STILO L / XL (INDUSTRIAL 3) 89	STILO L / XL (EXCLUSIVE 1) 89	STILO L / XL (EXCLUSIVE 2) 89	AERO 90		
					





LUMINARIAS INDUSTRIALES

ALUFORCE  	90	ALUFORCE/E  	90				
---	----	--	----	--	--	--	--



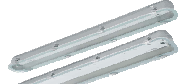

CAMPANAS INDUSTRIALES Y DECORATIVAS

POLYMARKET-565 	91	POLYMARKET-410 	91	POLYDECOR-410 	91	POLYTOP-415/IP44/G12 	92	ALUDECOR/BA-462 	92		
ALUDECOR/BR-462 	92	OBL-480-IP65 	92	OBL/F-480-IP65 	92	PGL/FA-IP65 	93	PGL/C-IP65 	93	PGL/C-IP54 	93
PGF/C 	93										



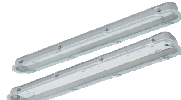

ESTANCAS IP65 CON TUBOS PHILIPS

ONIX/N-LED  	94	ACERO-LED  	95				
---	----	---	----	--	--	--	--

ESTANCAS IP65

ONIX/N 	94	JADE/N 	94	T5/RPC 	95	TOP-280 	95	ACERO 	95
---	----	---	----	---	----	---	----	--	----

ESTANCAS BAJAS TEMPERATURAS • TUNELES

FR-IP67  	96	TN-IP68  	96				
--	----	---	----	--	--	--	--

REGLETAS INDUSTRIALES

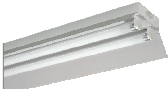
<p>PI/FA 96</p> 					
---	--	--	--	--	--



REGLETAS ESTANCAS IP65

<p>RET 97</p> 	<p>RET/P • TUBO PROTECTOR 97</p> 				
---	--	--	--	--	--



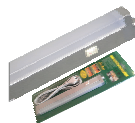

REGLETAS CON TUBOS PHILIPS

<p>RT-LED, RTL-LED 97</p> 					
--	--	--	--	--	--

REGLETAS EXTRA PLANAS / MINI FLUORESCENCIA

<p>SLIM-LED 98</p> 	<p>TLH-LED 98</p> 	<p>TKL 98</p> 	<p>TB-6 98</p> 		
--	---	---	--	--	--

REGLETAS • REFLECTORES • ACCESORIOS

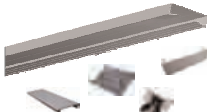
<p>RT 99</p> 	<p>REFLECTORES RT 99</p> 	<p>RT-5/MINI 99</p> 	<p>REFLECTORES RT-5/MINI 99</p> 	<p>CARRILES Y ACCESORIOS 100</p> 	
--	--	---	---	--	--

KIT DE EMERGENCIA MONTADOS EN LUMINARIAS

<p>MC-1, MC-3 100</p> 					
---	--	--	--	--	--

Catálogo
Tarifa
2013
ESP

SUSPENDIDAS



Materiales: Luminaria de alta gama y excelente acabado, en perfil de aluminio extruido, difusor microprismático + lumio.

CODIGO	REFERENCIA	Indice rendimiento de color CRI (Ra)	Temperatura de color CCT (k)	P.V.P.	Kg.
LSNL120	NAVKA-120W. 6600lm	>80	3000-6200	1.544,56 €	(5,5)

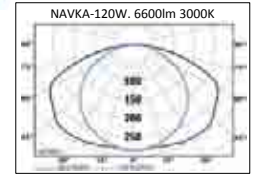
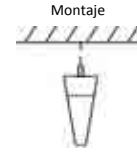

Suspensiones incluidas.

TUNABLE WHITE, significa que podemos modificar la temperatura de color.

En terminos de iluminación no hay un color blanco único, existen diferentes tonalidades de luz blanca.

Esta luminaria permite jugar con el blanco cálido, blanco neutro y blanco frío.

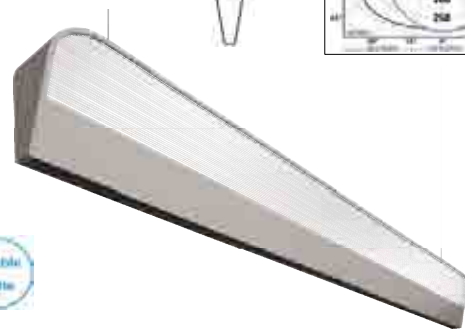
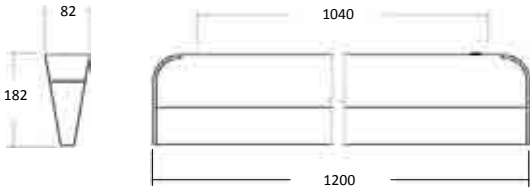

Materiales: Luminaria de alta gama y excelente acabado, en fundición de aluminio y chapa de acero, difusor opal.

CODIGO	REFERENCIA	Indice rendimiento de color CRI (Ra)	Temperatura de color CCT (k)	P.V.P.	Kg.
LSDL034	DIMA-34W. 3200lm/930	>90	3000	1.180,67 €	(5,7)
LSDL036	DIMA-36W. 4000lm/940	>90	4000	1.180,67 €	(5,7)

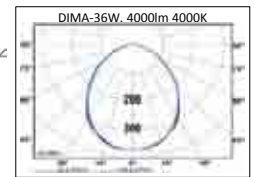
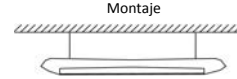

Suspensiones incluidas.

Equipo de control electrónico, bajo consulta equipo de control electrónico regulable (EE=A1 - DALI).

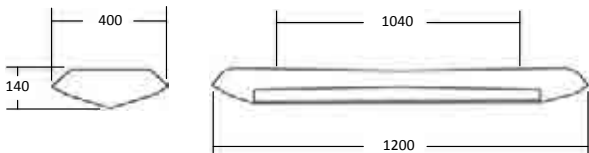

Materiales: Luminaria de alta gama y excelente acabado, en chapa de acero, difusor de PMMA opal + PMMA microprisma.

CODIGO	REFERENCIA	Indice rendimiento de color CRI (Ra)	Temperatura de color CCT (k)	P.V.P.	Kg.
13728L440	T5-OS-LED-59W. 4400lm/830	>80	3000	840,05 €	(6,7)
13728L465	T5-OS-LED-59W. 4650lm/840	>80	4000	840,05 €	(6,7)
13728L440G	T5-OS/GRIS-LED-59W. 4400lm/830	>80	3000	859,54 €	(6,7)
13728L465G	T5-OS/GRIS-LED-59W. 4650lm/840	>80	4000	859,54 €	(6,7)

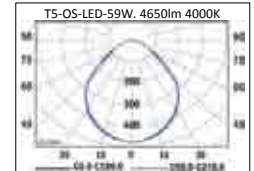
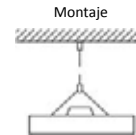

Suspensiones incluidas.

Equipo de control electrónico, bajo consulta equipo de control electrónico regulable (EE=A1 - DALI).



Materiales: Luminaria de suspensión o adosable de alta gama y excelente acabado, en chapa de acero RAL 9006, difusor de aluminio brillante.

CODIGO	REFERENCIA	Indice rendimiento de color CRI (Ra)	Temperatura de color CCT (k)	P.V.P.	Kg.
LSS0L115	SIAM-LED-16W. 1150lm/840	>80	4000	403,86 €	(2,5)

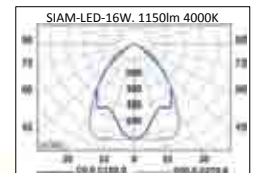
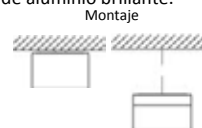

Suspensiones incluidas.

Equipo de control electrónico.





Materiales: Luminaria de suspensión o adosable de alta gama y excelente acabado, en chapa de acero RAL 9005, marco de aluminio extruido RAL 9006, difusor de PMMA opal + PMMA microprisma.

CODIGO	REFERENCIA	Indice rendimiento de color CRI (Ra)	Temperatura de color CCT (k)	P.V.P.	Kg.
LSB0L180	LEDBOX/L-35W. 1800lm/840	>80	4000	715,03 €	(2,7)

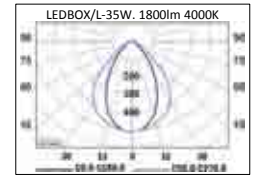
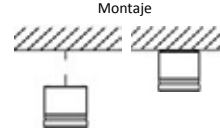

Suspensiones incluidas.

Equipo de control electrónico, bajo consulta equipo de control electrónico regulable (EE=A1 - DALI).

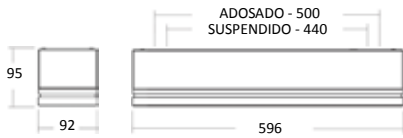
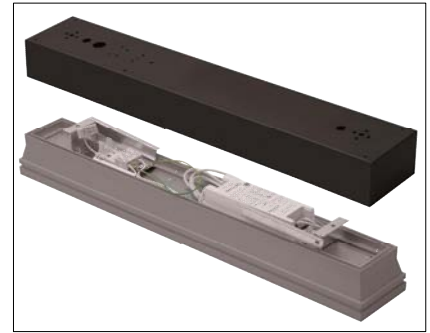
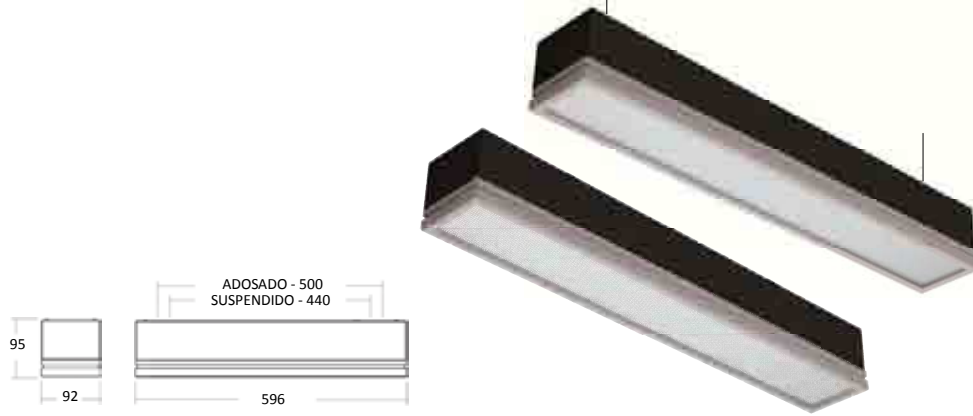

Materiales: Luminaria de alta gama y excelente acabado, en chapa de acero RAL 9005, marco de aluminio extruido RAL 9006, difusor directo de PMMA opal + PMMA microprisma.

CODIGO	REFERENCIA	Indice rendimiento de color CRI (Ra)	Temperatura de color CCT (k)	P.V.P.	Kg.
LSB1L420	LEDBOX-MAX/SUS-52W. 4200lm/830 (DIRECTA)	>80	3000	987,99 €	(9,5)
LSB1L421	LEDBOX-MAX/SUS-52W. 4200lm/840 (DIRECTA)	>80	4000	987,99 €	(9,5)
LSB2L535	LEDBOX-MAX/SUS-73W. 5350lm/830 (DIRECTA/INDIRECTA)	>80	3000	1.457,75 €	(9,5)
LSB2L536	LEDBOX-MAX/SUS-73W. 5350lm/840 (DIRECTA/INDIRECTA)	>80	4000	1.457,75 €	(9,5)

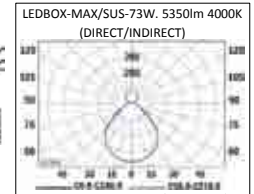
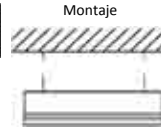

Suspensiones incluidas.

Equipo de control electrónico, bajo consulta equipo de control electrónico regulable (EE=A1 - DALI).

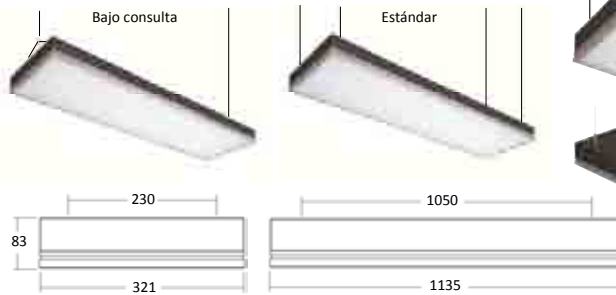

Directa/indirecta

Materiales: Luminaria de alta gama y excelente acabado, en chapa de acero RAL 9005, marco de aluminio extruido RAL 9006, difusor directo de PMMA opal + PMMA microprisma.

CODIGO	REFERENCIA	Indice rendimiento de color CRI (Ra)	Temperatura de color CCT (k)	P.V.P.	Kg.
LSB3L095	LEDBOX-C/SUS-14W. 950lm/830	>80	3000	629,21 €	(3,2)
LSB3L096	LEDBOX-C/SUS-14W. 950lm/840	>80	4000	629,21 €	(3,2)

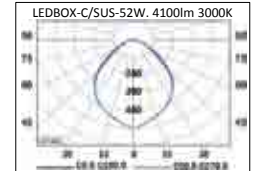
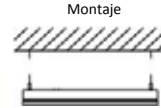

CODIGO	REFERENCIA	Indice rendimiento de color CRI (Ra)	Temperatura de color CCT (k)	P.V.P.	Kg.
LSB4L410	LEDBOX-C/SUS-52W. 4100lm/830	>80	3000	1.014,07 €	(8,5)
LSB4L411	LEDBOX-C/SUS-52W. 4100lm/840	>80	3000	1.014,07 €	(8,5)

Suspensiones incluidas.

Equipo de control electrónico, bajo consulta equipo de control electrónico regulable (EE=A1 - DALI).



SUSPENDIDAS

Materiales: Luminaria ultrafina de alta gama y excelente acabado, en perfil de aluminio pintado en color estandar gris RAL 9007.

CODIGO	REFERENCIA	P.V.P.	Kg.
15620375228	LIMIT-2x28W. H.F. (CDP)	418,88 €	(5,1)
15620375254	LIMIT-2x54W. H.F. (CDP)	418,88 €	(5,1)
15620375235	LIMIT-2x35W. H.F. (CDP)	465,71 €	(6,3)
15620375249	LIMIT-2x49W. H.F. (CDP)	465,71 €	(6,3)
15620375280	LIMIT-2x80W. H.F. (CDP)	507,12 €	(6,3)
15620375428	LIMIT-4x28W. H.F. (CDP)	459,70 €	(5,1)
15620375435	LIMIT-4x35W. H.F. (CDP)	508,38 €	(6,3)

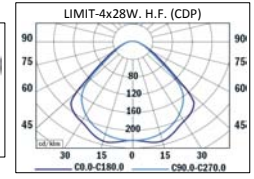

228/254/428W. - L=1218, Y=1125
235/249/280/435W. - L=1518, Y=1425

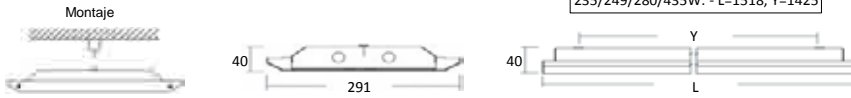

Materiales: Luminaria de alta gama y excelente acabado, en perfil de aluminio pintado en color estandar gris RAL 9007.

CODIGO	REFERENCIA	P.V.P.	Kg.
15620383228	EXTREME/MICROPRISMA-CONICO-2x28W. H.F. (CDP)	522,71 €	(3,9)
15620383254	EXTREME/MICROPRISMA-CONICO-2x54W. H.F. (CDP)	522,71 €	(3,9)
15620383235	EXTREME/MICROPRISMA-CONICO-2x35W. H.F. (CDP)	593,04 €	(4,8)
15620383249	EXTREME/MICROPRISMA-CONICO-2x49W. H.F. (CDP)	593,04 €	(4,8)

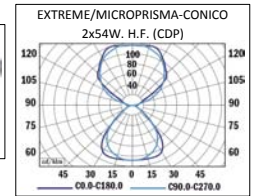

LOR= 55.73%

156203832281	EXTREME/MICROPRISMA-LINEAL-2x28W. H.F. (LDP)	566,25 €	(3,9)
156203832541	EXTREME/MICROPRISMA-LINEAL-2x54W. H.F. (LDP)	566,25 €	(3,9)
156203832351	EXTREME/MICROPRISMA-LINEAL-2x35W. H.F. (LDP)	642,48 €	(4,8)
156203832491	EXTREME/MICROPRISMA-LINEAL-2x49W. H.F. (LDP)	642,48 €	(4,8)

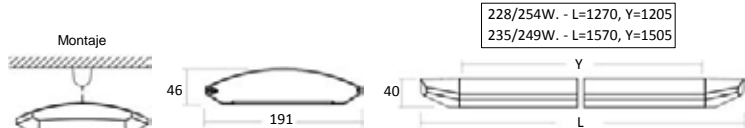

228/254W. - L=1270, Y=1205
235/249W. - L=1570, Y=1505

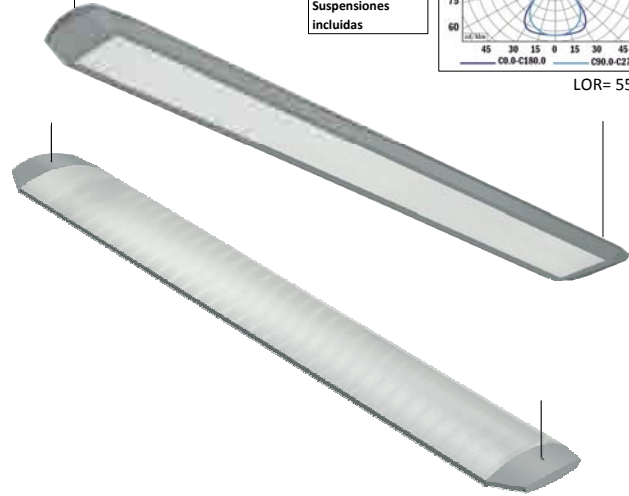
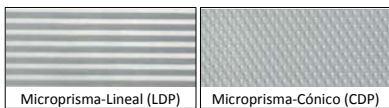

Materiales: Luminaria de alta gama y excelente acabado, en chapa de acero.

CODIGO	REFERENCIA	P.V.P.	Kg.
1562025328	T5-GL-3x28W. H.F.	224,86 €	(7,2)
1562025354	T5-GL-3x54W. H.F.	224,86 €	(7,2)
1562025335	T5-GL-3x35W. H.F.	250,01 €	(9,0)
1562025349	T5-GL-3x49W. H.F.	250,01 €	(9,0)

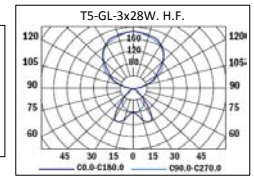

LOR= 90.23%

1562025328G	T5-GL/GRIS-3x28W. H.F.	241,75 €	(7,2)
1562025354G	T5-GL/GRIS-3x54W. H.F.	241,75 €	(7,2)
1562025335G	T5-GL/GRIS-3x35W. H.F.	264,58 €	(9,0)
1562025349G	T5-GL/GRIS-3x49W. H.F.	264,58 €	(9,0)

156203000001B	INTERRUPTOR TIRADOR "PULL SWITCH" BLANCO	56,32 €	-
---------------	--	---------	---



328/354W. - L=1250, Y=1130
335/349W. - L=1550, Y=1430

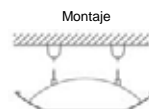

SUSPENDIDAS

Materiales: Luminaria de alta gama y excelente acabado, en chapa de acero.

CODIGO	REFERENCIA	P.V.P.	Kg.
03620403328	T5-R-3x28W. H.F.	205,83 €	(6,5)
03620403354	T5-R-3x54W. H.F.	205,83 €	(6,5)

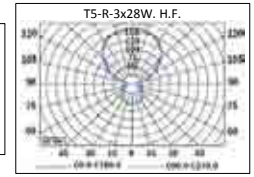
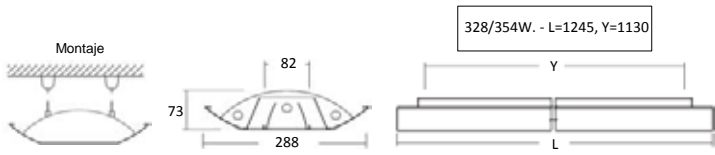

LOR= 90.23%

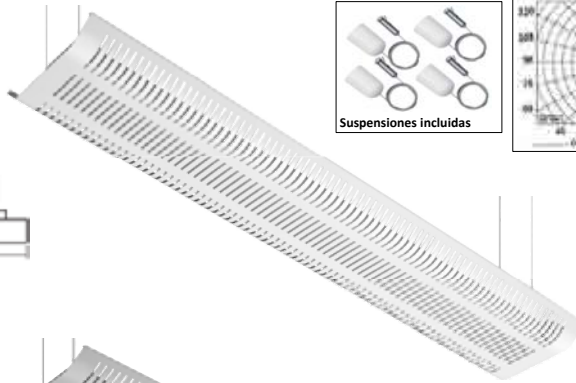

03620403328G	T5-R/GRIS-3x28W. H.F.	222,72 €	(6,5)
03620403354G	T5-R/GRIS-3x54W. H.F.	222,72 €	(6,5)

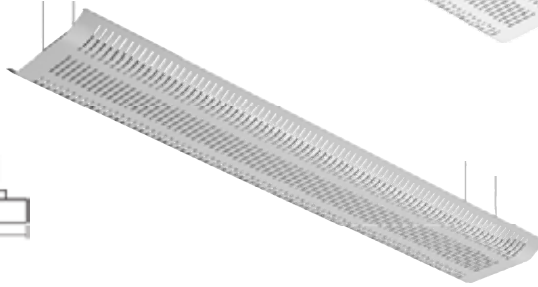
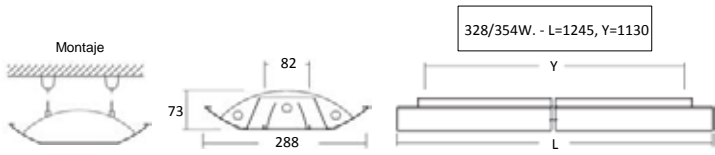

Materiales: Luminaria de alta gama y excelente acabado, en perfil de aluminio extruido.

CODIGO	REFERENCIA	P.V.P.	Kg.
156203015228	T5-SBTN-2x28W. H.F. (DIRECTA)	452,21 €	(7,6)
156203015254	T5-SBTN-2x54W. H.F. (DIRECTA)	452,21 €	(7,6)
156203015235	T5-SBTN-2x35W. H.F. (DIRECTA)	511,83 €	(9,4)
156203015249	T5-SBTN-2x49W. H.F. (DIRECTA)	511,83 €	(9,4)
156203015280	T5-SBTN-2x80W. H.F. (DIRECTA)	558,19 €	(9,4)

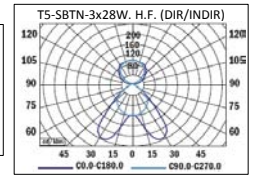

LOR= 63.94%

1562030153281	T5-SBTN-3x28W. H.F. (DIRECTA/INDIRECTA)	517,68 €	(7,9)
1562030153541	T5-SBTN-3x54W. H.F. (DIRECTA/INDIRECTA)	517,68 €	(7,9)
1562030153351	T5-SBTN-3x35W. H.F. (DIRECTA/INDIRECTA)	597,90 €	(9,7)
1562030153491	T5-SBTN-3x49W. H.F. (DIRECTA/INDIRECTA)	597,90 €	(9,7)

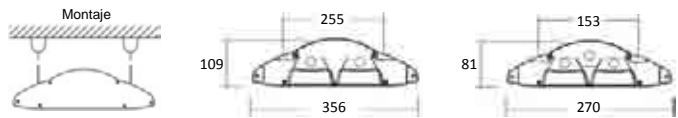
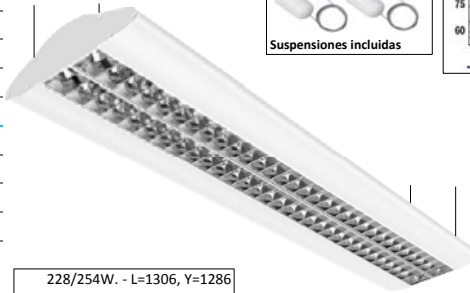

228/254W. - L=1306, Y=1286
 235/249/280W. - L=1610, Y=1590
 328/354W. - L=1192, Y=1174
 335/349W. - L=1492, Y=1474

156203015228G	T5-SBTN/GRIS-2x28W. H.F. (DIRECTA)	470,40 €	(7,6)
156203015254G	T5-SBTN/GRIS-2x54W. H.F. (DIRECTA)	470,40 €	(7,6)
156203015235G	T5-SBTN/GRIS-2x35W. H.F. (DIRECTA)	530,03 €	(9,4)
156203015249G	T5-SBTN/GRIS-2x49W. H.F. (DIRECTA)	530,03 €	(9,4)
156203015280G	T5-SBTN/GRIS-2x80W. H.F. (DIRECTA)	576,38 €	(9,4)

1562030153281G	T5-SBTN/GRIS-3x28W. H.F.	535,88 €	(7,9)
1562030153541G	T5-SBTN/GRIS-3x54W. H.F.	535,88 €	(7,9)
1562030153351G	T5-SBTN/GRIS-3x35W. H.F.	616,10 €	(9,7)
1562030153491G	T5-SBTN/GRIS-3x49W. H.F.	616,10 €	(9,7)



156203000001B	INTERRUPTOR TIRADOR "PULL SWITCH" BLANCO	56,32 €	-
---------------	---	----------------	---

(incrementar al precio de la luminaria)

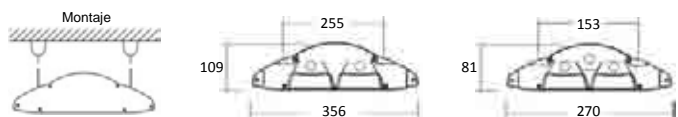

228/254W. - L=1306, Y=1286
 235/249/280W. - L=1610, Y=1590
 328/354W. - L=1192, Y=1174
 335/349W. - L=1492, Y=1474



SUSPENDIDAS

Materiales: Luminaria de alta gama y excelente acabado, en perfil de aluminio extruido en color natural.

CODIGO	REFERENCIA	P.V.P.	Kg.
15620315128	T5-L-1x28W. H.F.	226,41 €	(2,5)
15620315154	T5-L-1x54W. H.F.	226,41 €	(2,5)
15620315135	T5-L-1x35W. H.F.	272,80 €	(3,1)
15620315149	T5-L-1x49W. H.F.	272,80 €	(3,1)
15620315180	T5-L-1x80W. H.F.	288,30 €	(3,1)
15620315228	T5-L-2x28W. H.F.	280,82 €	(3,7)
15620315254	T5-L-2x54W. H.F.	280,82 €	(3,7)
15620315235	T5-L-2x35W. H.F.	313,88 €	(4,6)
15620315249	T5-L-2x49W. H.F.	313,88 €	(4,6)
15620315280	T5-L-2x80W. H.F.	358,47 €	(4,6)
15620315414	T5-L-4x14W. H.F.	254,59 €	(4,2)
15620315424	T5-L-4x24W. H.F.	282,13 €	(4,2)

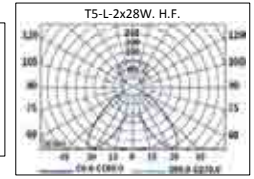
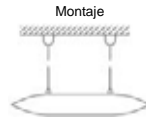

LOR = 87.89%

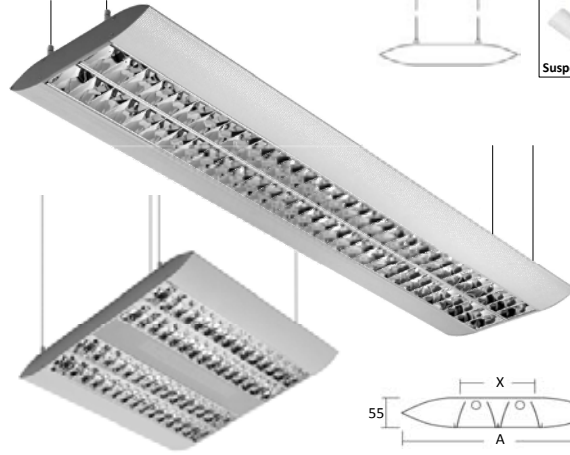

128/154W. - A=250, L=1188, X= 62, Y=1159
 135/149/180W. - A=250, L=1488, X= 62, Y=1459
 228/254W. - A=330, L=1188, X=142, Y=1159
 235/249/280W. - A=330, L=1488, X=142, Y=1459
 414/424W. - A=570, L= 590, X=373, Y= 489

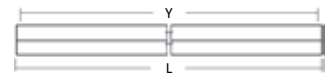
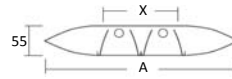

LINEAS CONTINUAS EN PAG. 10

Materiales: Luminaria de alta gama y excelente acabado, en perfil de aluminio extruido en color natural.

CODIGO	REFERENCIA	P.V.P.	Kg.
15620335228	T5-L/MICROPRISMA-CONICO-2x28W. H.F. (CDP)	351,80 €	(3,7)
15620335254	T5-L/MICROPRISMA-CONICO-2x54W. H.F. (CDP)	351,80 €	(3,7)
15620335235	T5-L/MICROPRISMA-CONICO-2x35W. H.F. (CDP)	351,80 €	(3,7)
15620335249	T5-L/MICROPRISMA-CONICO-2x49W. H.F. (CDP)	351,80 €	(3,7)
15620335280	T5-L/MICROPRISMA-CONICO-2x80W. H.F. (CDP)	351,80 €	(3,7)
15620335328	T5-L/MICROPRISMA-CONICO-3x28W. H.F. (CDP)	351,80 €	(3,7)
15620335335	T5-L/MICROPRISMA-CONICO-3x35W. H.F. (CDP)	351,80 €	(3,7)
15620345228	T5-L/MICROPRISMA-LINEAL-2x28W. H.F. (LDP)	497,46 €	(3,7)
15620345254	T5-L/MICROPRISMA-LINEAL-2x54W. H.F. (LDP)	497,46 €	(3,7)
15620345235	T5-L/MICROPRISMA-LINEAL-2x35W. H.F. (LDP)	546,23 €	(3,7)
15620345249	T5-L/MICROPRISMA-LINEAL-2x49W. H.F. (LDP)	546,23 €	(3,7)
15620345280	T5-L/MICROPRISMA-LINEAL-2x80W. H.F. (LDP)	588,89 €	(3,7)
15620345328	T5-L/MICROPRISMA-LINEAL-3x28W. H.F. (LDP)	554,12 €	(3,7)
15620345335	T5-L/MICROPRISMA-LINEAL-3x35W. H.F. (LDP)	600,49 €	(3,7)

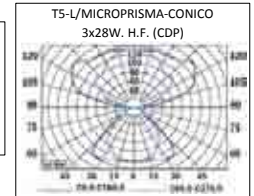

LOR = 86.36%

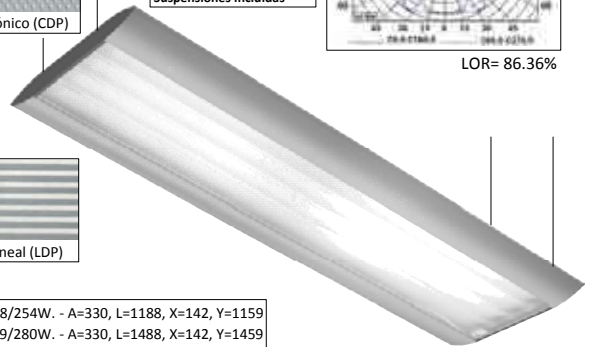

228/254W. - A=330, L=1188, X=142, Y=1159
 235/249/280W. - A=330, L=1488, X=142, Y=1459
 328W. - A=390, L=1188, X=201, Y=1159
 335W. - A=390, L=1488, X=201, Y=1459

LINEAS CONTINUAS EN PAG. 10

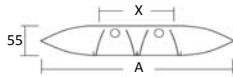
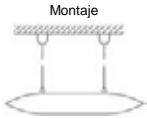

Materiales: Luminaria suspension o adosable de alta gama y excelente acabado, en chapa de acero.

CODIGO	REFERENCIA	P.V.P.	Kg.
15620415128	EVOLUTION-1x28W. H.F. (DIRECTA/INDIRECTA)	200,84 €	(3,1)
15620415154	EVOLUTION-1x54W. H.F. (DIRECTA/INDIRECTA)	200,84 €	(3,1)
15620415135	EVOLUTION-1x35W. H.F. (DIRECTA/INDIRECTA)	217,79 €	(3,6)
15620415149	EVOLUTION-1x49W. H.F. (DIRECTA/INDIRECTA)	217,79 €	(3,6)
15620415180	EVOLUTION-1x80W. H.F. (DIRECTA/INDIRECTA)	223,62 €	(3,6)
15620415228	EVOLUTION-2x28W. H.F. (DIRECTA/INDIRECTA)	209,01 €	(3,2)
15620415254	EVOLUTION-2x54W. H.F. (DIRECTA/INDIRECTA)	209,01 €	(3,2)
15620415235	EVOLUTION-2x35W. H.F. (DIRECTA/INDIRECTA)	225,39 €	(3,7)
15620415249	EVOLUTION-2x49W. H.F. (DIRECTA/INDIRECTA)	225,39 €	(3,7)
15620415280	EVOLUTION-2x80W. H.F. (DIRECTA/INDIRECTA)	266,22 €	(3,7)
15620415128G	EVOLUTION/GRIS-1x28W. H.F. (DIRECTA/INDIRECTA)	217,74 €	(3,1)
15620415154G	EVOLUTION/GRIS-1x54W. H.F. (DIRECTA/INDIRECTA)	217,74 €	(3,1)
15620415135G	EVOLUTION/GRIS-1x35W. H.F. (DIRECTA/INDIRECTA)	234,69 €	(3,6)
15620415149G	EVOLUTION/GRIS-1x49W. H.F. (DIRECTA/INDIRECTA)	234,69 €	(3,6)
15620415180G	EVOLUTION/GRIS-1x80W. H.F. (DIRECTA/INDIRECTA)	240,52 €	(3,6)
15620415228G	EVOLUTION/GRIS-2x28W. H.F. (DIRECTA/INDIRECTA)	225,90 €	(3,2)
15620415254G	EVOLUTION/GRIS-2x54W. H.F. (DIRECTA/INDIRECTA)	225,90 €	(3,2)
15620415235G	EVOLUTION/GRIS-2x35W. H.F. (DIRECTA/INDIRECTA)	242,29 €	(3,7)
15620415249G	EVOLUTION/GRIS-2x49W. H.F. (DIRECTA/INDIRECTA)	242,29 €	(3,7)
15620415280G	EVOLUTION/GRIS-2x80W. H.F. (DIRECTA/INDIRECTA)	283,12 €	(3,7)

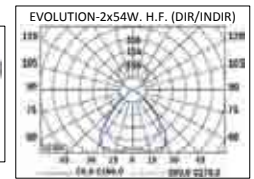
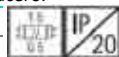

LOR = 69.79%

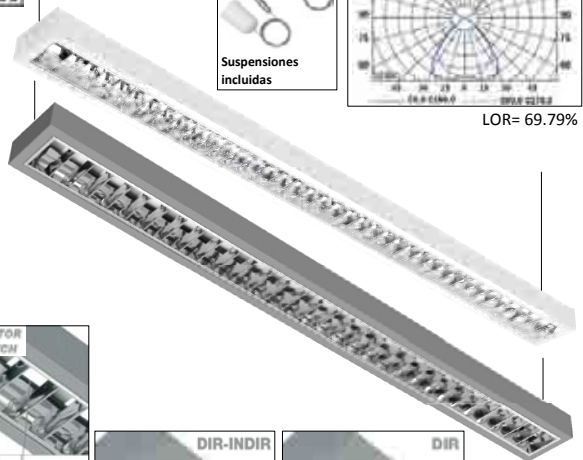

EVOLUTION (DIRECTA), mismo precio.

15620300001B	INTERRUPTOR TIRADOR "PULL SWITCH" BLANCO	56,32 €	-
--------------	--	---------	---

Montaje

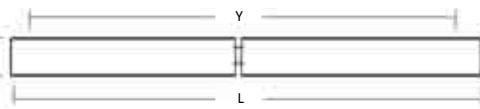
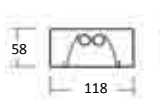
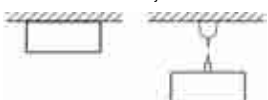

128/154/228/254W. - L=1206, Y= 1105
 135/149/180/235/249/280W. - L=1506, Y=1405

LINEAS CONTINUAS EN PAG. 11

SUSPENDIDAS

Materiales: Luminaria de alta gama y excelente acabado, en chapa de acero.

CODIGO	REFERENCIA	P.V.P.	Kg.
137275128	T5-X-1x28W. H.F. (DIRECTA)	187,71 €	(4,2)
137275154	T5-X-1x54W. H.F. (DIRECTA)	187,71 €	(4,2)
137275135	T5-X-1x35W. H.F. (DIRECTA)	207,10 €	(4,9)
137275149	T5-X-1x49W. H.F. (DIRECTA)	207,10 €	(4,9)
137275180	T5-X-1x80W. H.F. (DIRECTA)	209,64 €	(4,9)
137275228	T5-X-2x28W. H.F. (DIRECTA)	215,59 €	(5,5)
137275254	T5-X-2x54W. H.F. (DIRECTA)	215,59 €	(5,5)
137275235	T5-X-2x35W. H.F. (DIRECTA)	240,89 €	(6,2)
137275249	T5-X-2x49W. H.F. (DIRECTA)	240,89 €	(6,2)
137275280	T5-X-2x80W. H.F. (DIRECTA)	285,66 €	(6,2)

T5-X (DIRECTA/INDIRECTA), BAJO CONSULTA.

137275128G	T5-X/GRIS-1x28W. H.F. (DIRECTA)	204,60 €	(4,2)
137275154G	T5-X/GRIS-1x54W. H.F. (DIRECTA)	204,60 €	(4,2)
137275135G	T5-X/GRIS-1x35W. H.F. (DIRECTA)	224,00 €	(4,9)
137275149G	T5-X/GRIS-1x49W. H.F. (DIRECTA)	224,00 €	(4,9)
137275180G	T5-X/GRIS-1x80W. H.F. (DIRECTA)	226,53 €	(4,9)
137275228G	T5-X/GRIS-2x28W. H.F. (DIRECTA)	232,48 €	(5,5)
137275254G	T5-X/GRIS-2x54W. H.F. (DIRECTA)	232,48 €	(5,5)
137275235G	T5-X/GRIS-2x35W. H.F. (DIRECTA)	257,79 €	(6,2)
137275249G	T5-X/GRIS-2x49W. H.F. (DIRECTA)	257,79 €	(6,2)
137275280G	T5-X/GRIS-2x80W. H.F. (DIRECTA)	302,48 €	(6,2)

T5-X/GRIS (DIRECTA/INDIRECTA), BAJO CONSULTA.

156203000001B	INTERRUPTOR TIRADOR "PULL SWITCH" BLANCO	56,32 €	-
---	SENSOR	BAJO CONSULTA	

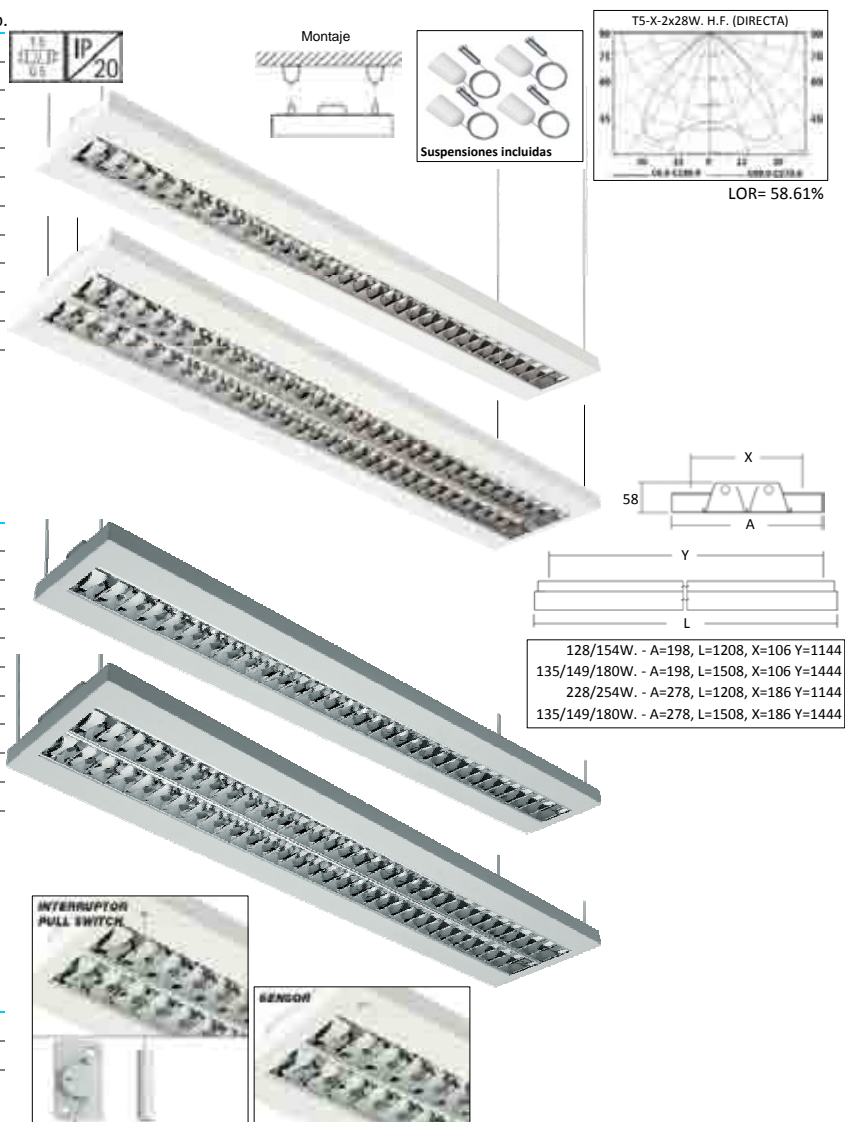

Materiales: Luminaria de alta gama y excelente acabado, en chapa de acero.

CODIGO	REFERENCIA	P.V.P.	Kg.
137285328	T5-OS-3x28W. H.F.	234,57 €	(4,8)
137285354	T5-OS-3x54W. H.F.	234,57 €	(4,8)
137285335	T5-OS-3x35W. H.F.	267,21 €	(5,9)
137285349	T5-OS-3x49W. H.F.	267,21 €	(5,9)

137285328G	T5-OS/GRIS-3x28W. H.F.	251,47 €	(4,8)
137285354G	T5-OS/GRIS-3x54W. H.F.	251,47 €	(4,8)
137285335G	T5-OS/GRIS-3x35W. H.F.	284,10 €	(5,9)
137285349G	T5-OS/GRIS-3x49W. H.F.	284,10 €	(5,9)

156203000001B	INTERRUPTOR TIRADOR "PULL SWITCH" BLANCO	56,32 €	-
---	SENSOR	BAJO CONSULTA	

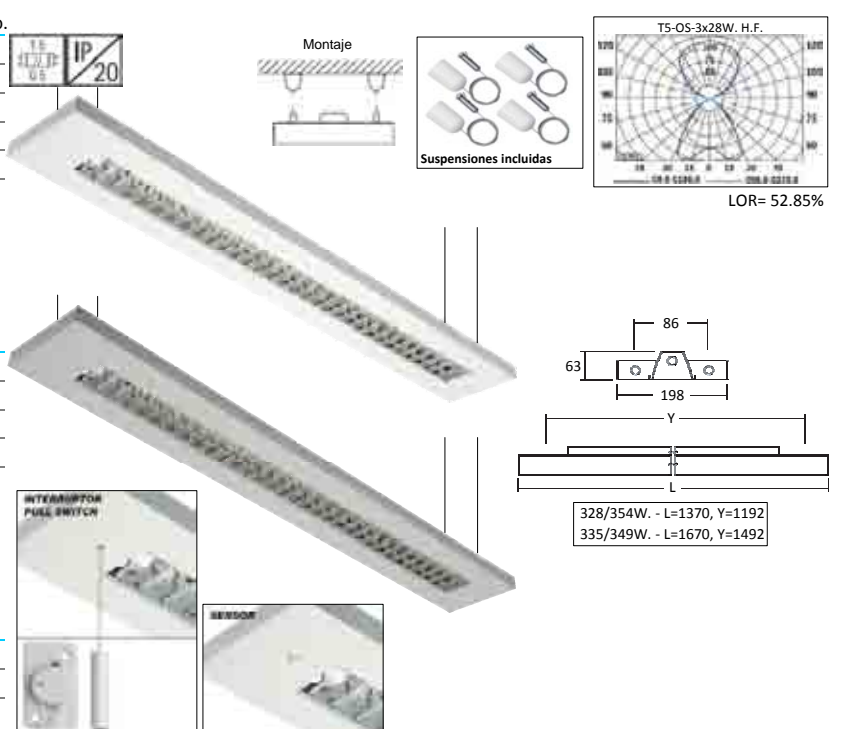

SUSPENDIDAS

Materiales: Luminaria de alta gama y excelente acabado, en chapa de acero con cristal marco esmerilado.

CODIGO	REFERENCIA	P.V.P.	Kg.
137285328	T5-OS/GL-3x28W. H.F.	469,53 €	(5,5)
137285354	T5-OS/GL-3x54W. H.F.	469,53 €	(5,5)
137285335	T5-OS/GL-3x35W. H.F.	506,38 €	(6,7)
137285349	T5-OS/GL-3x49W. H.F.	506,38 €	(6,7)

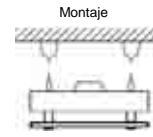

137285328G	T5-OS/GL/GRIS-3x28W. H.F.	486,42 €	(5,5)
137285354G	T5-OS/GL/GRIS-3x54W. H.F.	486,42 €	(5,5)
137285335G	T5-OS/GL/GRIS-3x35W. H.F.	523,27 €	(6,7)
137285349G	T5-OS/GL/GRIS-3x49W. H.F.	523,27 €	(6,7)

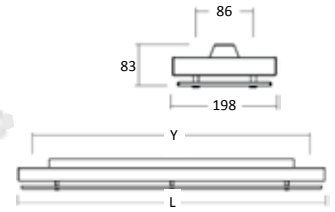
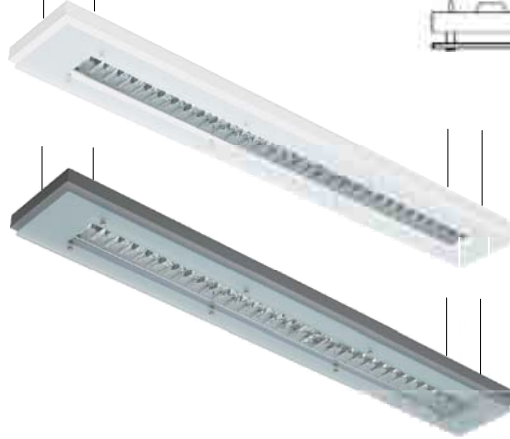

328/354W. - L=1370, Y=1192
335/349W. - L=1670, Y=1492

Materiales: Luminaria de alta gama y excelente acabado, en chapa de acero con cristal difusor esmerilado.

CODIGO	REFERENCIA	P.V.P.	Kg.
137285328	T5-OS/GLS-3x28W. H.F.	430,67 €	(5,6)
137285354	T5-OS/GLS-3x54W. H.F.	430,67 €	(5,6)
137285335	T5-OS/GLS-3x35W. H.F.	462,45 €	(6,8)
137285349	T5-OS/GLS-3x49W. H.F.	462,45 €	(6,8)

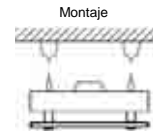

Difusor parabólico no incluido.

137285328G	T5-OS/GLS/GRIS-3x28W. H.F.	447,57 €	(5,6)
137285354G	T5-OS/GLS/GRIS-3x54W. H.F.	447,57 €	(5,6)
137285335G	T5-OS/GLS/GRIS-3x35W. H.F.	479,35 €	(6,8)
137285349G	T5-OS/GLS/GRIS-3x49W. H.F.	479,35 €	(6,8)

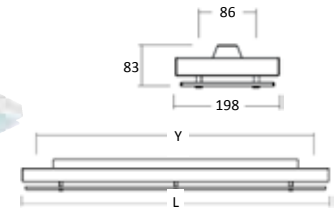
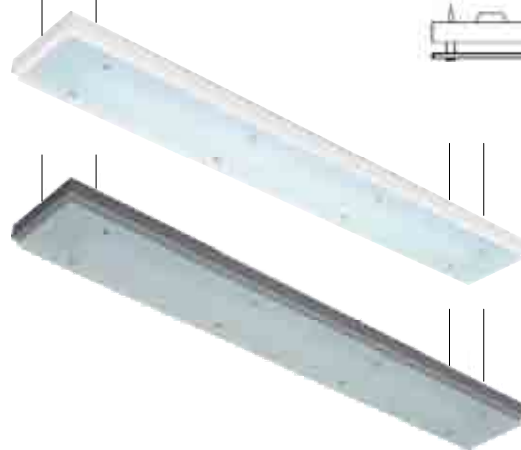

328/354W. - L=1370, Y=1192
335/349W. - L=1670, Y=1492

Materiales: Luminaria suspendida, en perfil de aluminio con cabezales en clapa de acero.

CODIGO	REFERENCIA	P.V.P.	Kg.
15820002236	T8-S-2x36W. 230V. A.F.	229,50 €	(5,3)
15820002258	T8-S-2x58W. 230V. A.F.	262,69 €	(7,0)
15820003236	T8-S-2x36W. H.F.	238,63 €	(4,3)
15820003258	T8-S-2x58W. H.F.	273,14 €	(5,2)

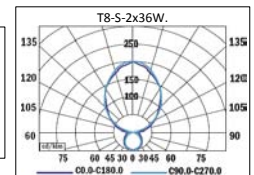
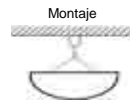
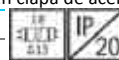

LOR= 54.00%

Accesorios para formar líneas continuas incluidos.

15820002236G	T8-S/GRIS-2x36W. 230V. A.F.	229,50 €	(5,3)
15820002258G	T8-S/GRIS-2x58W. 230V. A.F.	262,69 €	(7,0)
15820003236G	T8-S/GRIS-2x36W. H.F.	238,63 €	(4,3)
15820003258G	T8-S/GRIS-2x58W. H.F.	273,14 €	(5,2)

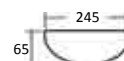
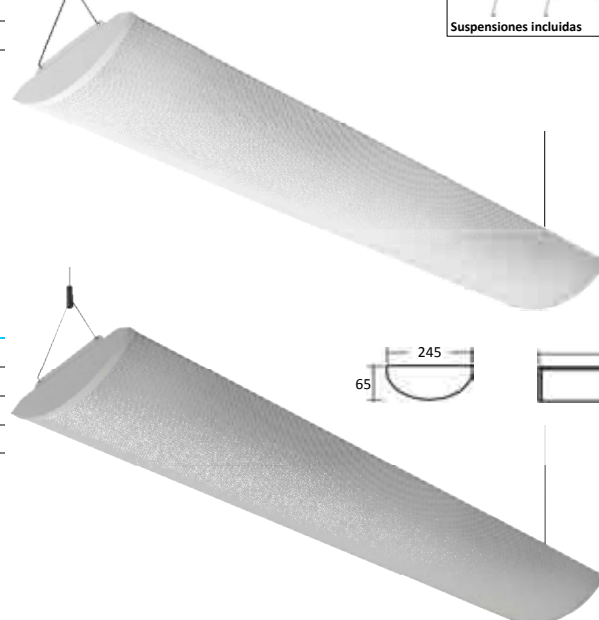

236W. - L=1260
258W. - L=1555

Accesorios para formar líneas continuas incluidos.

SUSPENDIDAS

Materiales: Luminaria suspendida en chapa de acero, difusor lamas brillantes.

CODIGO	REFERENCIA	P.V.P.	Kg.
1372144228	AVATAR-2x28W. H.F.	168,53 €	(3,5)
1372144254	AVATAR-2x54W. H.F.	168,53 €	(3,5)
1372144235	AVATAR-2x35W. H.F.	181,85 €	(4,3)
1372144249	AVATAR-2x49W. H.F.	181,85 €	(4,3)
1372144280	AVATAR-2x80W. H.F.	218,77 €	(4,3)

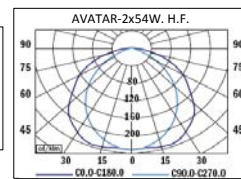
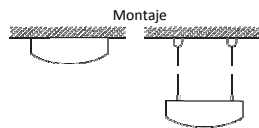
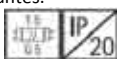

LOR= 61.40%

1372144228G	AVATAR/GRIS-2x28W. H.F.	185,43 €	(3,5)
1372144254G	AVATAR/GRIS-2x54W. H.F.	185,43 €	(3,5)
1372144235G	AVATAR/GRIS-2x35W. H.F.	198,74 €	(4,3)
1372144249G	AVATAR/GRIS-2x49W. H.F.	198,74 €	(4,3)
1372144280G	AVATAR/GRIS-2x80W. H.F.	235,67 €	(4,3)

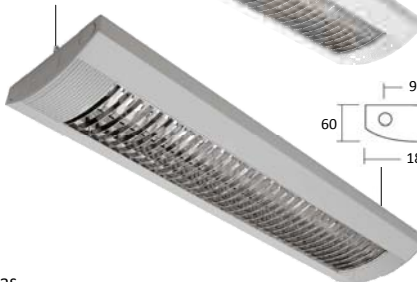

228/254W. - L=1310 S= 800
235/249/280W. - L=1610

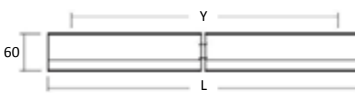
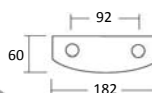

Materiales: Luminaria suspendida en chapa de acero, difusor lamas blancas.

CODIGO	REFERENCIA	P.V.P.	Kg.
13721442281	AVATAR/LV-2x28W. H.F.	168,53 €	(3,5)
13721442541	AVATAR/LV-2x54W. H.F.	168,53 €	(3,5)
13721442351	AVATAR/LV-2x35W. H.F.	181,85 €	(4,3)
13721442491	AVATAR/LV-2x49W. H.F.	181,85 €	(4,3)
13721442801	AVATAR/LV-2x80W. H.F.	218,77 €	(4,3)

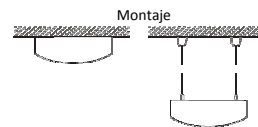

13721442281G	AVATAR/LV/GRIS-2x28W. H.F.	185,43 €	(3,5)
13721442541G	AVATAR/LV/GRIS-2x54W. H.F.	185,43 €	(3,5)
13721442351G	AVATAR/LV/GRIS-2x35W. H.F.	198,74 €	(4,3)
13721442491G	AVATAR/LV/GRIS-2x49W. H.F.	198,74 €	(4,3)
13721442801G	AVATAR/LV/GRIS-2x80W. H.F.	235,67 €	(4,3)

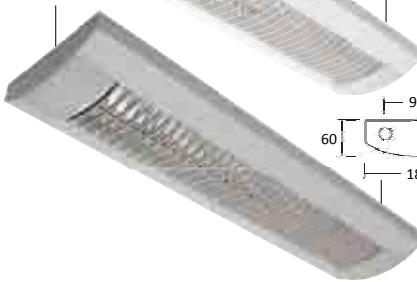

228/254W. - L=1310 S= 800
235/249/280W. - L=1610

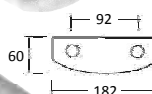

Materiales: Luminaria suspendida en chapa de acero, difusor prismático.

CODIGO	REFERENCIA	P.V.P.	Kg.
1372154228	AVATAR/PRISMA-2x28W. H.F.	174,41 €	(3,5)
1372154254	AVATAR/PRISMA-2x54W. H.F.	174,41 €	(3,5)
1372154235	AVATAR/PRISMA-2x35W. H.F.	185,83 €	(4,3)
1372154249	AVATAR/PRISMA-2x49W. H.F.	185,83 €	(4,3)
1372154280	AVATAR/PRISMA-2x80W. H.F.	225,37 €	(4,3)

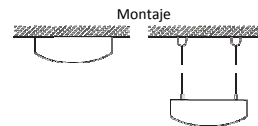

1372154228G	AVATAR/PRISMA/GRIS-2x28W. H.F.	191,30 €	(3,5)
1372154254G	AVATAR/PRISMA/GRIS-2x54W. H.F.	191,30 €	(3,5)
1372154235G	AVATAR/PRISMA/GRIS-2x35W. H.F.	202,72 €	(4,3)
1372154249G	AVATAR/PRISMA/GRIS-2x49W. H.F.	202,72 €	(4,3)
1372154280G	AVATAR/PRISMA/GRIS-2x80W. H.F.	242,26 €	(4,3)



228/254W. - L=1310 S= 800
235/249/280W. - L=1610

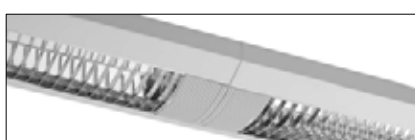
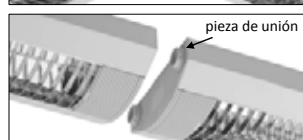
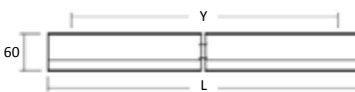
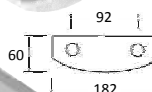

ACCESORIOS (Color blanco)

1372140001	CONEXIÓN CIRCULAR AVATAR (Disco+brazos)	36,88 €	-
1372140003	CONEXIÓN UNION AVATAR (2 Uds)	4,31 €	-

SUSPENDIDAS

Materiales: Luminaria suspendida, en aluminio extruido pintado en color gris, difusor brillante.

CODIGO	REFERENCIA	P.V.P.	Kg.
03620033128	FUTUR/BR-1x28W. H.F.	274,23 €	(3,3)
03620033154	FUTUR/BR-1x54W. H.F.	274,23 €	(3,3)
03620033135	FUTUR/BR-1x35W. H.F.	306,64 €	(4,2)
03620033149	FUTUR/BR-1x49W. H.F.	306,64 €	(4,2)
03620033180	FUTUR/BR-1x80W. H.F.	310,23 €	(4,2)
03620033228	FUTUR/BR-2x28W. H.F.	280,17 €	(3,6)
03620033254	FUTUR/BR-2x54W. H.F.	280,17 €	(3,6)
03620033235	FUTUR/BR-2x35W. H.F.	313,01 €	(4,5)
03620033249	FUTUR/BR-2x49W. H.F.	313,01 €	(4,5)



128/154/228/254W. - L=1250, Y=1200
135/149/180/235/249W. - L=1550, Y=1500

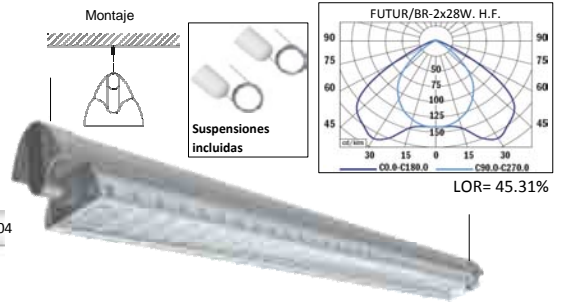
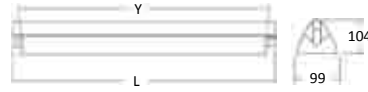

Materiales: Luminaria suspendida, en aluminio extruido pintado en color gris, difusor mate.

CODIGO	REFERENCIA	P.V.P.	Kg.
03620043128	FUTUR/MR-1x28W. H.F.	270,12 €	(3,3)
03620043154	FUTUR/MR-1x54W. H.F.	270,12 €	(3,3)
03620043135	FUTUR/MR-1x35W. H.F.	307,59 €	(4,2)
03620043149	FUTUR/MR-1x49W. H.F.	307,59 €	(4,2)
03620043180	FUTUR/MR-1x80W. H.F.	311,53 €	(4,2)
03620043228	FUTUR/MR-2x28W. H.F.	280,95 €	(3,6)
03620043254	FUTUR/MR-2x54W. H.F.	280,95 €	(3,6)
03620043235	FUTUR/MR-2x35W. H.F.	313,92 €	(4,5)
03620043249	FUTUR/MR-2x49W. H.F.	313,92 €	(4,5)

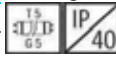

128/154/228/254W. - L=1250, Y=1200
135/149/180/235/249W. - L=1550, Y=1500

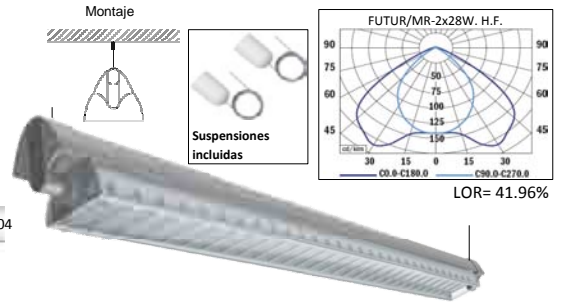

Materiales: Luminaria suspendida, en aluminio extruido pintado en color gris, difusor opal.

CODIGO	REFERENCIA	P.V.P.	Kg.
03620063128	FUTUR/OPAL-1x28W. H.F.	255,30 €	(3,3)
03620063154	FUTUR/OPAL-1x54W. H.F.	255,30 €	(3,3)
03620063135	FUTUR/OPAL-1x35W. H.F.	284,89 €	(4,2)
03620063149	FUTUR/OPAL-1x49W. H.F.	284,89 €	(4,2)
03620063180	FUTUR/OPAL-1x80W. H.F.	287,02 €	(4,2)
03620063228	FUTUR/OPAL-2x28W. H.F.	262,19 €	(3,6)
03620063254	FUTUR/OPAL-2x54W. H.F.	262,19 €	(3,6)
03620063235	FUTUR/OPAL-2x35W. H.F.	289,79 €	(4,5)
03620063249	FUTUR/OPAL-2x49W. H.F.	289,79 €	(4,5)

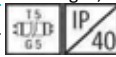

128/154/228/254W. - L=1250, Y=1200
135/149/180/235/249W. - L=1550, Y=1500

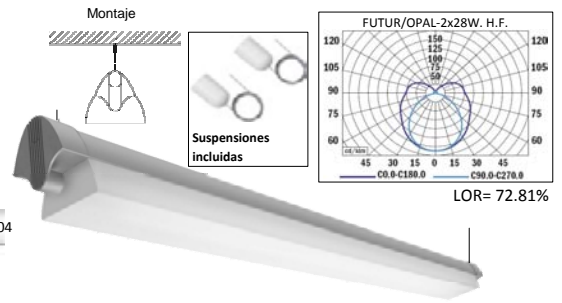

Materiales: Luminaria suspendida, en aluminio extruido pintado en color gris, reflector simétrico.

CODIGO	REFERENCIA	P.V.P.	Kg.
03620013128	FUTUR/SYM-1x28W. H.F.	243,74 €	(3,3)
03620013154	FUTUR/SYM-1x54W. H.F.	243,74 €	(3,3)
03620013135	FUTUR/SYM-1x35W. H.F.	272,85 €	(4,2)
03620013149	FUTUR/SYM-1x49W. H.F.	272,85 €	(4,2)
03620013180	FUTUR/SYM-1x80W. H.F.	276,79 €	(4,2)
03620013228	FUTUR/SYM-2x28W. H.F.	250,06 €	(3,6)
03620013254	FUTUR/SYM-2x54W. H.F.	250,06 €	(3,6)
03620013235	FUTUR/SYM-2x35W. H.F.	279,22 €	(4,5)
03620013249	FUTUR/SYM-2x49W. H.F.	279,22 €	(4,5)
03620013280	FUTUR/SYM-2x80W. H.F.	327,78 €	(4,5)

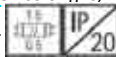

128/154/228/254W. - L=1250, Y=1200
135/149/180/235/249/280W. - L=1550, Y=1500

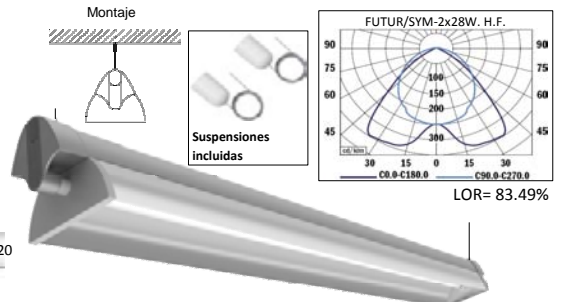
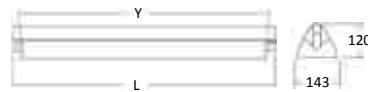

Materiales: Luminaria suspendida, en aluminio extruido pintado en color gris, reflector asimétrico.

CODIGO	REFERENCIA	P.V.P.	Kg.
03620023128	FUTUR/ASYM-1x28W. H.F.	260,98 €	(3,3)
03620023154	FUTUR/ASYM-1x54W. H.F.	260,98 €	(3,3)
03620023135	FUTUR/ASYM-1x35W. H.F.	291,91 €	(4,2)
03620023149	FUTUR/ASYM-1x49W. H.F.	291,91 €	(4,2)
03620023180	FUTUR/ASYM-1x80W. H.F.	295,64 €	(4,2)
03620023228	FUTUR/ASYM-2x28W. H.F.	268,04 €	(3,6)
03620023254	FUTUR/ASYM-2x54W. H.F.	268,04 €	(3,6)
03620023235	FUTUR/ASYM-2x35W. H.F.	297,59 €	(4,5)
03620023249	FUTUR/ASYM-2x49W. H.F.	297,59 €	(4,5)
03620023280	FUTUR/ASYM-2x80W. H.F.	330,85 €	(4,5)

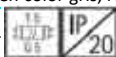

128/154/228/254W. - L=1250, Y=1200
135/149/180/235/249/280W. - L=1550, Y=1500

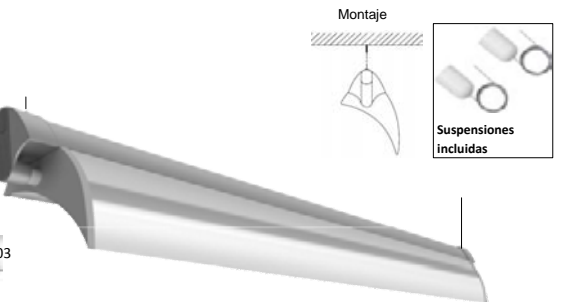
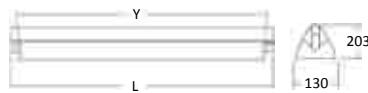

SUSPENDIDAS LINEAS CONTINUAS



Materiales: Cuerpo en aluminio extruido pintado en color gris, difusor brillante, con sistema de cable a través para una adecuada conexión en línea continua.

CODIGO	REFERENCIA	P.V.P.	Kg.
036200133128F	FUTUR/BR/LINEA-F-1x28W. H.F.	310,40 €	(3,3)
036200133128T	FUTUR/BR/LINEA-T-1x28W. H.F.	296,85 €	(3,3)
036200133128U	FUTUR/BR/LINEA-L-1x28W. H.F.	265,57 €	(3,3)
036200133154F	FUTUR/BR/LINEA-F-1x54W. H.F.	310,40 €	(3,3)
036200133154T	FUTUR/BR/LINEA-T-1x54W. H.F.	296,85 €	(3,3)
036200133154U	FUTUR/BR/LINEA-L-1x54W. H.F.	265,57 €	(3,3)
036200133135F	FUTUR/BR/LINEA-F-1x35W. H.F.	336,62 €	(4,2)
036200133135T	FUTUR/BR/LINEA-T-1x35W. H.F.	324,66 €	(4,2)
036200133135U	FUTUR/BR/LINEA-L-1x35W. H.F.	302,79 €	(4,2)
036200133149F	FUTUR/BR/LINEA-F-1x49W. H.F.	336,62 €	(4,2)
036200133149T	FUTUR/BR/LINEA-T-1x49W. H.F.	324,66 €	(4,2)
036200133149U	FUTUR/BR/LINEA-L-1x49W. H.F.	302,79 €	(4,2)
036200133180F	FUTUR/BR/LINEA-F-1x80W. H.F.	357,03 €	(4,2)
036200133180T	FUTUR/BR/LINEA-T-1x80W. H.F.	344,38 €	(4,2)
036200133180U	FUTUR/BR/LINEA-L-1x80W. H.F.	320,29 €	(4,2)
036200133228F	FUTUR/BR/LINEA-F-2x28W. H.F.	319,28 €	(3,6)
036200133228T	FUTUR/BR/LINEA-T-2x28W. H.F.	302,87 €	(3,6)
036200133228U	FUTUR/BR/LINEA-L-2x28W. H.F.	276,20 €	(3,6)
036200133254F	FUTUR/BR/LINEA-F-2x54W. H.F.	319,28 €	(3,6)
036200133254T	FUTUR/BR/LINEA-T-2x54W. H.F.	302,87 €	(3,6)
036200133254U	FUTUR/BR/LINEA-L-2x54W. H.F.	276,20 €	(3,6)
036200133235F	FUTUR/BR/LINEA-F-2x35W. H.F.	334,38 €	(4,5)
036200133235T	FUTUR/BR/LINEA-T-2x35W. H.F.	332,68 €	(4,5)
036200133235U	FUTUR/BR/LINEA-L-2x35W. H.F.	310,94 €	(4,5)
036200133249F	FUTUR/BR/LINEA-F-2x49W. H.F.	334,38 €	(4,5)
036200133249T	FUTUR/BR/LINEA-T-2x49W. H.F.	332,68 €	(4,5)
036200133249U	FUTUR/BR/LINEA-L-2x49W. H.F.	310,94 €	(4,5)



F=Primera
128/154/228/254W. - L=1285, Y=1225
135/149/180/235/249W. - L=1585, Y=1525

T=Media
128/154/228/254W. - L=1285, Y=1250
135/149/180/235/249W. - L=1585, Y=1550

L=Final
128/154/228/254W. - L=1250, Y=1225
135/149/180/235/249W. - L=1550, Y=1525

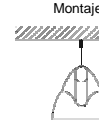
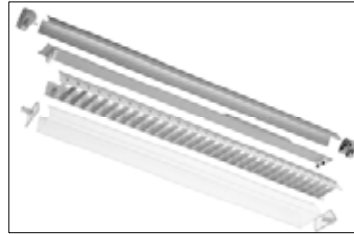

Montaje



Suspensiones incluidas

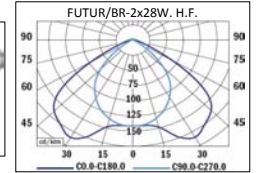

LOR = 45.31%

F=Primera

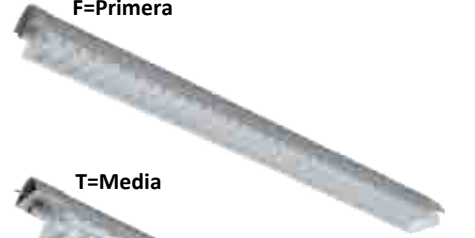

T=Media



L=Final



Materiales: Cuerpo en aluminio extruido pintado en color gris, difusor mate, con sistema de cable a través para una adecuada conexión en línea continua.

CODIGO	REFERENCIA	P.V.P.	Kg.
036200143128F	FUTUR/MR/LINEA-F-1x28W. H.F.	311,18 €	(3,3)
036200143128T	FUTUR/MR/LINEA-T-1x28W. H.F.	297,63 €	(3,3)
036200143128U	FUTUR/MR/LINEA-L-1x28W. H.F.	268,44 €	(3,3)
036200143154F	FUTUR/MR/LINEA-F-1x54W. H.F.	311,18 €	(3,3)
036200143154T	FUTUR/MR/LINEA-T-1x54W. H.F.	297,63 €	(3,3)
036200143154U	FUTUR/MR/LINEA-L-1x54W. H.F.	268,44 €	(3,3)
036200143135F	FUTUR/MR/LINEA-F-1x35W. H.F.	342,17 €	(4,2)
036200143135T	FUTUR/MR/LINEA-T-1x35W. H.F.	325,66 €	(4,2)
036200143135U	FUTUR/MR/LINEA-L-1x35W. H.F.	303,92 €	(4,2)
036200143149F	FUTUR/MR/LINEA-F-1x49W. H.F.	342,17 €	(4,2)
036200143149T	FUTUR/MR/LINEA-T-1x49W. H.F.	325,66 €	(4,2)
036200143149U	FUTUR/MR/LINEA-L-1x49W. H.F.	303,92 €	(4,2)
036200143180F	FUTUR/MR/LINEA-F-1x80W. H.F.	358,15 €	(4,2)
036200143180T	FUTUR/MR/LINEA-T-1x80W. H.F.	345,50 €	(4,2)
036200143180U	FUTUR/MR/LINEA-L-1x80W. H.F.	323,76 €	(4,2)
036200143228F	FUTUR/MR/LINEA-F-2x28W. H.F.	317,21 €	(3,6)
036200143228T	FUTUR/MR/LINEA-T-2x28W. H.F.	303,65 €	(3,6)
036200143228U	FUTUR/MR/LINEA-L-2x28W. H.F.	276,32 €	(3,6)
036200143254F	FUTUR/MR/LINEA-F-2x54W. H.F.	317,21 €	(3,6)
036200143254T	FUTUR/MR/LINEA-T-2x54W. H.F.	303,65 €	(3,6)
036200143254U	FUTUR/MR/LINEA-L-2x54W. H.F.	276,32 €	(3,6)
036200143235F	FUTUR/MR/LINEA-F-2x35W. H.F.	345,42 €	(4,5)
036200143235T	FUTUR/MR/LINEA-T-2x35W. H.F.	333,81 €	(4,5)
036200143235U	FUTUR/MR/LINEA-L-2x35W. H.F.	316,26 €	(4,5)
036200143249F	FUTUR/MR/LINEA-F-2x49W. H.F.	345,42 €	(4,5)
036200143249T	FUTUR/MR/LINEA-T-2x49W. H.F.	333,81 €	(4,5)
036200143249U	FUTUR/MR/LINEA-L-2x49W. H.F.	316,26 €	(4,5)



F=Primera
128/154/228/254W. - L=1285, Y=1225
135/149/180/235/249W. - L=1585, Y=1525

T=Media
128/154/228/254W. - L=1285, Y=1250
135/149/180/235/249W. - L=1585, Y=1550

L=Final
128/154/228/254W. - L=1250, Y=1225
135/149/180/235/249W. - L=1550, Y=1525

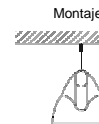
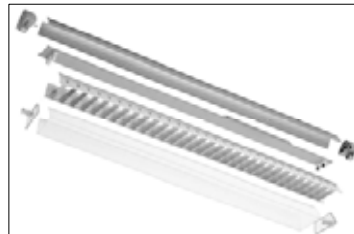

Montaje



Suspensiones incluidas

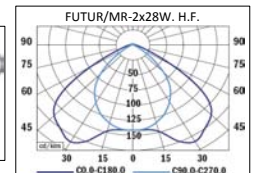

LOR = 41.96%

F=Primera

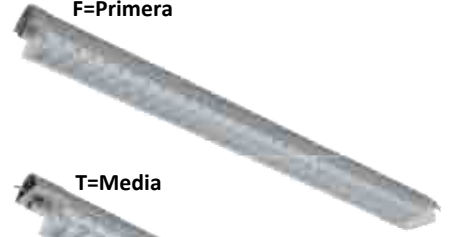

T=Media

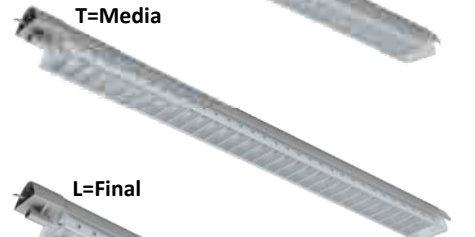

L=Final

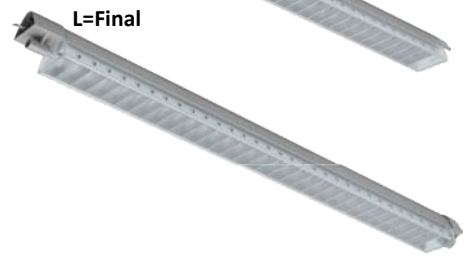

SUSPENDIDAS LINEAS CONTINUAS



Materiales: Cuerpo en aluminio extruido pintado en color gris, difusor opal, con sistema de cable a través para una adecuada conexión en línea continua.

CODIGO	REFERENCIA	P.V.P.	Kg.
036200163128F	FUTUR/OPAL/LINEA-F-1x28W. H.F.	292,47 €	(3,3)
036200163128T	FUTUR/OPAL/LINEA-T-1x28W. H.F.	278,95 €	(3,3)
036200163128U	FUTUR/OPAL/LINEA-L-1x28W. H.F.	247,59 €	(3,3)
036200163154F	FUTUR/OPAL/LINEA-F-1x54W. H.F.	292,47 €	(3,3)
036200163154T	FUTUR/OPAL/LINEA-T-1x54W. H.F.	278,95 €	(3,3)
036200163154U	FUTUR/OPAL/LINEA-L-1x54W. H.F.	247,59 €	(3,3)
036200163135F	FUTUR/OPAL/LINEA-F-1x35W. H.F.	314,44 €	(4,2)
036200163135T	FUTUR/OPAL/LINEA-T-1x35W. H.F.	300,96 €	(4,2)
036200163135U	FUTUR/OPAL/LINEA-L-1x35W. H.F.	278,23 €	(4,2)
036200163149F	FUTUR/OPAL/LINEA-F-1x49W. H.F.	314,44 €	(4,2)
036200163149T	FUTUR/OPAL/LINEA-T-1x49W. H.F.	300,96 €	(4,2)
036200163149U	FUTUR/OPAL/LINEA-L-1x49W. H.F.	278,23 €	(4,2)
036200163180F	FUTUR/OPAL/LINEA-F-1x80W. H.F.	322,37 €	(4,2)
036200163180T	FUTUR/OPAL/LINEA-T-1x80W. H.F.	303,70 €	(4,2)
036200163180U	FUTUR/OPAL/LINEA-L-1x80W. H.F.	296,16 €	(4,2)
036200163228F	FUTUR/OPAL/LINEA-F-2x28W. H.F.	298,49 €	(3,6)
036200163228T	FUTUR/OPAL/LINEA-T-2x28W. H.F.	286,72 €	(3,6)
036200163228U	FUTUR/OPAL/LINEA-L-2x28W. H.F.	254,02 €	(3,6)
036200163254F	FUTUR/OPAL/LINEA-F-2x54W. H.F.	298,49 €	(3,6)
036200163254T	FUTUR/OPAL/LINEA-T-2x54W. H.F.	286,72 €	(3,6)
036200163254U	FUTUR/OPAL/LINEA-L-2x54W. H.F.	254,02 €	(3,6)
036200163235F	FUTUR/OPAL/LINEA-F-2x35W. H.F.	324,41 €	(4,5)
036200163235T	FUTUR/OPAL/LINEA-T-2x35W. H.F.	321,59 €	(4,5)
036200163235U	FUTUR/OPAL/LINEA-L-2x35W. H.F.	283,95 €	(4,5)
036200163249F	FUTUR/OPAL/LINEA-F-2x49W. H.F.	324,41 €	(4,5)
036200163249T	FUTUR/OPAL/LINEA-T-2x49W. H.F.	321,59 €	(4,5)
036200163249U	FUTUR/OPAL/LINEA-L-2x49W. H.F.	283,95 €	(4,5)

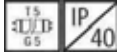

F=Primera
128/154/228/254W. - L=1285, Y=1225
135/149/180/235/249W. - L=1585, Y=1525

T=Media
128/154/228/254W. - L=1285, Y=1250
135/149/180/235/249W. - L=1585, Y=1550

L=Final
128/154/228/254W. - L=1250, Y=1225
135/149/180/235/249W. - L=1550, Y=1525

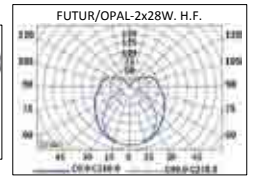
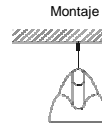
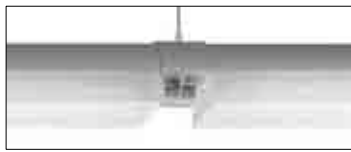

LOR = 72.81%

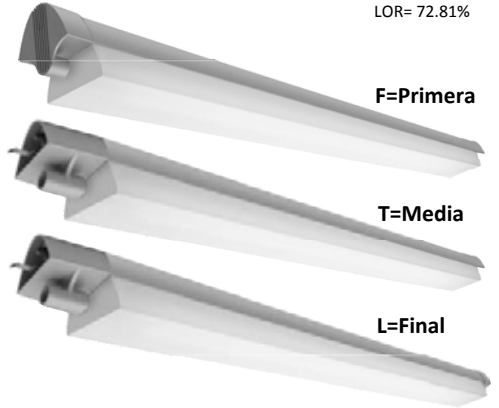

Materiales: Cuerpo en aluminio extruido pintado en color gris, reflector simétrico, con sistema de cable a través para una adecuada conexión en línea continua.

CODIGO	REFERENCIA	P.V.P.	Kg.
036200113128F	FUTUR/SYM/LINEA-F-1x28W. H.F.	288,54 €	(3,3)
036200113128T	FUTUR/SYM/LINEA-T-1x28W. H.F.	271,13 €	(3,3)
036200113128U	FUTUR/SYM/LINEA-L-1x28W. H.F.	255,53 €	(3,3)
036200113154F	FUTUR/SYM/LINEA-F-1x54W. H.F.	288,54 €	(3,3)
036200113154T	FUTUR/SYM/LINEA-T-1x54W. H.F.	271,13 €	(3,3)
036200113154U	FUTUR/SYM/LINEA-L-1x54W. H.F.	255,53 €	(3,3)
036200113135F	FUTUR/SYM/LINEA-F-1x35W. H.F.	325,27 €	(4,2)
036200113135T	FUTUR/SYM/LINEA-T-1x35W. H.F.	309,51 €	(4,2)
036200113135U	FUTUR/SYM/LINEA-L-1x35W. H.F.	290,88 €	(4,2)
036200113149F	FUTUR/SYM/LINEA-F-1x49W. H.F.	325,27 €	(4,2)
036200113149T	FUTUR/SYM/LINEA-T-1x49W. H.F.	309,51 €	(4,2)
036200113149U	FUTUR/SYM/LINEA-L-1x49W. H.F.	290,88 €	(4,2)
036200113180F	FUTUR/SYM/LINEA-F-1x80W. H.F.	345,11 €	(4,2)
036200113180T	FUTUR/SYM/LINEA-T-1x80W. H.F.	329,35 €	(4,2)
036200113180U	FUTUR/SYM/LINEA-L-1x80W. H.F.	310,72 €	(4,2)
036200113228F	FUTUR/SYM/LINEA-F-2x28W. H.F.	295,69 €	(3,6)
036200113228T	FUTUR/SYM/LINEA-T-2x28W. H.F.	278,19 €	(3,6)
036200113228U	FUTUR/SYM/LINEA-L-2x28W. H.F.	263,42 €	(3,6)
036200113254F	FUTUR/SYM/LINEA-F-2x54W. H.F.	295,69 €	(3,6)
036200113254T	FUTUR/SYM/LINEA-T-2x54W. H.F.	278,19 €	(3,6)
036200113254U	FUTUR/SYM/LINEA-L-2x54W. H.F.	263,42 €	(3,6)
036200113235F	FUTUR/SYM/LINEA-F-2x35W. H.F.	332,38 €	(4,5)
036200113235T	FUTUR/SYM/LINEA-T-2x35W. H.F.	317,65 €	(4,5)
036200113235U	FUTUR/SYM/LINEA-L-2x35W. H.F.	299,02 €	(4,5)
036200113249F	FUTUR/SYM/LINEA-F-2x49W. H.F.	332,38 €	(4,5)
036200113249T	FUTUR/SYM/LINEA-T-2x49W. H.F.	317,65 €	(4,5)
036200113249U	FUTUR/SYM/LINEA-L-2x49W. H.F.	299,02 €	(4,5)
036200113280F	FUTUR/SYM/LINEA-F-2x80W. H.F.	376,61 €	(4,5)
036200113280T	FUTUR/SYM/LINEA-T-2x80W. H.F.	362,27 €	(4,5)
036200113280U	FUTUR/SYM/LINEA-L-2x80W. H.F.	343,99 €	(4,5)



F=Primera
128/154/228/254W. - L=1285, Y=1225
135/149/180/235/249/280W. - L=1585, Y=1525

T=Media
128/154/228/254W. - L=1285, Y=1250
135/149/180/235/249/280W. - L=1585, Y=1550

L=Final
128/154/228/254W. - L=1250, Y=1225
135/149/180/235/249/280W. - L=1550, Y=1525

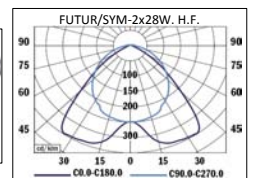
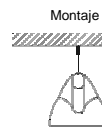
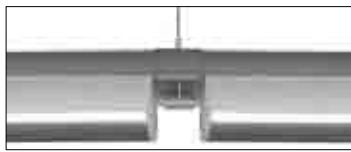

LOR = 83.49%

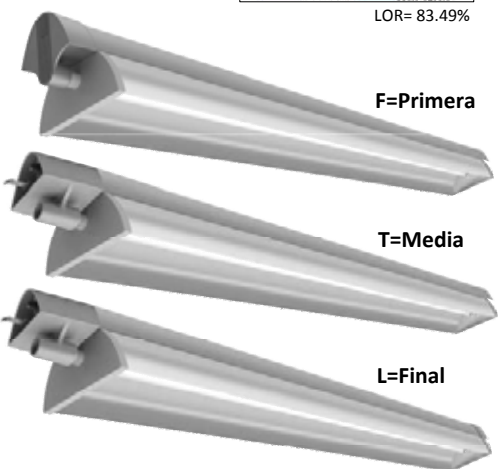

Materiales: Cuerpo en aluminio extruido pintado en color gris, reflector asimétrico, con sistema de cable a través para una adecuada conexión en línea continua.

CODIGO	REFERENCIA	P.V.P.	Kg.
036200123128F	FUTUR/ASYM/LINEA-F-1x28W. H.F.	327,28 €	(3,3)
036200123128T	FUTUR/ASYM/LINEA-T-1x28W. H.F.	304,45 €	(3,3)
036200123128U	FUTUR/ASYM/LINEA-L-1x28W. H.F.	288,98 €	(3,3)
036200123154F	FUTUR/ASYM/LINEA-F-1x54W. H.F.	327,28 €	(3,3)
036200123154T	FUTUR/ASYM/LINEA-T-1x54W. H.F.	304,45 €	(3,3)
036200123154U	FUTUR/ASYM/LINEA-L-1x54W. H.F.	288,98 €	(3,3)
036200123135F	FUTUR/ASYM/LINEA-F-1x35W. H.F.	336,02 €	(4,2)
036200123135T	FUTUR/ASYM/LINEA-T-1x35W. H.F.	327,96 €	(4,2)
036200123135U	FUTUR/ASYM/LINEA-L-1x35W. H.F.	307,38 €	(4,2)
036200123149F	FUTUR/ASYM/LINEA-F-1x49W. H.F.	336,02 €	(4,2)
036200123149T	FUTUR/ASYM/LINEA-T-1x49W. H.F.	327,96 €	(4,2)
036200123149U	FUTUR/ASYM/LINEA-L-1x49W. H.F.	307,38 €	(4,2)
036200123180F	FUTUR/ASYM/LINEA-F-1x80W. H.F.	365,26 €	(4,2)
036200123180T	FUTUR/ASYM/LINEA-T-1x80W. H.F.	347,84 €	(4,2)
036200123180U	FUTUR/ASYM/LINEA-L-1x80W. H.F.	327,40 €	(4,2)
036200123228F	FUTUR/ASYM/LINEA-F-2x28W. H.F.	336,03 €	(3,6)
036200123228T	FUTUR/ASYM/LINEA-T-2x28W. H.F.	313,20 €	(3,6)
036200123228U	FUTUR/ASYM/LINEA-L-2x28W. H.F.	297,73 €	(3,6)
036200123254F	FUTUR/ASYM/LINEA-F-2x54W. H.F.	336,03 €	(3,6)
036200123254T	FUTUR/ASYM/LINEA-T-2x54W. H.F.	313,20 €	(3,6)
036200123254U	FUTUR/ASYM/LINEA-L-2x54W. H.F.	297,73 €	(3,6)
036200123235F	FUTUR/ASYM/LINEA-F-2x35W. H.F.	360,21 €	(4,5)
036200123235T	FUTUR/ASYM/LINEA-T-2x35W. H.F.	337,84 €	(4,5)
036200123235U	FUTUR/ASYM/LINEA-L-2x35W. H.F.	321,92 €	(4,5)
036200123249F	FUTUR/ASYM/LINEA-F-2x49W. H.F.	360,21 €	(4,5)
036200123249T	FUTUR/ASYM/LINEA-T-2x49W. H.F.	337,84 €	(4,5)
036200123249U	FUTUR/ASYM/LINEA-L-2x49W. H.F.	321,92 €	(4,5)
036200123280F	FUTUR/ASYM/LINEA-F-2x80W. H.F.	406,57 €	(4,5)
036200123280T	FUTUR/ASYM/LINEA-T-2x80W. H.F.	383,74 €	(4,5)
036200123280U	FUTUR/ASYM/LINEA-L-2x80W. H.F.	368,27 €	(4,5)

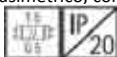

F=Primera
128/154/228/254W. - L=1285, Y=1225
135/149/180/235/249/280W. - L=1585, Y=1525

T=Media
128/154/228/254W. - L=1285, Y=1250
135/149/180/235/249/280W. - L=1585, Y=1550

L=Final
128/154/228/254W. - L=1250, Y=1225
135/149/180/235/249/280W. - L=1550, Y=1525

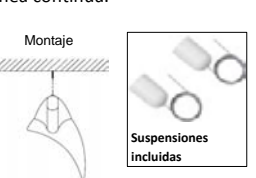
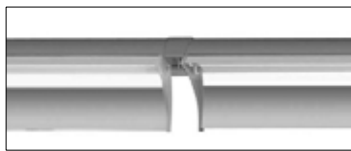

LOR = 83.49%

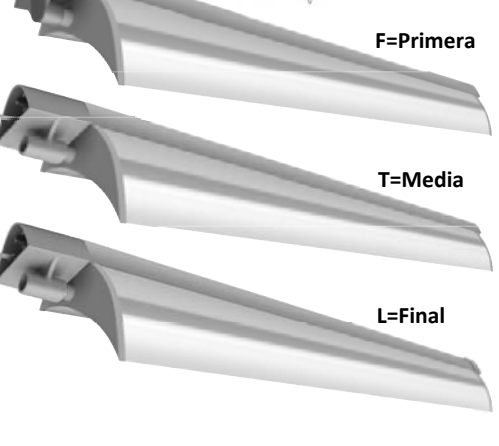

SUSPENDIDAS LINEAS CONTINUAS



Materiales: Cuerpo en aluminio extruido en color natural, reflector brillante, con sistema de cable a través para una adecuada conexión en línea continua.

CODIGO	REFERENCIA	P.V.P.	Kg.
15620325128F	T5-L/LINEA-F-1x28W. H.F.	260,51 €	(3,2)
15620325128T	T5-L/LINEA-T-1x28W. H.F.	253,45 €	(3,2)
15620325128U	T5-L/LINEA-L-1x28W. H.F.	239,98 €	(3,2)
15620325154F	T5-L/LINEA-F-1x54W. H.F.	260,51 €	(3,2)
15620325154T	T5-L/LINEA-T-1x54W. H.F.	253,45 €	(3,2)
15620325154U	T5-L/LINEA-L-1x54W. H.F.	239,98 €	(3,2)
15620325135F	T5-L/LINEA-F-1x35W. H.F.	344,90 €	(4,1)
15620325135T	T5-L/LINEA-T-1x35W. H.F.	297,46 €	(4,1)
15620325135U	T5-L/LINEA-L-1x35W. H.F.	280,96 €	(4,1)
15620325149F	T5-L/LINEA-F-1x49W. H.F.	344,90 €	(4,1)
15620325149T	T5-L/LINEA-T-1x49W. H.F.	297,46 €	(4,1)
15620325149U	T5-L/LINEA-L-1x49W. H.F.	280,96 €	(4,1)
15620325180F	T5-L/LINEA-F-1x80W. H.F.	320,47 €	(4,1)
15620325180T	T5-L/LINEA-T-1x80W. H.F.	304,61 €	(4,1)
15620325180U	T5-L/LINEA-L-1x80W. H.F.	299,37 €	(4,1)
15620325228F	T5-L/LINEA-F-2x28W. H.F.	327,53 €	(3,7)
15620325228T	T5-L/LINEA-T-2x28W. H.F.	303,62 €	(3,7)
15620325228U	T5-L/LINEA-L-2x28W. H.F.	304,01 €	(3,7)
15620325254F	T5-L/LINEA-F-2x54W. H.F.	327,53 €	(3,7)
15620325254T	T5-L/LINEA-T-2x54W. H.F.	303,62 €	(3,7)
15620325254U	T5-L/LINEA-L-2x54W. H.F.	304,01 €	(3,7)
15620325235F	T5-L/LINEA-F-2x35W. H.F.	371,71 €	(4,6)
15620325235T	T5-L/LINEA-T-2x35W. H.F.	353,91 €	(4,6)
15620325235U	T5-L/LINEA-L-2x35W. H.F.	352,42 €	(4,6)
15620325249F	T5-L/LINEA-F-2x49W. H.F.	371,71 €	(4,6)
15620325249T	T5-L/LINEA-T-2x49W. H.F.	353,91 €	(4,6)
15620325249U	T5-L/LINEA-L-2x49W. H.F.	352,42 €	(4,6)
15620325280F	T5-L/LINEA-F-2x80W. H.F.	413,47 €	(4,6)
15620325280T	T5-L/LINEA-T-2x80W. H.F.	395,67 €	(4,6)
15620325280U	T5-L/LINEA-L-2x80W. H.F.	394,18 €	(4,6)

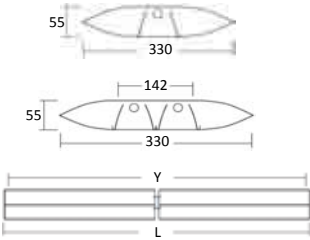

F=Primera
128/154/228/254W. - L=1188, Y=1173
135/149/180/235/249/280W. - L=1488, Y=1473

T=Media
128/154/228/254W. - L=1188, Y=1188
135/149/180/235/249/280W. - L=1488, Y=1488

L=Final
128/154/228/254W. - L=1188, Y=1173
135/149/180/235/249/280W. - L=1488, Y=1473



Montaje



Suspensiones incluidas

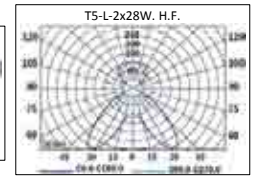

LOR = 87.89%

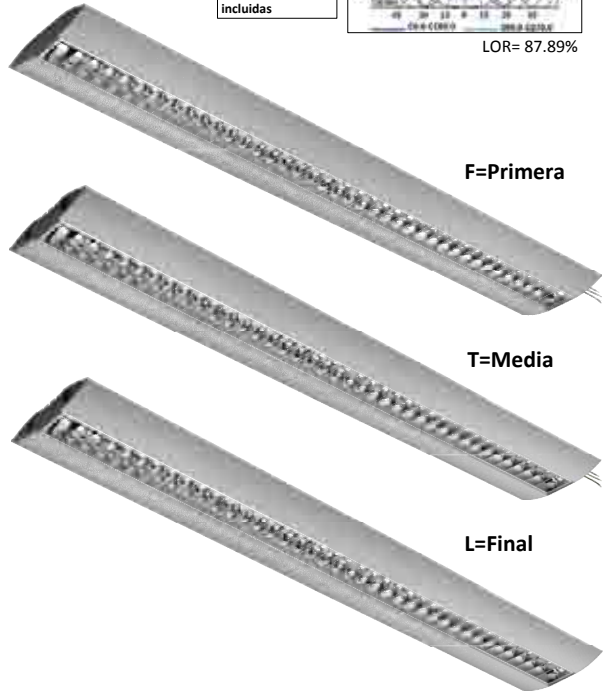

Materiales: Cuerpo en aluminio extruido en color natural, difusor microprisma, con sistema de cable a través para una adecuada conexión en línea continua.

CODIGO	REFERENCIA	P.V.P.	Kg.
15620335228F	T5-L/MICROPRISMA-CONICO/LINEA-F-2x28W. H.F.	382,42 €	(3,7)
15620335228T	T5-L/MICROPRISMA-CONICO/LINEA-T-2x28W. H.F.	367,30 €	(3,7)
15620335228U	T5-L/MICROPRISMA-CONICO/LINEA-L-2x28W. H.F.	351,79 €	(3,7)
15620335254F	T5-L/MICROPRISMA-CONICO/LINEA-F-2x54W. H.F.	382,42 €	(3,7)
15620335254T	T5-L/MICROPRISMA-CONICO/LINEA-T-2x54W. H.F.	367,30 €	(3,7)
15620335254U	T5-L/MICROPRISMA-CONICO/LINEA-L-2x54W. H.F.	351,79 €	(3,7)
15620335235F	T5-L/MICROPRISMA-CONICO/LINEA-F-2x35W. H.F.	449,69 €	(4,6)
15620335235T	T5-L/MICROPRISMA-CONICO/LINEA-T-2x35W. H.F.	434,53 €	(4,6)
15620335235U	T5-L/MICROPRISMA-CONICO/LINEA-L-2x35W. H.F.	418,80 €	(4,6)
15620335249F	T5-L/MICROPRISMA-CONICO/LINEA-F-2x49W. H.F.	449,69 €	(4,6)
15620335249T	T5-L/MICROPRISMA-CONICO/LINEA-T-2x49W. H.F.	434,53 €	(4,6)
15620335249U	T5-L/MICROPRISMA-CONICO/LINEA-L-2x49W. H.F.	418,80 €	(4,6)
15620335280F	T5-L/MICROPRISMA-CONICO/LINEA-F-2x80W. H.F.	491,41 €	(4,6)
15620335280T	T5-L/MICROPRISMA-CONICO/LINEA-T-2x80W. H.F.	477,01 €	(4,6)
15620335280U	T5-L/MICROPRISMA-CONICO/LINEA-L-2x80W. H.F.	461,28 €	(4,6)
15620345228F	T5-L/MICROPRISMA-LINEAL/LINEA-F-2x28W. H.F.	513,59 €	(3,7)
15620345228T	T5-L/MICROPRISMA-LINEAL/LINEA-T-2x28W. H.F.	498,25 €	(3,7)
15620345228U	T5-L/MICROPRISMA-LINEAL/LINEA-L-2x28W. H.F.	497,48 €	(3,7)
15620345254F	T5-L/MICROPRISMA-LINEAL/LINEA-F-2x54W. H.F.	513,59 €	(3,7)
15620345254T	T5-L/MICROPRISMA-LINEAL/LINEA-T-2x54W. H.F.	498,25 €	(3,7)
15620345254U	T5-L/MICROPRISMA-LINEAL/LINEA-L-2x54W. H.F.	497,48 €	(3,7)
15620345235F	T5-L/MICROPRISMA-LINEAL/LINEA-F-2x35W. H.F.	573,74 €	(4,6)
15620345235T	T5-L/MICROPRISMA-LINEAL/LINEA-T-2x35W. H.F.	573,74 €	(4,6)
15620345235U	T5-L/MICROPRISMA-LINEAL/LINEA-L-2x35W. H.F.	572,97 €	(4,6)
15620345249F	T5-L/MICROPRISMA-LINEAL/LINEA-F-2x49W. H.F.	573,74 €	(4,6)
15620345249T	T5-L/MICROPRISMA-LINEAL/LINEA-T-2x49W. H.F.	573,74 €	(4,6)
15620345249U	T5-L/MICROPRISMA-LINEAL/LINEA-L-2x49W. H.F.	572,97 €	(4,6)
15620345280F	T5-L/MICROPRISMA-LINEAL/LINEA-F-2x80W. H.F.	617,71 €	(4,6)
15620345280T	T5-L/MICROPRISMA-LINEAL/LINEA-T-2x80W. H.F.	617,71 €	(4,6)
15620345280U	T5-L/MICROPRISMA-LINEAL/LINEA-L-2x80W. H.F.	616,94 €	(4,6)



Microprisma-Cónico (CDP)

Montaje

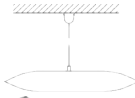

Suspensiones incluidas

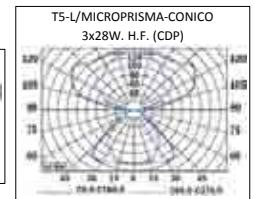

LOR = 86.36%

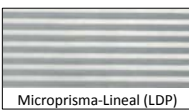

Microprisma-Lineal (LDP)

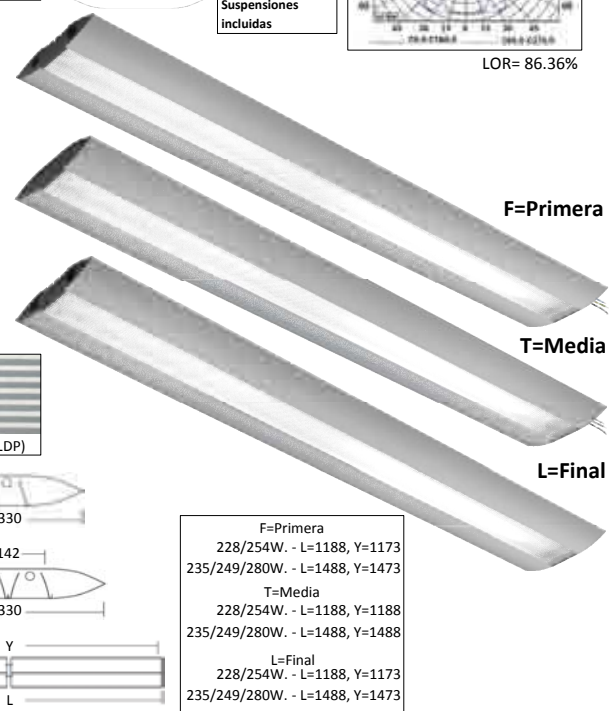
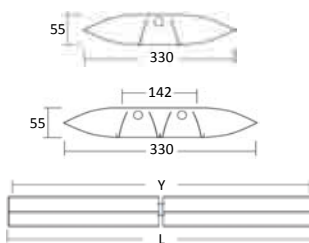

F=Primera
228/254W. - L=1188, Y=1173
235/249/280W. - L=1488, Y=1473

T=Media
228/254W. - L=1188, Y=1188
235/249/280W. - L=1488, Y=1488

L=Final
228/254W. - L=1188, Y=1173
235/249/280W. - L=1488, Y=1473

SUSPENDIDAS LINEAS CONTINUAS



Materiales: Cuerpo en chapa de acero, reflector brillante, con sistema de cable a través para una adecuada conexión en línea continua.

CODIGO	REFERENCIA	P.V.P.	Kg.
15620425128F	EVOLUTION/LINEA-F-1x28W. H.F. (DIRECTA/INDIRECTA)	236,69 €	(3,3)
15620425128T	EVOLUTION/LINEA-T-1x28W. H.F. (DIRECTA/INDIRECTA)	235,30 €	(3,2)
15620425128U	EVOLUTION/LINEA-L-1x28W. H.F. (DIRECTA/INDIRECTA)	227,34 €	(3,2)
15620425154F	EVOLUTION/LINEA-F-1x54W. H.F. (DIRECTA/INDIRECTA)	236,69 €	(3,3)
15620425154T	EVOLUTION/LINEA-T-1x54W. H.F. (DIRECTA/INDIRECTA)	235,30 €	(3,2)
15620425154U	EVOLUTION/LINEA-L-1x54W. H.F. (DIRECTA/INDIRECTA)	227,34 €	(3,2)
15620425135F	EVOLUTION/LINEA-F-1x35W. H.F. (DIRECTA/INDIRECTA)	259,73 €	(3,9)
15620425135T	EVOLUTION/LINEA-T-1x35W. H.F. (DIRECTA/INDIRECTA)	248,42 €	(3,7)
15620425135U	EVOLUTION/LINEA-L-1x35W. H.F. (DIRECTA/INDIRECTA)	238,05 €	(3,7)
15620425149F	EVOLUTION/LINEA-F-1x49W. H.F. (DIRECTA/INDIRECTA)	259,73 €	(3,9)
15620425149T	EVOLUTION/LINEA-T-1x49W. H.F. (DIRECTA/INDIRECTA)	248,42 €	(3,7)
15620425149U	EVOLUTION/LINEA-L-1x49W. H.F. (DIRECTA/INDIRECTA)	238,05 €	(3,7)
15620425180F	EVOLUTION/LINEA-F-1x80W. H.F. (DIRECTA/INDIRECTA)	279,53 €	(3,9)
15620425180T	EVOLUTION/LINEA-T-1x80W. H.F. (DIRECTA/INDIRECTA)	268,26 €	(3,7)
15620425180U	EVOLUTION/LINEA-L-1x80W. H.F. (DIRECTA/INDIRECTA)	255,79 €	(3,7)
15620425228F	EVOLUTION/LINEA-F-2x28W. H.F. (DIRECTA/INDIRECTA)	249,64 €	(3,5)
15620425228T	EVOLUTION/LINEA-T-2x28W. H.F. (DIRECTA/INDIRECTA)	243,45 €	(3,4)
15620425228U	EVOLUTION/LINEA-L-2x28W. H.F. (DIRECTA/INDIRECTA)	232,97 €	(3,4)
15620425254F	EVOLUTION/LINEA-F-2x54W. H.F. (DIRECTA/INDIRECTA)	249,64 €	(3,5)
15620425254T	EVOLUTION/LINEA-T-2x54W. H.F. (DIRECTA/INDIRECTA)	243,45 €	(3,4)
15620425254U	EVOLUTION/LINEA-L-2x54W. H.F. (DIRECTA/INDIRECTA)	232,97 €	(3,4)
15620425235F	EVOLUTION/LINEA-F-2x35W. H.F. (DIRECTA/INDIRECTA)	273,81 €	(4,1)
15620425235T	EVOLUTION/LINEA-T-2x35W. H.F. (DIRECTA/INDIRECTA)	261,90 €	(3,9)
15620425235U	EVOLUTION/LINEA-L-2x35W. H.F. (DIRECTA/INDIRECTA)	255,53 €	(3,9)
15620425249F	EVOLUTION/LINEA-F-2x49W. H.F. (DIRECTA/INDIRECTA)	273,81 €	(4,1)
15620425249T	EVOLUTION/LINEA-T-2x49W. H.F. (DIRECTA/INDIRECTA)	261,90 €	(3,9)
15620425249U	EVOLUTION/LINEA-L-2x49W. H.F. (DIRECTA/INDIRECTA)	255,53 €	(3,9)
15620425280F	EVOLUTION/LINEA-F-2x80W. H.F. (DIRECTA/INDIRECTA)	318,78 €	(4,1)
15620425280T	EVOLUTION/LINEA-T-2x80W. H.F. (DIRECTA/INDIRECTA)	306,78 €	(3,9)
15620425280U	EVOLUTION/LINEA-L-2x80W. H.F. (DIRECTA/INDIRECTA)	296,34 €	(3,9)
15620425128FG	EVOLUTION/GRIS/LINEA-F-1x28W. H.F. (DIRECTA/INDIRECTA)	254,88 €	(3,3)
15620425128TG	EVOLUTION/GRIS/LINEA-T-1x28W. H.F. (DIRECTA/INDIRECTA)	253,50 €	(3,2)
15620425128UG	EVOLUTION/GRIS/LINEA-L-1x28W. H.F. (DIRECTA/INDIRECTA)	245,53 €	(3,2)
15620425154FG	EVOLUTION/GRIS/LINEA-F-1x54W. H.F. (DIRECTA/INDIRECTA)	254,88 €	(3,3)
15620425154TG	EVOLUTION/GRIS/LINEA-T-1x54W. H.F. (DIRECTA/INDIRECTA)	253,50 €	(3,2)
15620425154UG	EVOLUTION/GRIS/LINEA-L-1x54W. H.F. (DIRECTA/INDIRECTA)	245,53 €	(3,2)
15620425135FG	EVOLUTION/GRIS/LINEA-F-1x35W. H.F. (DIRECTA/INDIRECTA)	277,93 €	(3,9)
15620425135TG	EVOLUTION/GRIS/LINEA-T-1x35W. H.F. (DIRECTA/INDIRECTA)	266,62 €	(3,7)
15620425135UG	EVOLUTION/GRIS/LINEA-L-1x35W. H.F. (DIRECTA/INDIRECTA)	256,25 €	(3,7)
15620425149FG	EVOLUTION/GRIS/LINEA-F-1x49W. H.F. (DIRECTA/INDIRECTA)	277,93 €	(3,9)
15620425149TG	EVOLUTION/GRIS/LINEA-T-1x49W. H.F. (DIRECTA/INDIRECTA)	266,62 €	(3,7)
15620425149UG	EVOLUTION/GRIS/LINEA-L-1x49W. H.F. (DIRECTA/INDIRECTA)	256,25 €	(3,7)
15620425180FG	EVOLUTION/GRIS/LINEA-F-1x80W. H.F. (DIRECTA/INDIRECTA)	297,72 €	(3,9)
15620425180TG	EVOLUTION/GRIS/LINEA-T-1x80W. H.F. (DIRECTA/INDIRECTA)	286,46 €	(3,7)
15620425180UG	EVOLUTION/GRIS/LINEA-L-1x80W. H.F. (DIRECTA/INDIRECTA)	273,98 €	(3,7)
15620425228FG	EVOLUTION/GRIS/LINEA-F-2x28W. H.F. (DIRECTA/INDIRECTA)	267,83 €	(3,5)
15620425228TG	EVOLUTION/GRIS/LINEA-T-2x28W. H.F. (DIRECTA/INDIRECTA)	261,64 €	(3,4)
15620425228UG	EVOLUTION/GRIS/LINEA-L-2x28W. H.F. (DIRECTA/INDIRECTA)	251,16 €	(3,4)
15620425254FG	EVOLUTION/GRIS/LINEA-F-2x54W. H.F. (DIRECTA/INDIRECTA)	267,83 €	(3,5)
15620425254TG	EVOLUTION/GRIS/LINEA-T-2x54W. H.F. (DIRECTA/INDIRECTA)	261,64 €	(3,4)
15620425254UG	EVOLUTION/GRIS/LINEA-L-2x54W. H.F. (DIRECTA/INDIRECTA)	251,16 €	(3,4)
15620425235FG	EVOLUTION/GRIS/LINEA-F-2x35W. H.F. (DIRECTA/INDIRECTA)	292,00 €	(4,1)
15620425235TG	EVOLUTION/GRIS/LINEA-T-2x35W. H.F. (DIRECTA/INDIRECTA)	280,09 €	(3,9)
15620425235UG	EVOLUTION/GRIS/LINEA-L-2x35W. H.F. (DIRECTA/INDIRECTA)	273,72 €	(3,9)
15620425249FG	EVOLUTION/GRIS/LINEA-F-2x49W. H.F. (DIRECTA/INDIRECTA)	292,00 €	(4,1)
15620425249TG	EVOLUTION/GRIS/LINEA-T-2x49W. H.F. (DIRECTA/INDIRECTA)	280,09 €	(3,9)
15620425249UG	EVOLUTION/GRIS/LINEA-L-2x49W. H.F. (DIRECTA/INDIRECTA)	273,72 €	(3,9)
15620425280FG	EVOLUTION/GRIS/LINEA-F-2x80W. H.F. (DIRECTA/INDIRECTA)	336,97 €	(4,1)
15620425280TG	EVOLUTION/GRIS/LINEA-T-2x80W. H.F. (DIRECTA/INDIRECTA)	324,97 €	(3,9)
15620425280UG	EVOLUTION/GRIS/LINEA-L-2x80W. H.F. (DIRECTA/INDIRECTA)	314,53 €	(3,9)

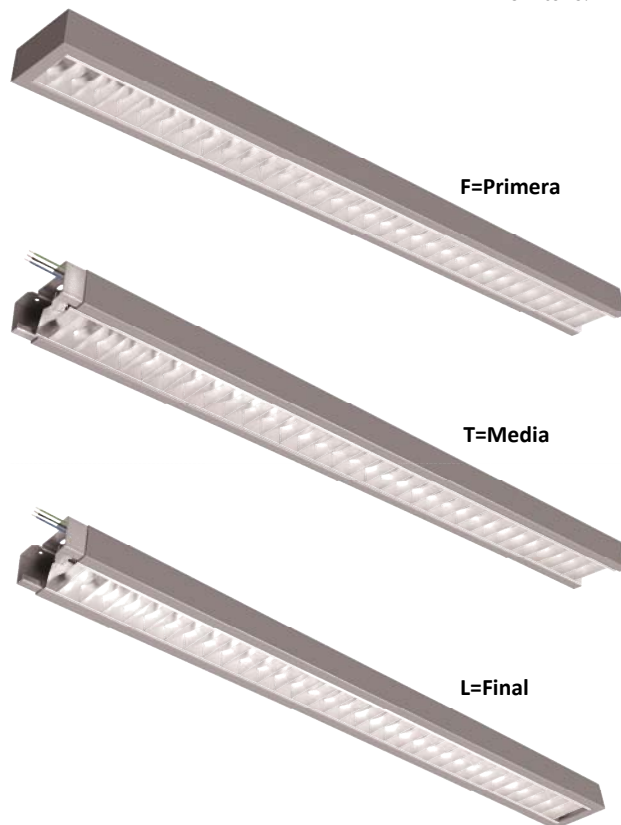
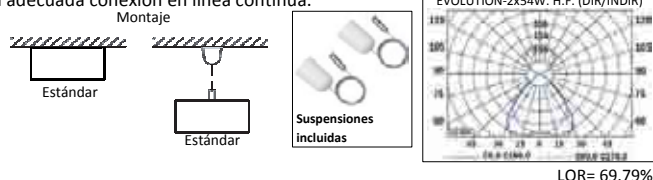

F=Primera	
128/154/228/254W.	- L=1187, Y=1134
135/149/180/235/249/280W.	- L=1487, Y=1434
T=Media	
128/154/228/254W.	- L=1168, Y=1168
135/149/180/235/249/280W.	- L=1468, Y=1468
L=Final	
128/154/228/254W.	- L=1187, Y=1134
135/149/180/235/249/280W.	- L=1487, Y=1434

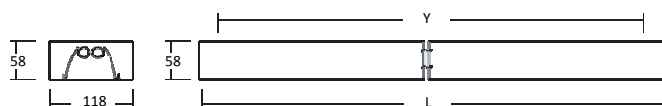

EVOLUTION/LINEA (DIRECTA), mismo precio.

SUSPENDIDAS SERIE CARRIL LINE STYLE



Materiales: Cuerpo en aluminio pintado en color estandar gris RAL9006, tapas laterales en ABS.

CODIGO	REFERENCIA	P.V.P.	Kg.
04112033128	LINE STYLE/T5-X-GRIS-1x28W. H.F. (DIRECTA)	273,32 €	(5,3)
04112033154	LINE STYLE/T5-X-GRIS-1x54W. H.F. (DIRECTA)	273,32 €	(5,3)
04112033135	LINE STYLE/T5-X-GRIS-1x35W. H.F. (DIRECTA)	292,73 €	(6,5)
04112033149	LINE STYLE/T5-X-GRIS-1x49W. H.F. (DIRECTA)	292,73 €	(6,5)
04112033180	LINE STYLE/T5-X-GRIS-1x80W. H.F. (DIRECTA)	304,34 €	(6,5)
04112033228	LINE STYLE/T5-X-GRIS-2x28W. H.F. (DIRECTA)	296,17 €	(5,3)
04112033254	LINE STYLE/T5-X-GRIS-2x54W. H.F. (DIRECTA)	296,17 €	(5,3)
04112033235	LINE STYLE/T5-X-GRIS-2x35W. H.F. (DIRECTA)	323,40 €	(6,5)
04112033249	LINE STYLE/T5-X-GRIS-2x49W. H.F. (DIRECTA)	323,40 €	(6,5)
04112033280	LINE STYLE/T5-X-GRIS-2x80W. H.F. (DIRECTA)	373,50 €	(6,5)

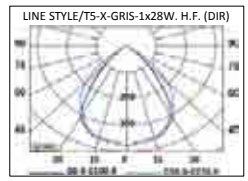
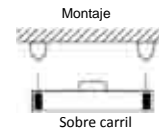
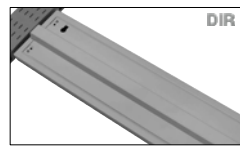

128/154/228/254W. - L=1362
135/149/180/235/249/280W. - L=1662

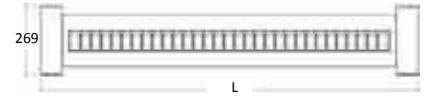

04112043128	LINE STYLE/T5-X-GRIS-1x28W. H.F. (DIRECTA/INDIRECTA)	274,28 €	(5,3)
04112043154	LINE STYLE/T5-X-GRIS-1x54W. H.F. (DIRECTA/INDIRECTA)	274,28 €	(5,3)
04112043135	LINE STYLE/T5-X-GRIS-1x35W. H.F. (DIRECTA/INDIRECTA)	298,10 €	(6,5)
04112043149	LINE STYLE/T5-X-GRIS-1x49W. H.F. (DIRECTA/INDIRECTA)	298,10 €	(6,5)
04112043180	LINE STYLE/T5-X-GRIS-1x80W. H.F. (DIRECTA/INDIRECTA)	309,82 €	(6,5)
04112043228	LINE STYLE/T5-X-GRIS-2x28W. H.F. (DIRECTA/INDIRECTA)	296,17 €	(5,3)
04112043254	LINE STYLE/T5-X-GRIS-2x54W. H.F. (DIRECTA/INDIRECTA)	296,17 €	(5,3)
04112043235	LINE STYLE/T5-X-GRIS-2x35W. H.F. (DIRECTA/INDIRECTA)	323,40 €	(6,5)
04112043249	LINE STYLE/T5-X-GRIS-2x49W. H.F. (DIRECTA/INDIRECTA)	323,40 €	(6,5)
04112043280	LINE STYLE/T5-X-GRIS-2x80W. H.F. (DIRECTA/INDIRECTA)	373,50 €	(6,5)

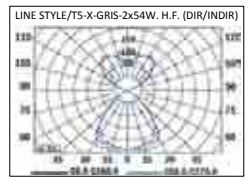

Incluido equipo electrónico, tubos no incluidos.

Materiales: Cuerpo en aluminio pintado en color estandar gris RAL9006, tapas laterales en ABS.

04112013135L	LINE STYLE-1x35W. H.F. + 1 QR-111	240,40 €	(2,4)
04112013150L	LINE STYLE-1x50W. H.F. + 1 QR-111	240,40 €	(2,4)
04112013175L	LINE STYLE-1x75W. H.F. + 1 QR-111	254,39 €	(2,4)
04112013100L	LINE STYLE-1x100W. H.F. + 1 QR-111	255,00 €	(2,4)

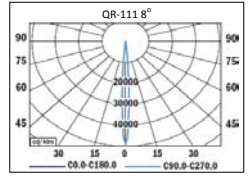
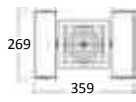
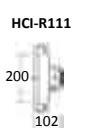

04112023120L	LINE STYLE-1x20W. H.F. + 1 HCI-R111	524,75 €	(2,4)
04112023135L	LINE STYLE-1x35W. H.F. + 1 HCI-R111	535,51 €	(2,4)

04112073121L	LINE STYLE-LED-R111-1x21W. (7x3) H.F. + LEDS	908,92 €	(2,3)
--------------	--	----------	-------

Incluidos equipo electrónico y lámpara.

04112013235L	LINE STYLE-2x35W. H.F. + 2 QR-111	391,98 €	(3,6)
04112013250L	LINE STYLE-2x50W. H.F. + 2 QR-111	391,98 €	(3,6)
04112013275L	LINE STYLE-2x75W. H.F. + 2 QR-111	423,51 €	(3,6)
04112013200L	LINE STYLE-2x100W. H.F. + 2 QR-111	541,47 €	(3,6)

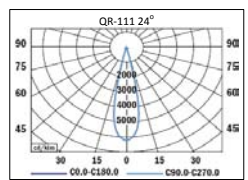
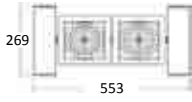
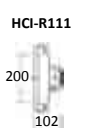

04112023220L	LINE STYLE-2x20W. H.F. + 2 HCI-R111	949,44 €	(3,6)
04112023235L	LINE STYLE-2x35W. H.F. + 2 HCI-R111	999,47 €	(3,6)

04112073221L	LINE STYLE-LED-R111-2x21W. (14x3) H.F. + LEDS	1.744,48 €	(3,4)
--------------	---	------------	-------

Incluidos equipo electrónico y lámparas.

04112013335L	LINE STYLE-3x35W. H.F. + 3 QR-111	563,91 €	(4,9)
04112013350L	LINE STYLE-3x50W. H.F. + 3 QR-111	563,91 €	(4,9)
04112013375L	LINE STYLE-3x75W. H.F. + 3 QR-111	678,54 €	(4,9)
04112013300L	LINE STYLE-3x100W. H.F. + 3 QR-111	687,63 €	(4,9)

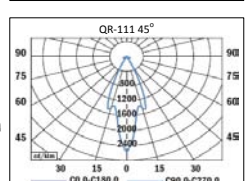
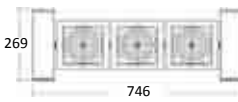

04112023320L	LINE STYLE-3x20W. H.F. + 3 HCI-R111	1.390,65 €	(4,9)
04112023335L	LINE STYLE-3x35W. H.F. + 3 HCI-R111	1.463,43 €	(4,9)

04112073321L	LINE STYLE-LED-R111-3x21W. (21x3) H.F. + LEDS	2.607,89 €	(5,0)
--------------	---	------------	-------

Incluidos equipo electrónico y lámparas.

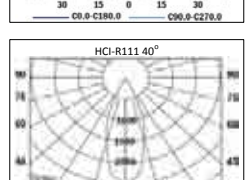
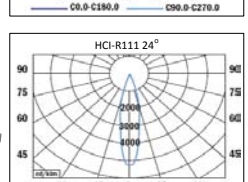
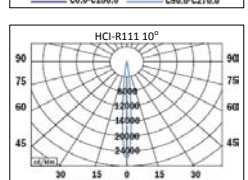

CARRILES Y ACCESORIOS LINE STYLE

04111001	CARRIL LINE STYLE 1,5 Mts. (2 Uds.)	103,40 €	-
04111002	CARRIL LINE STYLE 3 Mts. (2 Uds.)	194,37 €	-

04111006	TAPA FINAL CARRIL LINE STYLE (2 Uds.)	5,01 €	-
----------	--	---------------	---

04111007	PIEZA CONEXION CARRIL LINE STYLE (2 Uds.)	7,50 €	-
----------	--	---------------	---

04111009	UNION ANGULAR CARRIL LINE STYLE (2 Uds.)	40,29 €	-
----------	---	----------------	---

04111008	SUSPENSION CARRIL LINE STYLE (2 Uds.) (cada 2 m. de carril)	49,78 €	-
----------	---	----------------	---

04111003	CABLE 3 POLOS (5 metros) con conexión rápida	16,27 €	-
041110031	CABLE 3 POLOS (10 metros) con conexión rápida	32,04 €	-
041110032	CABLE 5 POLOS (5 metros) con conexión rápida	26,62 €	-
041110033	CABLE 5 POLOS (10 metros) con conexión rápida	52,74 €	-

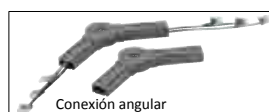

LUMINARIAS MULTIDIRECCIONALES SERIE STYLE/C

Materiales: Cuerpo en aluminio pintado en color estandar gris RAL 9006.

CODIGO	REFERENCIA	P.V.P.	Kg.
04112053335L	STYLE/C-3x35W. H.F. + 3 QR-111	656,36 €	(7,3)
04112053350L	STYLE/C-3x50W. H.F. + 3 QR-111	685,94 €	(7,3)
04112053375L	STYLE/C-3x75W. H.F. + 3 QR-111	789,61 €	(7,3)
04112053300L	STYLE/C-3x100W. H.F. + 3 QR-111	796,76 €	(7,3)
04112063320L	STYLE/C-3x20W. H.F. + 3 HCI-R111	1.602,52 €	(7,3)
04112063335L	STYLE/C-3x35W. H.F. + 3 HCI-R111	1.618,08 €	(7,3)
04112083321L	STYLE/C-LED-R111-3x21W. (21x3) H.F. + LEDS	2.827,21 €	(7,3)

Incluidos equipo electrónico y lámparas.

Suspensiones incluidas en el precio de la luminaria.

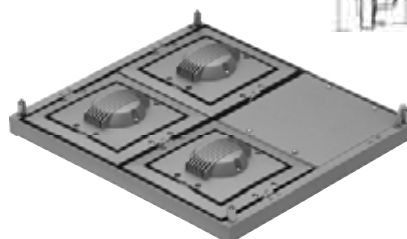
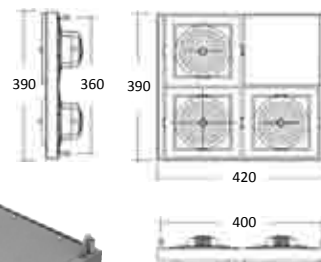
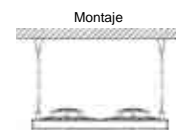
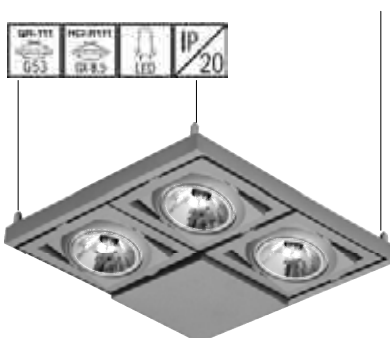
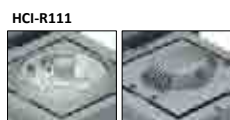

MULTIDIRECCIONALES ADOSABLES SERIE COMPACT

Materiales: Cuerpo en aluminio pintado en color estandar gris RAL 9006.

CODIGO	REFERENCIA	P.V.P.	Kg.
04112113135L	COMPACT-1 1x35W. H.F. + 1 QR-111	259,89 €	(2,8)
04112113150L	COMPACT-1 1x50W. H.F. + 1 QR-111	259,89 €	(2,8)
04112113175L	COMPACT-1 1x75W. H.F. + 1 QR-111	259,89 €	(2,8)
04112113100L	COMPACT-1 1x100W. H.F. + 1 QR-111	267,56 €	(2,8)
04112123120L	COMPACT-1 1x20W. H.F. + 1 HCI-R111	451,45 €	(2,1)
04112123135L	COMPACT-1 1x35W. H.F. + 1 HCI-R111	451,45 €	(2,1)
04112123170L	COMPACT-1 1x70W. H.F. + 1 HCI-R111	451,45 €	(2,1)

Incluidos equipo electrónico y lámparas.

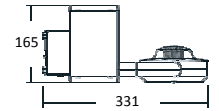

04112113235L	COMPACT-2 2x35W. H.F. + 2 QR-111	355,54 €	(3,0)
04112113250L	COMPACT-2 2x50W. H.F. + 2 QR-111	370,36 €	(3,0)
04112113275L	COMPACT-2 2x75W. H.F. + 2 QR-111	399,99 €	(3,0)
04112113200L	COMPACT-2 2x100W. H.F. + 2 QR-111	503,61 €	(3,0)

04112123220L	COMPACT-2 2x20W. H.F. + 2 HCI-R111	787,11 €	(2,3)
04112123235L	COMPACT-2 2x35W. H.F. + 2 HCI-R111	787,11 €	(2,3)

Incluidos equipo electrónico y lámparas.

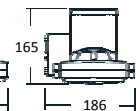
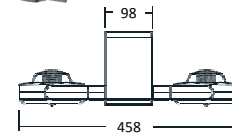
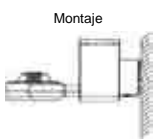

04112113335L	COMPACT-3 3x35W. H.F. + 3 QR-111	511,58 €	(3,9)
04112113350L	COMPACT-3 3x50W. H.F. + 3 QR-111	511,58 €	(3,9)
04112113375L	COMPACT-3 3x75W. H.F. + 3 QR-111	615,25 €	(3,9)
04112113300L	COMPACT-3 3x100W. H.F. + 3 QR-111	615,25 €	(3,9)

04112123320L	COMPACT-3 3x20W. H.F. + 3 HCI-R111	1.140,90 €	(3,2)
04112123335L	COMPACT-3 3x35W. H.F. + 3 HCI-R111	1.140,90 €	(3,2)

Incluidos equipo electrónico y lámparas.

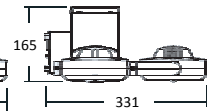
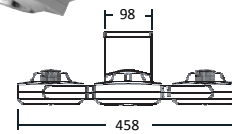
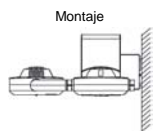
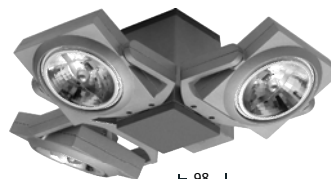

MULTIDIRECCIONALES SUSPENDIDOS SERIE COMPACT/SUS

Materiales: Cuerpo en aluminio pintado en color estandar gris RAL 9006.

04112213235L	COMPACT/SUS-2 2x35W. H.F. + 2 QR-111	405,58 €	(3,4)
04112213250L	COMPACT/SUS-2 2x50W. H.F. + 2 QR-111	405,58 €	(3,4)
04112213275L	COMPACT/SUS-2 2x75W. H.F. + 2 QR-111	436,64 €	(3,4)
04112213200L	COMPACT/SUS-2 2x100W. H.F. + 2 QR-111	512,10 €	(3,4)

04112223220L	COMPACT/SUS-2 2x20W. H.F. + 2 HCI-R111	812,72 €	(2,7)
04112223235L	COMPACT/SUS-2 2x35W. H.F. + 2 HCI-R111	890,19 €	(2,7)

Incluidos equipo electrónico y lámparas.

Suspensiones incluidas en el precio de la luminaria.

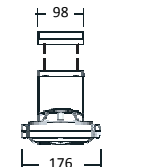
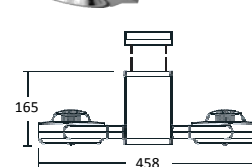
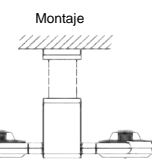

04112213435L	COMPACT/SUS-4 4x35W. H.F. + 3 QR-111	706,95 €	(5,2)
04112213450L	COMPACT/SUS-4 4x50W. H.F. + 3 QR-111	777,18 €	(5,2)
04112213475L	COMPACT/SUS-4 4x75W. H.F. + 3 QR-111	808,19 €	(5,2)
04112213400L	COMPACT/SUS-4 4x100W. H.F. + 3 QR-111	808,19 €	(5,2)

04112223420L	COMPACT/SUS-4 4x20W. H.F. + 3 HCI-R111	1.585,09 €	(4,5)
04112223435L	COMPACT/SUS-4 4x35W. H.F. + 3 HCI-R111	2.137,38 €	(4,5)

Incluidos equipo electrónico y lámparas.

Suspensiones incluidas en el precio de la luminaria.

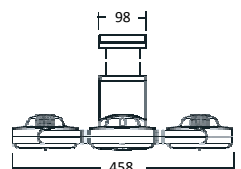
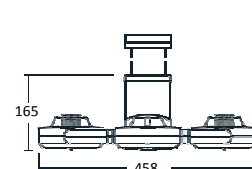
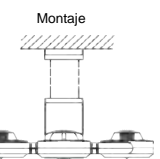
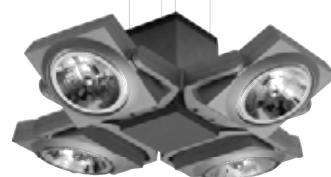

MULTIDIRECCIONALES CON LAMPARAS

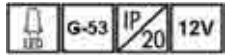

EMPOTRABLES LXR-111-LED

Materiales: Cuerpo en aluminio y chapa de acero esmaltado en color gris.

CODIGO	REFERENCIA	Comparable con	Flujo luminoso	P.V.P.	Kg.
04010L00810L	LXR-111-LED-1R-1x10W/827	1x50W.	620 lm	182,31 €	(2,2)
04010L00815L	LXR-111-LED-1R-1x15W/827	1x75W.	860 lm	198,39 €	(2,2)
04010L00910L	LXR-111-LED-2R-2x10W/827	2x50W.	1240 lm	336,97 €	(2,2)
04010L00915L	LXR-111-LED-2R-2x15W/827	2x75W.	1720 lm	367,47 €	(2,2)
04010L01010L	LXR-111-LED-3R-3x10W/827	3x50W.	1860 lm	493,91 €	(2,9)
04010L01015L	LXR-111-LED-3R-3x15W/827	3x75W.	2580 lm	547,76 €	(2,9)
04010L01110L	LXR-111-LED-4R-4x10W/827	4x50W.	2480 lm	634,06 €	(3,8)
04010L01115L	LXR-111-LED-4R-4x15W/827	4x75W.	3440 lm	703,17 €	(3,8)

Lamparas LED Philips Dimables incluidas.

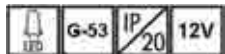

EMPOTRABLES RS-111-LED

Materiales: Cuerpo en aluminio y chapa de acero esmaltado en color blanco.

CODIGO	REFERENCIA	Comparable con	Flujo luminoso	P.V.P.	Kg.
04010L01510L	RS-111-LED-1R-1x10W/827	1x50W.	620 lm	184,80 €	(2,2)
04010L01515L	RS-111-LED-1R-1x15W/827	1x75W.	860 lm	200,88 €	(2,2)
04010L01610L	RS-111-LED-2R-2x10W/827	2x50W.	1240 lm	340,89 €	(2,1)
04010L01615L	RS-111-LED-2R-2x15W/827	2x75W.	1720 lm	371,39 €	(2,1)
04010L01710L	RS-111-LED-3R-3x10W/827	3x50W.	1860 lm	498,56 €	(2,9)
04010L01715L	RS-111-LED-3R-3x15W/827	3x75W.	2580 lm	552,42 €	(2,9)
04010L01810L	RS-111-LED-4R-4x10W/827	4x50W.	2480 lm	636,99 €	(3,6)
04010L01815L	RS-111-LED-4R-4x15W/827	4x75W.	3440 lm	706,09 €	(3,6)
04010L01910L	RS-111-LED-4C-4x10W/827	4x50W.	2480 lm	636,09 €	(3,5)
04010L01915L	RS-111-LED-4C-4x15W/827	4x75W.	3440 lm	706,09 €	(3,5)

Lamparas LED Philips Dimables incluidas.

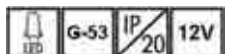

EMPOTRABLES RSMR-LED

Materiales: Cuerpo en aluminio y chapa de acero esmaltado en color gris.

CODIGO	REFERENCIA	Comparable con	Flujo luminoso	P.V.P.	Kg.
04110L05304L	RSMR-LED-1R-1x4W/827	1x20W.	220 lm	90,43 €	(2,0)
04110L05307L	RSMR-LED-1R-1x7W/827	1x35W.	330 lm	118,71 €	(2,0)
04110L05310L	RSMR-LED-1R-1x10W/827	1x50W.	410 lm	129,58 €	(2,0)
04110L05204L	RSMR-LED-2R-2x4W/827	2x20W.	440 lm	142,22 €	(2,6)
04110L05207L	RSMR-LED-2R-2x7W/827	2x35W.	660 lm	198,77 €	(2,6)
04110L05210L	RSMR-LED-2R-2x10W/827	2x50W.	820 lm	148,71 €	(1,9)
04110L05104L	RSMR-LED-3R-3x4W/827	3x20W.	660 lm	184,33 €	(3,1)
04110L05107L	RSMR-LED-3R-3x7W/827	3x35W.	990 lm	269,15 €	(3,1)
04110L05110L	RSMR-LED-3R-3x10W/827	3x50W.	1230 lm	301,77 €	(2,4)
04110L05004L	RSMR-LED-4R-4x4W/827	4x20W.	880 lm	228,61 €	(2,9)
04110L05007L	RSMR-LED-4R-4x7W/827	4x35W.	1320 lm	341,71 €	(2,9)
04110L05010L	RSMR-LED-4R-4x10W/827	4x50W.	1640 lm	385,20 €	(2,9)

Lamparas LED Philips Dimables incluidas.

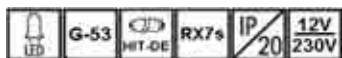

EMPOTRABLES LXR-111-LED-HIT-DE

Materiales: Cuerpo en aluminio y chapa de acero esmaltado en color gris.

CODIGO	REFERENCIA	Comparable con	Flujo luminoso	P.V.P.	Kg.
04010L013101L	LXR-111-2X10/827LED+70HIT-DE	2x50+70W.	7040lm	618,26 €	(7,0)
04010L013102L	LXR-111-2X10/827LED+150HIT-DE	2x50+150W.	14240lm	656,74 €	(7,8)
04110L013151L	LXR-111-2X15/827LED+70HIT-DE	2x75+70W.	7520lm	648,76 €	(7,0)
04110L013152L	LXR-111-2X15/827LED+150HIT-DE	2x75+150W.	14720lm	687,25 €	(7,8)

Lamparas LED Philips Dimables incluidas.

Montaje



Philips LED AR111



Philips LED AR111



Philips LED MR16



Philips LED AR111



HIT-DE



MULTIDIRECCIONALES CON LAMPARAS

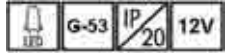

EMPOTRABLES



Materiales: Cuerpo en aluminio y chapa de acero esmaltado en color gris.

CODIGO	REFERENCIA	Comparable con	Flujo luminoso	P.V.P.	Kg.
04010L01410L	LXR-111-LED-1RD-10W/827	1x50W.	620 lm	178,03 €	(1,5)
04010L01415L	LXR-111-LED-1RD-15W/827	1x75W.	860 lm	194,10 €	(1,5)

Lamparas LED Philips Dimables incluidas.

04010L00410L	EXT-111-LED-10W/827	1x50W.	620 lm	195,61 €	(2,0)
04010L00415L	EXT-111-LED-15W/827	1x75W.	860 lm	211,68 €	(2,0)

Lamparas LED Philips Dimables incluidas.

Materiales: Cuerpo en aluminio y chapa de acero esmaltado en color oro.

04110L027010L	RSH-ORO-LED-10W/827	1x50W.	620 lm	179,07 €	(1,3)
04110L027015L	RSH-ORO-LED-15W/827	1x75W.	860 lm	195,15 €	(1,3)

Lamparas LED Philips Dimables incluidas.



Montaje

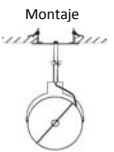

Montaje

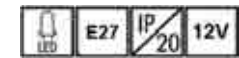
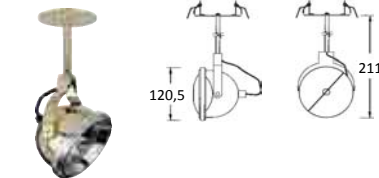

EMPOTRABLES

Materiales: Cuerpo en aluminio y chapa de acero esmaltado en color gris.

CODIGO	REFERENCIA	Comparable con	Flujo luminoso	P.V.P.	Kg.
04010L02912L	LXR-PAR30S-LED-12W/827	1x75W.	630 lm	201,64 €	(1,7)

Lamparas LED Philips Dimables incluidas.

04010L03112L	EXT-PAR30S-LED-12W/827	1x75W.	630 lm	219,89 €	(2,0)
--------------	-------------------------------	--------	--------	-----------------	-------

Lamparas LED Philips Dimables incluidas.



Montaje

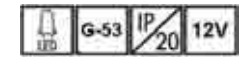
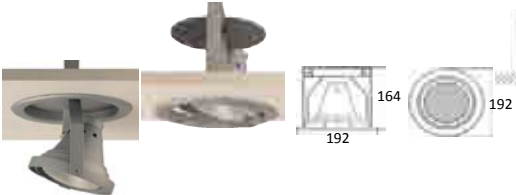

ADOSABLES

Materiales: Cuerpo en aluminio y chapa de acero esmaltado en color gris.

CODIGO	REFERENCIA	Comparable con	Flujo luminoso	P.V.P.	Kg.
04010L00510L	LXBL-111-LED-4x10W/827	4x50W.	2480 lm	794,86 €	(5,1)
04010L00515L	LXBL-111-LED-4x15W/827	4x75W.	3440 lm	863,96 €	(5,1)

Lamparas LED Philips Dimables incluidas.

04010L00610L	LXBC-111-LED-4x10W/827	4x50W.	2480 lm	748,16 €	(4,7)
04010L00615L	LXBC-111-LED-4x15W/827	4x75W.	3440 lm	817,26 €	(4,7)

Lamparas LED Philips Dimables incluidas.

04010L00410L	LXS-111-LED-2x10W/827	2x50W.	1240 lm	356,37 €	(1,5)
04010L00415L	LXS-111-LED-2x15W/827	2x75W.	1720 lm	386,88 €	(1,5)

04010L00410L	LXS-111-LED-8x10W/827	8x50W.	4960 lm	1.624,36 €	(8,6)
04010L00415L	LXS-111-LED-8x15W/827	8x75W.	6880 lm	1.764,76 €	(8,7)

04010L00410L	LXS-111-LED-8x10W/827	8x50W.	4960 lm	1.624,36 €	(8,6)
04010L00415L	LXS-111-LED-8x15W/827	8x75W.	6880 lm	1.764,76 €	(8,7)

04010L00410L	LXS-111-LED-8x10W/827	8x50W.	4960 lm	1.624,36 €	(8,6)
04010L00415L	LXS-111-LED-8x15W/827	8x75W.	6880 lm	1.764,76 €	(8,7)

04010L00410L	LXS-111-LED-8x10W/827	8x50W.	4960 lm	1.624,36 €	(8,6)
04010L00415L	LXS-111-LED-8x15W/827	8x75W.	6880 lm	1.764,76 €	(8,7)

04010L00410L	LXS-111-LED-8x10W/827	8x50W.	4960 lm	1.624,36 €	(8,6)
04010L00415L	LXS-111-LED-8x15W/827	8x75W.	6880 lm	1.764,76 €	(8,7)

04010L00410L	LXS-111-LED-8x10W/827	8x50W.	4960 lm	1.624,36 €	(8,6)
04010L00415L	LXS-111-LED-8x15W/827	8x75W.	6880 lm	1.764,76 €	(8,7)

04010L00410L	LXS-111-LED-8x10W/827	8x50W.	4960 lm	1.624,36 €	(8,6)
04010L00415L	LXS-111-LED-8x15W/827	8x75W.	6880 lm	1.764,76 €	(8,7)

04010L00410L	LXS-111-LED-8x10W/827	8x50W.	4960 lm	1.624,36 €	(8,6)
04010L00415L	LXS-111-LED-8x15W/827	8x75W.	6880 lm	1.764,76 €	(8,7)

04010L00410L	LXS-111-LED-8x10W/827	8x50W.	4960 lm	1.624,36 €	(8,6)
04010L00415L	LXS-111-LED-8x15W/827	8x75W.	6880 lm	1.764,76 €	(8,7)

04010L00410L	LXS-111-LED-8x10W/827	8x50W.	4960 lm	1.624,36 €	(8,6)
04010L00415L	LXS-111-LED-8x15W/827	8x75W.	6880 lm	1.764,76 €	(8,7)

04010L00410L	LXS-111-LED-8x10W/827	8x50W.	4960 lm	1.624,36 €	(8,6)
04010L00415L	LXS-111-LED-8x15W/827	8x75W.	6880 lm	1.764,76 €	(8,7)

04010L00410L	LXS-111-LED-8x10W/827	8x50W.	4960 lm	1.624,36 €	(8,6)
04010L00415L	LXS-111-LED-8x15W/827	8x75W.	6880 lm	1.764,76 €	(8,7)

04010L00410L	LXS-111-LED-8x10W/827	8x50W.	4960 lm	1.624,36 €	(8,6)
04010L00415L	LXS-111-LED-8x15W/827	8x75W.	6880 lm	1.764,76 €	(8,7)

04010L00410L	LXS-111-LED-8x10W/827	8x50W.	4960 lm	1.624,36 €	(8,6)
04010L00415L	LXS-111-LED-8x15W/827	8x75W.	6880 lm	1.764,76 €	(8,7)

04010L00410L	LXS-111-LED-8x10W/827	8x50W.	4960 lm	1.624,36 €	(8,6)
04010L00415L	LXS-111-LED-8x15W/827	8x75W.	6880 lm	1.764,76 €	(8,7)

04010L00410L	LXS-111-LED-8x10W/827	8x50W.	4960 lm	1.624,36 €	(8,6)
04010L00415L	LXS-111-LED-8x15W/827	8x75W.	6880 lm	1.764,76 €	(8,7)

04010L00410L	LXS-111-LED-8x10W/827	8x50W.	4960 lm	1.624,36 €	(8,6)
04010L00415L	LXS-111-LED-8x15W/827	8x75W.	6880 lm	1.764,76 €	(8,7)

04010L00410L	LXS-111-LED-8x10W/827	8x50W.	4960 lm	1.624,36 €	(8,6)
04010L00415L	LXS-111-LED-8x15W/827	8x75W.	6880 lm	1.764,76 €	(8,7)

04010L00410L	LXS-111-LED-8x10W/827	8x50W.	4960 lm	1.624,36 €	(8,6)
04010L00415L	LXS-111-LED-8x15W/827	8x75W.	6880 lm	1.764,76 €	(8,7)

04010L00410L	LXS-111-LED-8x10W/827	8x50W.	4960 lm	1.624,36 €	(8,6)
04010L00415L	LXS-111-LED-8x15W/827	8x75W.	6880 lm	1.764,76 €	(8,7)

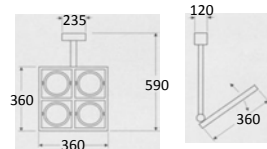

Montaje

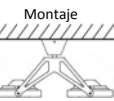
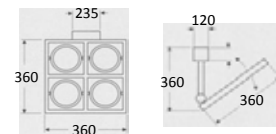

Montaje

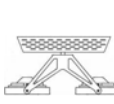

Montaje

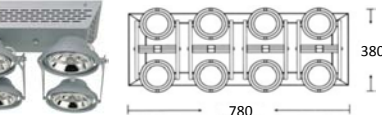

Montaje

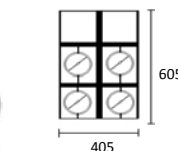

MULTIDIRECCIONALES

Materiales: Cuerpo en aluminio y chapa de acero esmaltada en color gris.

PENDULARES

Equipos y lámparas no incluidos (Bajo consulta).

CODIGO	REFERENCIA	P.V.P.	Kg.
040100001	LX-111-10 a 12V. 50/75/100W.	362,39 €	(9,1)

Suspensiones incluidas en el precio de la luminaria.

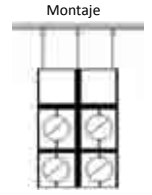
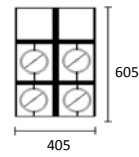

Materiales: Cuerpo en aluminio y chapa de acero esmaltada en color gris.

ADOSABLES

Equipos y lámparas no incluidos (Bajo consulta).

040100005	LXBL-111-4 a 12V. 50/75/100W.	223,61 €	(5,0)
-----------	-------------------------------	----------	-------

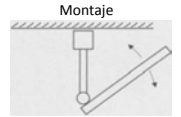
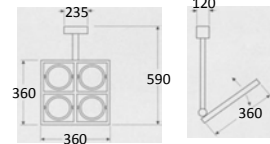

040100006	LXBC-111-4 a 12V. 50/75/100W.	183,02 €	(4,6)
-----------	-------------------------------	----------	-------

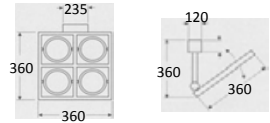

Materiales: Cuerpo en aluminio y chapa de acero esmaltada en color gris.

Equipos y lámparas no incluidos (Bajo consulta).

040100004	LXS-111-2 a 12V. 50/75/100W.	71,96 €	(1,4)
-----------	------------------------------	---------	-------

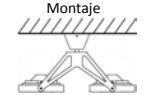
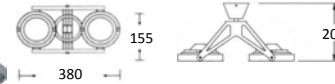

040100003	LXS-111-4 a 12V. 50/75/100W.	218,04 €	(4,2)
-----------	------------------------------	----------	-------

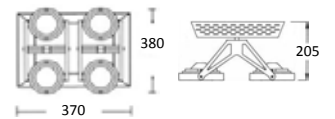

040100002	LXS-111-8 a 12V. 50/75/100W.	477,39 €	(8,5)
-----------	------------------------------	----------	-------

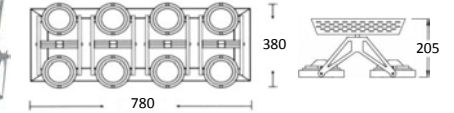

Materiales: Cuerpo en aluminio y chapa de acero esmaltada en color gris.

EMPOTRABLES

Equipos y lámparas no incluidos (Bajo consulta).

040100013	LXR-111-3-HQI a 12V. a 230V. 70/150W.	213,70 €	(5,4)
-----------	--	----------	-------

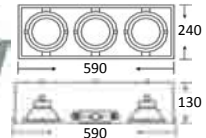

Materiales: Cuerpo en aluminio y chapa de acero esmaltado.

Equipos y lámparas no incluidos (Bajo consulta).

040100014	LXR-111-1RD a 12V. 50/75/100W.	31,52 €	(0,7)
-----------	--------------------------------	---------	-------

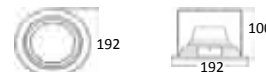
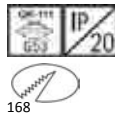

Materiales: Cuerpo en aluminio y chapa de acero esmaltado en color gris.

Equipos y lámparas no incluidos (Bajo consulta).

040100008	LXR-111-1R a 12V. 50/75/100W.	35,00 €	(1,4)
-----------	-------------------------------	---------	-------

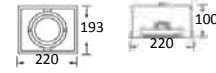

040100009	LXR-111-2R a 12V. 50/75/100W.	55,15 €	(2,1)
-----------	-------------------------------	---------	-------

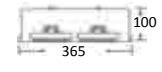
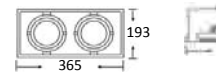

040100010	LXR-111-3R a 12V. 50/75/100W.	77,25 €	(2,8)
-----------	-------------------------------	---------	-------

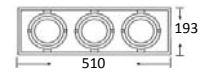

040100011	LXR-111-4R a 12V. 50/75/100W.	79,73 €	(3,7)
-----------	-------------------------------	---------	-------



MULTIDIRECCIONALES

EMPOTRABLES

Materiales: Cuerpo en aluminio y chapa de acero esmaltado en color gris.

Equipos y lámparas no incluidos (Bajo consulta).

040100029	LXR-PAR30S a 230V. 75W.	48,15 € (0,9)
(NO NECESITA EQUIPO)		

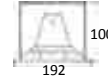
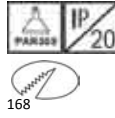

Materiales: Cuerpo en aluminio y chapa de acero esmaltado en color gris.

Equipos y lámparas no incluidos (Bajo consulta).

040100030	LXL-PAR30L a 230V. 35/75W.	33,60 € (1,0)
-----------	-----------------------------------	----------------------

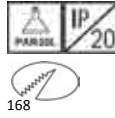

Materiales: Cuerpo en aluminio y chapa de acero esmaltado en color gris.

Equipos y lámparas no incluidos (Bajo consulta).

040100031	EXT-PAR30S a 230V. 75W.	63,89 € (1,2)
(NO NECESITA EQUIPO)		

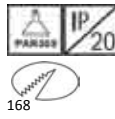

Materiales: Cuerpo en aluminio y chapa de acero esmaltado en color gris.

Equipos y lámparas no incluidos (Bajo consulta).

040100040	EXT-111 a 12V. 50/75/100W.	46,86 € (1,2)
-----------	-----------------------------------	----------------------

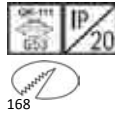

ADOSABLES

Materiales: Cuerpo en aluminio y chapa de acero esmaltado en color oro.

Equipos y lámparas no incluidos (Bajo consulta).

0411000270	RSH ORO a 12V. 50/75/100W.	32,51 € (0,5)
------------	-----------------------------------	----------------------

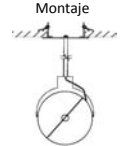
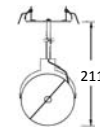
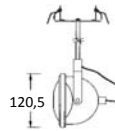
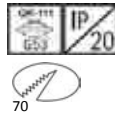

Materiales: Cuerpo en aluminio y chapa de acero esmaltado en color blanco.

Equipos y lámparas no incluidos (Bajo consulta).

041100015	RS-111-1R a 12V. 50/75/100W.	37,35 € (1,4)
-----------	-------------------------------------	----------------------

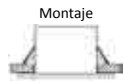
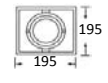
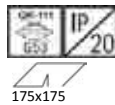

041100016	RS-111-2R a 12V. 50/75/100W.	58,82 € (2,0)
-----------	-------------------------------------	----------------------

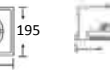
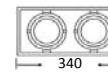

041100017	RS-111-3R a 12V. 50/75/100W.	81,62 € (2,8)
-----------	-------------------------------------	----------------------

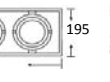
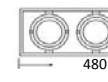

041100018	RS-111-4R a 12V. 50/75/100W.	77,64 € (3,5)
-----------	-------------------------------------	----------------------



041100019	RS-111-4C a 12V. 50/75/100W.	77,22 € (3,4)
-----------	-------------------------------------	----------------------

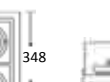

MULTIDIRECCIONALES EMPOTRABLES

Materiales: Cuerpo en aluminio y chapa de acero esmaltado en color gris.

Equipos y lámparas no incluidos (Bajo consulta).

041100053 **RSMR-1R** a 12V. 35/50W. **40,38 €** (1,2)

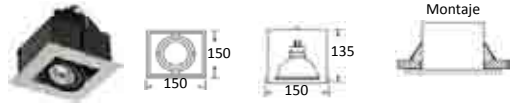

041100052 **RSMR-2R** a 12V. 35/50W. **56,40 €** (1,8)

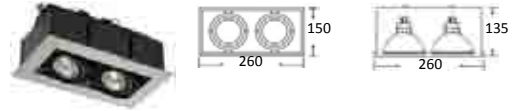

041100051 **RSMR-3R** a 12V. 35/50W. **64,06 €** (2,3)

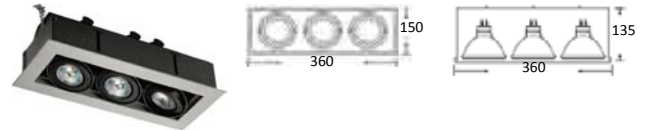

041100050 **RSMR-4R** a 12V. 35/50W. **73,60 €** (2,8)

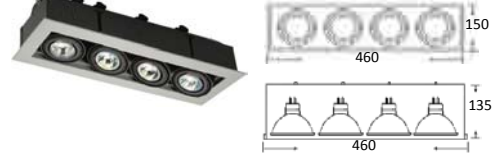

Materiales: Cuerpo en aluminio y chapa de acero esmaltado en color gris.

Equipos y lámparas no incluidos (Bajo consulta).

041100041 **RS-1R-PAR30L** a 230V. 35/70W. **52,15 €** (1,9)

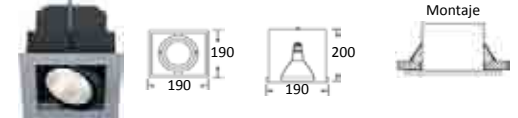
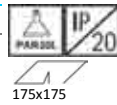

041100042 **RS-2R-PAR30L** a 230V. 35/70W. **77,66 €** (2,7)

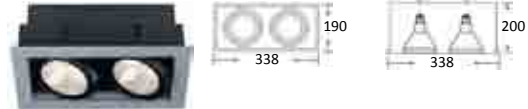

041100043 **RS-3R-PAR30L** a 230V. 35/70W. **85,28 €** (3,7)

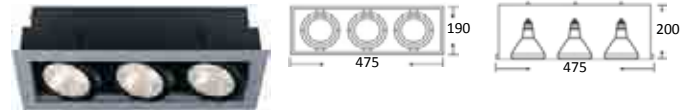

041100044 **RS-4R-PAR30L** a 230V. 35/70W. **120,57 €** (4,6)



041100045 **RS-4C-PAR30L** a 230V. 35/70W. **120,15 €** (4,5)

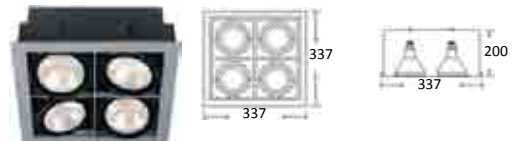

DOWNLIGHTS EMPOTRABLES



Materiales: Cuerpo en acero esmaltado en color blanco, reflector de aluminio Miro 4.

CODIGO	REFERENCIA	Indice rendimiento de color CRI (Ra)	Temperatura de color CCT (k)	P.V.P.	Kg.
DSQL015	HERA-225 LED-1x15W. 1050 lm/830	>80	3000	420,65 €	(2,0)
DSQL013	HERA-225 LED-1x13W. 1050lm/840	>80	4000	420,65 €	(2,0)
DSQL028	HERA-225 LED-1x28W. 1950lm/830	>80	3000	510,59 €	(2,0)
DSQL026	HERA-225 LED-1x26W. 1950lm/840	>80	4000	510,59 €	(2,0)
DSQL050	HERA-225 LED-1x50W. 2950lm/830	>80	3000	561,83 €	(2,0)
DSQL046	HERA-225 LED-1x46W. 2950lm/840	>80	4000	561,83 €	(2,0)

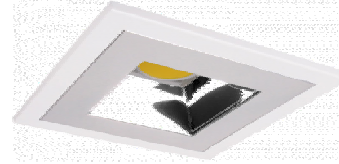
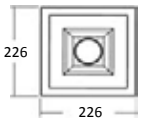
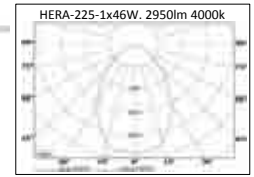
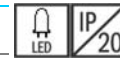

Materiales: Cuerpo en PBT, material compuesto con fibra de vidrio con placa metálica portaequipos, reflector de policarbonato con baño de aluminio brillante "HYDRA-240" o policarbonato lacado en color blanco con máxima eficiencia lumínica "HYDRA-WHITE-240".

CODIGO	REFERENCIA	Indice rendimiento de color CRI (Ra)	Temperatura de color CCT (k)	P.V.P.	Kg.
0321701316	HYDRA-240 LED 1x16W. 1100/840	80	4000	431,32 €	(1,8)
0321701318	HYDRA-240 LED 1x18W. 1100/830	80	3000	442,41 €	(1,8)
0321701326	HYDRA-240 LED 1x26W. 2000/840	80	4000	557,12 €	(1,8)
0321701328	HYDRA-240 LED 1x28W. 2000/830	80	3000	557,12 €	(1,8)
0321701346	HYDRA-240 LED 1x46W. 3000/840	80	4000	603,99 €	(1,8)
0321701350	HYDRA-240 LED 1x50W. 3000/830	80	4000	488,29 €	(1,8)
0321701840	HYDRA-240 LED 1x40W. DALI/DMX RGB 1100	80	RGB	1.187,60 €	(1,8)
0321702316	HYDRA-WHITE-240 LED 1x16W. 1100/840	80	4000	431,32 €	(1,8)
0321702318	HYDRA-WHITE-240 LED 1x18W. 1100/830	80	3000	442,41 €	(1,8)
0321702326	HYDRA-WHITE-240 LED 1x26W. 2000/840	80	4000	557,12 €	(1,8)
0321702328	HYDRA-WHITE-240 LED 1x28W. 2000/830	80	3000	557,12 €	(1,8)
0321702346	HYDRA-WHITE-240 LED 1x46W. 3000/840	80	4000	603,99 €	(1,8)
0321702350	HYDRA-WHITE-240 LED 1x50W. 3000/830	80	4000	488,29 €	(1,8)
0321702840	HYDRA-WHITE-240 LED 1x40W. DALI/DMX RGB 1100	80	RGB	1.187,60 €	(1,8)

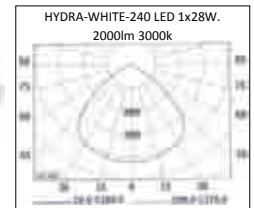
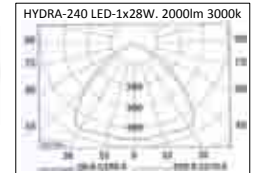

Opcional: Elementos decorativos, anillos y cristales. Consultar accesorios disponibles.

Conector Wieland GST 18i3 o Wago Winsta 770, bajo consulta (Conector estándar: 3 polos - rápida).

Bajo consulta, equipo de control electrónico regulable (EEI=A1 - DALI/DMX).

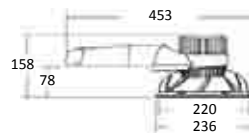
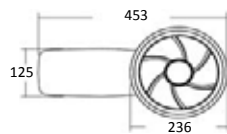

Materiales: Cuerpo en policarbonato con aro de chapa de acero, reflector de aluminio brillante.

CODIGO	REFERENCIA	Indice rendimiento de color CRI (Ra)	Temperatura de color CCT (k)	P.V.P.	Kg.
03218181271	ELITE-1 LED 1x27W. DALI 2000lm/930	>93	3000	747,35 €	(2,5)
03218181272	ELITE-1 LED 1x27W. DALI 2000lm/940	>93	4000	747,35 €	(2,5)
03218181371	ELITE-1 LED 1x37W. DALI 2900lm/930	>93	3000	919,52 €	(2,5)
03218181372	ELITE-1 LED 1x37W. DALI 2900lm/940	>93	4000	919,52 €	(2,5)

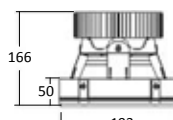
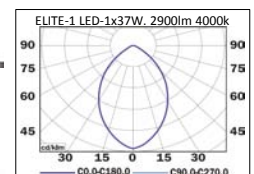

DOWNLIGHTS EMPOTRABLES



Materiales: Cuerpo en policarbonato con aro de chapa de acero, reflector de aluminio brillante.

CODIGO	REFERENCIA	Indice rendimiento de color CRI (Ra)	Temperatura de color CCT (k)	P.V.P.	Kg.
03218231120	ELITE-2 LED 1x12W. 700lm/927	>93	2700	249,00 €	(1,8)
03218281271	ELITE-2 LED 1x27W. DALI 2000lm/930	>93	3000	508,97 €	(1,8)
03218281272	ELITE-2 LED 1x27W. DALI 2000lm/940	>93	4000	508,97 €	(1,8)
03218281371	ELITE-2 LED 1x37W. DALI 2900lm/930	>93	3000	655,31 €	(1,8)
03218281372	ELITE-2 LED 1x37W. DALI 2900lm/940	>93	4000	655,31 €	(1,8)

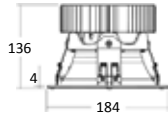
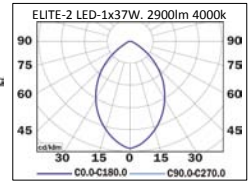
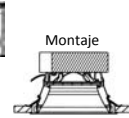

Materiales: Cuerpo en chapa de acero, reflector de aluminio brillante.

CODIGO	REFERENCIA	Indice rendimiento de color CRI (Ra)	Temperatura de color CCT (k)	P.V.P.	Kg.
DC00L1100	DC-230 LED-12W. 1100lm/840	>80	4000	272,58 €	(1,8)
DC00L2000	DC-230 LED-20W. 2000lm/840	>80	4000	317,39 €	(1,8)
DC00L3000	DC-230 LED-36W. 3000lm/840	>80	4000	341,80 €	(1,8)

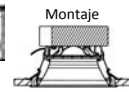

ACCESORIOS

DC000001	CRISTAL CIERRE DC-230 LED			32,20 €	---
----------	----------------------------------	--	--	----------------	-----

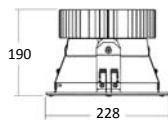

Materiales: Cuerpo en chapa de acero, reflector de aluminio brillante.

CODIGO	REFERENCIA	Indice rendimiento de color CRI (Ra)	Temperatura de color CCT (k)	P.V.P.	Kg.
DSQ0L1100	DSQ-230 LED-12W. 1100lm/840	>80	4000	272,58 €	(1,8)
DSQ0L2000	DSQ-230 LED-20W. 2000lm/840	>80	4000	317,39 €	(1,8)
DSQ0L3000	DSQ-230 LED-36W. 3000lm/840	>80	4000	341,80 €	(1,8)

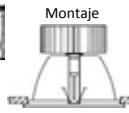

ACCESORIOS

DSQ000001	CRISTAL CIERRE DSQ-230 LED			32,20 €	---
-----------	-----------------------------------	--	--	----------------	-----

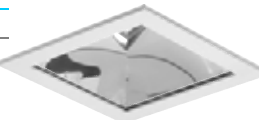
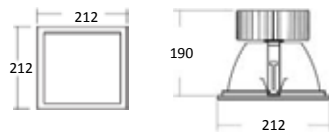

Materiales: Cuerpo en aluminio con aro de aluminio pintado en blanco, difusor de PMMA opal.

CODIGO	REFERENCIA	Indice rendimiento de color CRI (Ra)	Temperatura de color CCT (k)	P.V.P.	Kg.
DS1L017B1	SATELITE/C-195-17W/830	>80	3000	136,44 €	(0,6)
DS1L017B2	SATELITE/C-195-17W/860	>80	6000	136,44 €	(0,6)

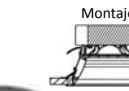

DS1L021B1	SATELITE/C-235-21W/830	>80	3000	181,49 €	(0,6)
DS1L021B2	SATELITE/C-235-21W/860	>80	6000	181,49 €	(0,6)

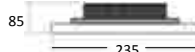

DOWNLIGHTS EMPOTRABLES



Materiales: Cuerpo en acero galvanizado, reflector parabólico turbo de aluminio anodizado brillante.

CODIGO	REFERENCIA	P.V.P.	Kg.
03215022113	DEL-195-1x13W. 230V. A.F.	46,74 €	(1,4)
03215022118	DEL-195-1x18W. 230V. A.F.	46,74 €	(1,4)
03215022126	DEL-195-1x26W. 230V. A.F.	46,74 €	(1,6)
03215022213	DEL-195-2x13W. 230V. A.F.	55,26 €	(1,7)
03215022218	DEL-195-2x18W. 230V. A.F.	55,26 €	(1,7)
03215022226	DEL-195-2x26W. 230V. A.F.	55,26 €	(2,1)



DEL-195		
DEL/C-195		

03315023118	DEL/C-195-1x18W. H.F.	78,04 €	(1,2)
03315023126	DEL/C-195-1x26W. H.F.	78,04 €	(1,2)
03315023218	DEL/C-195-2x18W. H.F.	85,93 €	(1,3)
03315023226	DEL/C-195-2x26W. H.F.	85,93 €	(1,3)

03215012118	DEL-230-1x18W. 230V. A.F.	57,18 €	(1,6)
03215012126	DEL-230-1x26W. 230V. A.F.	57,18 €	(1,8)
03215012218	DEL-230-2x18W. 230V. A.F.	66,07 €	(1,9)
03215012226	DEL-230-2x26W. 230V. A.F.	66,07 €	(2,3)
03315013118	DEL/C-230-1x18W. H.F.	88,86 €	(1,4)
03315013126	DEL/C-230-1x26W. H.F.	88,86 €	(1,4)
03315013218	DEL/C-230-2x18W. H.F.	93,59 €	(1,5)
03315013226	DEL/C-230-2x26W. H.F.	93,59 €	(1,5)



DEL-230		
DEL/C-230		

03315063132	DEL/C-265-1x32W. H.F.	105,87 €	(1,6)
03315063142	DEL/C-265-1x42W. H.F.	105,87 €	(1,6)
03315063232	DEL/C-265-2x32W. H.F.	109,66 €	(1,7)



DEL/C-265		
-----------	--	--

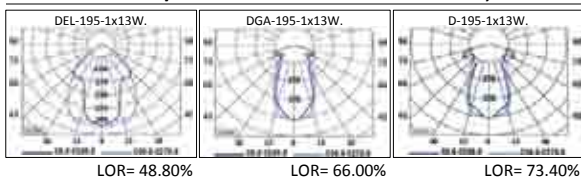

Materiales: Cuerpo en acero galvanizado, reflector de aluminio anodizado brillante, cristal suspendido transparente.

CODIGO	REFERENCIA	P.V.P.	Kg.
03215002113	DGA-195-1x13W. 230V. A.F.	59,54 €	(1,7)
03215002118	DGA-195-1x18W. 230V. A.F.	59,54 €	(1,7)
03215002126	DGA-195-1x26W. 230V. A.F.	59,54 €	(1,7)
03215002213	DGA-195-2x13W. 230V. A.F.	68,06 €	(2,0)
03215002218	DGA-195-2x18W. 230V. A.F.	68,06 €	(2,0)
03215002226	DGA-195-2x26W. 230V. A.F.	68,06 €	(2,3)



DGA-195		
DGA/C-195		

03315003118	DGA/C-195-1x18W. H.F.	89,73 €	(1,5)
03315003126	DGA/C-195-1x26W. H.F.	89,73 €	(1,5)
03315003218	DGA/C-195-2x18W. H.F.	93,52 €	(1,6)
03315003226	DGA/C-195-2x26W. H.F.	93,52 €	(1,6)

033150203132	DGA/C-230-1x32W. H.F.	100,95 €	(1,9)
033150203142	DGA/C-230-1x42W. H.F.	100,95 €	(1,9)
033150203226	DGA/C-230-2x26W. H.F.	104,78 €	(2,0)
033150203232	DGA/C-230-2x32W. H.F.	104,78 €	(2,0)



DGA/C-230		
-----------	--	--

Materiales: Cuerpo en acero galvanizado, reflector de aluminio anodizado brillante.

CODIGO	REFERENCIA	P.V.P.	Kg.
0321002113	D-195-1x13W. 230V. A.F.	40,96 €	(1,3)
0321002118	D-195-1x18W. 230V. A.F.	40,96 €	(1,3)
0321002126	D-195-1x26W. 230V. A.F.	40,96 €	(1,5)
0321002213	D-195-2x13W. 230V. A.F.	49,48 €	(1,8)
0321002218	D-195-2x18W. 230V. A.F.	49,48 €	(1,8)
0321002226	D-195-2x26W. 230V. A.F.	49,48 €	(2,0)



D-195		
D/C-195		

0331003118	D/C-195-1x18W. H.F.	70,77 €	(1,1)
0331003126	D/C-195-1x26W. H.F.	70,77 €	(1,1)
0331003218	D/C-195-2x18W. H.F.	77,67 €	(1,3)
0331003226	D/C-195-2x26W. H.F.	77,67 €	(1,3)

0331023132	D/C-230-1x32W. H.F.	80,08 €	(1,3)
0331023142	D/C-230-1x42W. H.F.	80,08 €	(1,3)
0331023226	D/C-230-2x26W. H.F.	83,91 €	(1,4)
0331023232	D/C-230-2x32W. H.F.	83,91 €	(1,4)



D/C-230		
---------	--	--

DOWNLIGHTS EMPOTRABLES

Montaje Mod. DF, D/ASY, DTM-IP44.



Montaje Mod. DF/C, DTM/C-IP44.



Materiales: Cuerpo en acero galvanizado, reflector de aluminio anodizado brillante facetado.

CODIGO	REFERENCIA	P.V.P.	Kg.
0321012113	DF-195-1x13W. 230V. A.F.	40,96 €	(1,3)
0321012118	DF-195-1x18W. 230V. A.F.	40,96 €	(1,3)
0321012126	DF-195-1x26W. 230V. A.F.	40,96 €	(1,5)
0321012213	DF-195-2x13W. 230V. A.F.	49,48 €	(1,8)
0321012218	DF-195-2x18W. 230V. A.F.	49,48 €	(1,8)
0321012226	DF-195-2x26W. 230V. A.F.	49,48 €	(2,0)

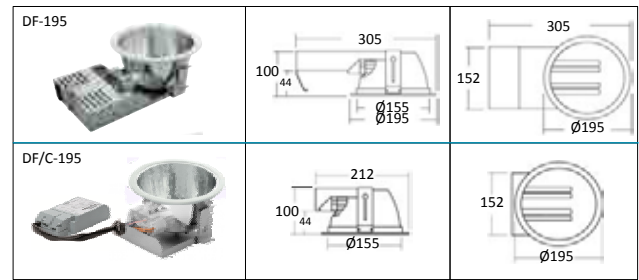

0331013118	DF/C-195-1x18W. H.F.	70,77 €	(1,1)
0331013126	DF/C-195-1x26W. H.F.	70,77 €	(1,1)
0331013218	DF/C-195-2x18W. H.F.	77,67 €	(1,3)
0331013226	DF/C-195-2x26W. H.F.	77,67 €	(1,3)

0331033132	DF/C-230-1x32W. H.F.	80,08 €	(1,3)
0331033142	DF/C-230-1x42W. H.F.	80,08 €	(1,3)
0331033226	DF/C-230-2x26W. H.F.	83,91 €	(1,4)
0331033232	DF/C-230-2x32W. H.F.	83,91 €	(1,4)

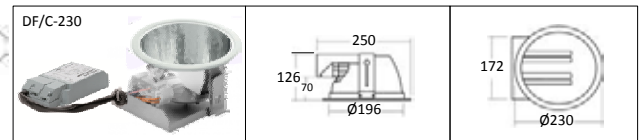

Materiales: Cuerpo en acero galvanizado, reflector de aluminio anodizado brillante facetado.

CODIGO	REFERENCIA	P.V.P.	Kg.
0322517460	DS-174-E27 75W MAX.	13,88€	(0,8)

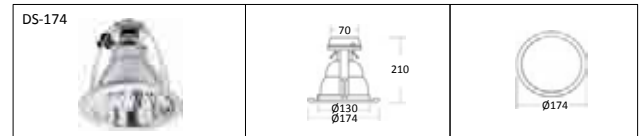

Materiales: Cuerpo en acero galvanizado, reflector de aluminio anodizado brillante asimétrico.

CODIGO	REFERENCIA	P.V.P.	Kg.
03210002113	D/ASY-230-1x13W. 230V. A.F.	62,77 €	(1,5)
03210002213	D/ASY-230-2x13W. 230V. A.F.	69,64 €	(1,8)
03210003113	D/ASY-230-1x13W. H.F.	95,24 €	(1,3)
03210003213	D/ASY-230-2x13W. H.F.	99,19 €	(1,4)

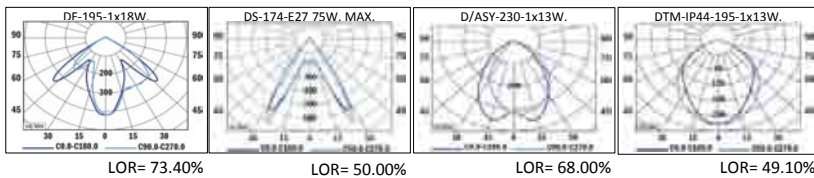
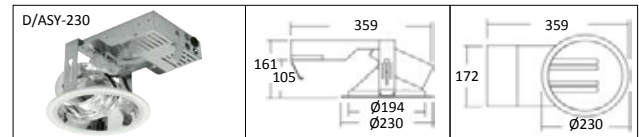

Materiales: Cuerpo en acero galvanizado, reflector de aluminio anodizado brillante, cubierto con un cristal mate.

CODIGO	REFERENCIA	P.V.P.	Kg.
0321102100	DTM-IP44-195-E27 75W MAX.	11,97 €	(1,1)
0321102113	DTM-IP44-195-1x13W. 230V. A.F.	43,62 €	(1,5)
0321102118	DTM-IP44-195-1x18W. 230V. A.F.	43,62 €	(1,5)
0321102126	DTM-IP44-195-1x26W. 230V. A.F.	43,62 €	(1,7)
0321102213	DTM-IP44-195-2x13W. 230V. A.F.	52,14 €	(1,8)
0321102218	DTM-IP44-195-2x18W. 230V. A.F.	52,14 €	(1,8)
0321102226	DTM-IP44-195-2x26W. 230V. A.F.	52,14 €	(2,3)

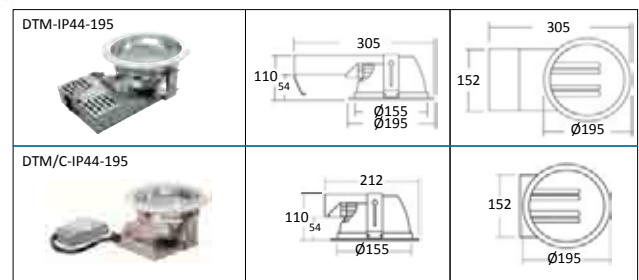

0331103118	DTM/C-IP44-195-1x18W. H.F.	74,75 €	(1,3)
0331103126	DTM/C-IP44-195-1x26W. H.F.	74,75 €	(1,3)
0331103218	DTM/C-IP44-195-2x18W. H.F.	82,36 €	(1,4)
0331103226	DTM/C-IP44-195-2x26W. H.F.	82,36 €	(1,4)

0321132118	DTM-IP44-230-1x18W. 230V. A.F.	53,80 €	(1,6)
0321132126	DTM-IP44-230-1x26W. 230V. A.F.	53,80 €	(1,9)
0321132218	DTM-IP44-230-2x18W. 230V. A.F.	63,07 €	(2,0)
0321132226	DTM-IP44-230-2x26W. 230V. A.F.	63,07 €	(2,4)
0331132118	DTM/C-IP44-230-1x18W. H.F.	85,48 €	(1,5)
0331132126	DTM/C-IP44-230-1x26W. H.F.	85,48 €	(1,5)
0331132218	DTM/C-IP44-230-2x18W. H.F.	91,64 €	(1,6)
0331132226	DTM/C-IP44-230-2x26W. H.F.	91,64 €	(1,6)

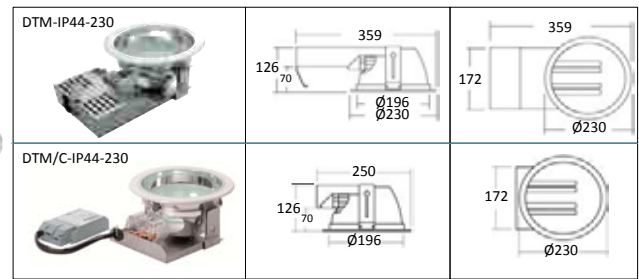

0331143132	DTM/C-IP44-265-1x32W. H.F.	104,40 €	(1,7)
0331143142	DTM/C-IP44-265-1x42W. H.F.	104,40 €	(1,7)
0331143226	DTM/C-IP44-265-2x26W. H.F.	108,68 €	(1,8)

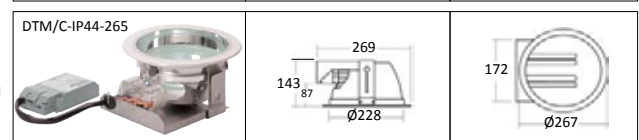

DOWNLIGHTS EMPOTRABLES

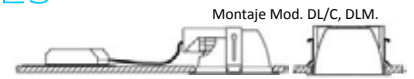
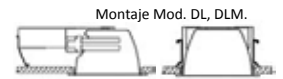

Materiales: Cuerpo en acero galvanizado, reflector de aluminio anodizado brillante, cristal cierre transparente.

CODIGO	REFERENCIA	P.V.P.	Kg.
0321112113	DL-195-1x13W. 230V. A.F.	71,81 €	(1,7)
0321112118	DL-195-1x18W. 230V. A.F.	71,81 €	(1,8)
0321112126	DL-195-1x26W. 230V. A.F.	71,81 €	(2,0)
0321112213	DL-195-2x13W. 230V. A.F.	80,23 €	(2,1)
0321112218	DL-195-2x18W. 230V. A.F.	80,23 €	(2,1)
0321112226	DL-195-2x26W. 230V. A.F.	80,23 €	(2,5)
0331113118	DL/C-195-1x18W. H.F.	104,85 €	(1,6)
0331113126	DL/C-195-1x26W. H.F.	104,85 €	(1,6)
0331113218	DL/C-195-2x18W. H.F.	112,92 €	(1,7)
0331113226	DL/C-195-2x26W. H.F.	112,92 €	(1,7)



DL-195		
DL/C-195		

Materiales: Cuerpo en acero galvanizado, reflector de aluminio anodizado brillante, cristal cierre transparente.

CODIGO	REFERENCIA	P.V.P.	Kg.
0322102118	DL-230-1x18W. 230V. A.F.	96,61 €	(2,1)
0322102126	DL-230-1x26W. 230V. A.F.	96,61 €	(2,3)
0322102218	DL-230-2x18W. 230V. A.F.	101,04 €	(2,5)
0322102226	DL-230-2x26W. 230V. A.F.	101,04 €	(2,9)
0332103118	DL/C-230-1x18W. H.F.	117,48 €	(2,0)
0332103126	DL/C-230-1x26W. H.F.	117,48 €	(2,0)
0332103132	DL/C-230-1x32W. H.F.	117,48 €	(2,0)
0332103142	DL/C-230-1x42W. H.F.	117,48 €	(2,0)
0332103218	DL/C-230-2x18W. H.F.	121,46 €	(2,1)
0332103226	DL/C-230-2x26W. H.F.	121,46 €	(2,1)
0332103232	DL/C-230-2x32W. H.F.	121,46 €	(2,1)



DL-230		
DL/C-230		

Materiales: Cuerpo en acero galvanizado, reflector de aluminio anodizado brillante, cristal cierre transparente.

CODIGO	REFERENCIA	P.V.P.	Kg.
0332123132	DL/C-265-1x32W. H.F.	139,26 €	(2,2)
0332123142	DL/C-265-1x42W. H.F.	139,26 €	(2,2)
0332123232	DL/C-265-2x32W. H.F.	144,47 €	(2,3)



DL/C-265		
----------	--	--

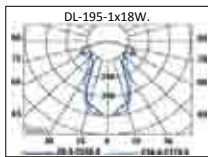

LOR= 69.10%

Materiales: Cuerpo en acero galvanizado, reflector de aluminio anodizado brillante, cristal cierre mate.

CODIGO	REFERENCIA	P.V.P.	Kg.
0321122113	DLM-195-1x13W. 230V. A.F.	76,13 €	(1,7)
0321122118	DLM-195-1x18W. 230V. A.F.	76,13 €	(1,8)
0321122126	DLM-195-1x26W. 230V. A.F.	76,13 €	(2,0)
0321122213	DLM-195-2x13W. 230V. A.F.	84,24 €	(2,1)
0321122218	DLM-195-2x18W. 230V. A.F.	84,24 €	(2,1)
0321122226	DLM-195-2x26W. 230V. A.F.	84,24 €	(2,5)
0321123118	DLM/C-195-1x18W. H.F.	109,17 €	(1,6)
0321123126	DLM/C-195-1x26W. H.F.	109,17 €	(1,6)
0321123218	DLM/C-195-2x18W. H.F.	117,24 €	(1,7)
0321123226	DLM/C-195-2x26W. H.F.	117,24 €	(1,7)

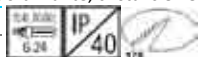

DLM-195		
DLM/C-195		

Materiales: Cuerpo en acero galvanizado, reflector de aluminio anodizado brillante, cristal cierre mate.

CODIGO	REFERENCIA	P.V.P.	Kg.
0322112118	DLM-230-1x18W. 230V. A.F.	100,59 €	(2,1)
0322112126	DLM-230-1x26W. 230V. A.F.	100,59 €	(2,3)
0322112218	DLM-230-2x18W. 230V. A.F.	105,02 €	(2,5)
0322112226	DLM-230-2x26W. 230V. A.F.	105,02 €	(2,9)
0322113118	DLM/C-230-1x18W. H.F.	121,46 €	(2,0)
0322113126	DLM/C-230-1x26W. H.F.	121,46 €	(2,0)
0322113132	DLM/C-230-1x32W. H.F.	121,46 €	(2,0)
0322113142	DLM/C-230-1x42W. H.F.	121,46 €	(2,0)
0322113218	DLM/C-230-2x18W. H.F.	125,43 €	(2,1)
0322113226	DLM/C-230-2x26W. H.F.	125,43 €	(2,1)
0322113232	DLM/C-230-2x32W. H.F.	125,43 €	(2,1)

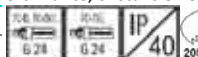

DLM-230		
DLM/C-230		

Materiales: Cuerpo en acero galvanizado, reflector de aluminio anodizado brillante, cristal cierre mate.

CODIGO	REFERENCIA	P.V.P.	Kg.
0322133132	DLM/C-265-1x32W. H.F.	144,89 €	(2,2)
0322133142	DLM/C-265-1x42W. H.F.	144,89 €	(2,2)
0322133232	DLM/C-265-2x32W. H.F.	150,10 €	(2,3)

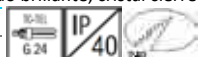

DLM/C-265		
-----------	--	--

DOWNLIGHTS EMPOTRABLES MAXI

Materiales: Cuerpo en acero galvanizado, reflector de aluminio anodizado brillante.

CODIGO	REFERENCIA	P.V.P.	Kg.	3000	3000	IP
0321043232	MAXI-320-2x32W. H.F.	99,30 €	(2,1)	6.24	6.24	20
0321043326	MAXI-320-3x26W. H.F.	132,57 €	(2,3)			
0321043332	MAXI-320-3x32W. H.F.	132,57 €	(2,3)			

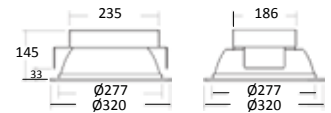
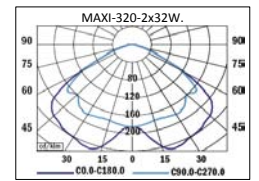

---	MARCO CROMO MAXI	24,37 €	-
(Incrementar al precio de la luminaria)			



---	MARCO ORO MAXI	58,34 €	-
(Incrementar al precio de la luminaria)			



Materiales: Cuerpo en acero galvanizado, reflector de aluminio anodizado brillante, cristal suspendido transparente.

CODIGO	REFERENCIA	P.V.P.	Kg.	3000	3000	IP
0321053232	MAXI/DGA-320-2x32W. H.F.	130,06 €	(2,7)	6.24	6.24	20
0321053326	MAXI/DGA-320-3x26W. H.F.	161,78 €	(2,9)			
0321053332	MAXI/DGA-320-3x32W. H.F.	161,78 €	(2,9)			

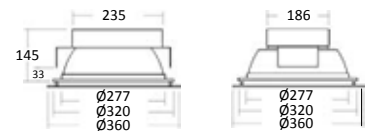
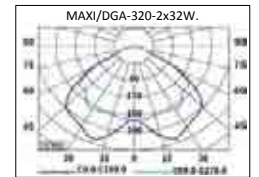

Materiales: Cuerpo en acero galvanizado, reflector de aluminio anodizado brillante, cristal suspendido transparente.

CODIGO	REFERENCIA	P.V.P.	Kg.	3000	3000	IP
03210532321	MAXI/DGA-190-320-2x32W. H.F.	130,06 €	(2,7)	6.24	6.24	20
03210533261	MAXI/DGA-190-320-3x26W. H.F.	161,78 €	(2,9)			
03210533321	MAXI/DGA-190-320-3x32W. H.F.	161,78 €	(2,9)			

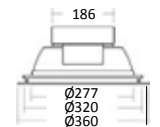
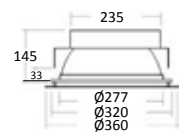
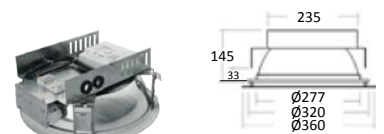

Materiales: Cuerpo en acero galvanizado, reflector de aluminio anodizado brillante, cristal suspendido mate.

CODIGO	REFERENCIA	P.V.P.	Kg.	3000	3000	IP
03210532321	MAXI/DGA-200-320-2x32W. H.F.	130,06 €	(2,7)	6.24	6.24	20
03210533261	MAXI/DGA-200-320-3x26W. H.F.	161,78 €	(2,9)			
03210533321	MAXI/DGA-200-320-3x32W. H.F.	161,78 €	(2,9)			

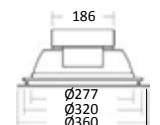
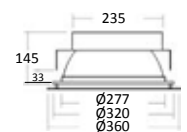
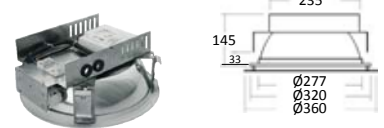

DOWNLIGHTS EMPOTRABLES COMPACTOS

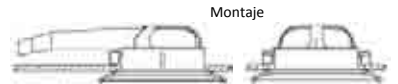

Materiales: Cuerpo en policarbonato, marco de aluminio, reflector de aluminio anodizado brillante.

CODIGO	REFERENCIA	P.V.P.	Kg.
03213003113	DLUX-1x13W. (TC-DEL) H.F.	95,85 €	(1,3)
03213003118	DLUX-1x18W. (TC-DEL) H.F.	95,85 €	(1,3)
03213103113	DLUX-1x13W. (TC-TEL) H.F.	95,85 €	(1,3)
03213103118	DLUX-1x18W. (TC-TEL) H.F.	95,85 €	(1,3)
03213103126	DLUX-1x26W. (TC-TEL) H.F.	95,85 €	(1,3)
03213103132	DLUX-1x32W. (TC-TEL) H.F.	95,85 €	(1,3)
03213003213	DLUX-2x13W. (TC-DEL) H.F.	100,51 €	(1,3)
03213003218	DLUX-2x18W. (TC-DEL) H.F.	100,51 €	(1,3)
03213103213	DLUX-2x13W. (TC-TEL) H.F.	100,51 €	(1,3)
03213103218	DLUX-2x18W. (TC-TEL) H.F.	100,51 €	(1,3)
03213103226	DLUX-2x26W. (TC-TEL) H.F.	100,51 €	(1,3)

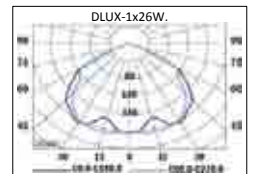

LOR= 61.31%

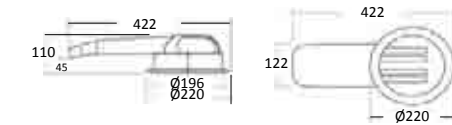

Materiales: Cuerpo en policarbonato, marco de aluminio, reflector de aluminio anodizado facetado brillante.

CODIGO	REFERENCIA	P.V.P.	Kg.
03213003131	DLUX/F-1x13W. (TC-DEL) H.F.	95,85 €	(1,3)
03213003181	DLUX/F-1x18W. (TC-DEL) H.F.	95,85 €	(1,3)
03213103131	DLUX/F-1x13W. (TC-TEL) H.F.	95,85 €	(1,3)
03213103181	DLUX/F-1x18W. (TC-TEL) H.F.	95,85 €	(1,3)
03213103126	DLUX/F-1x26W. (TC-TEL) H.F.	95,85 €	(1,3)
03213103132	DLUX/F-1x32W. (TC-TEL) H.F.	95,85 €	(1,3)
03213003213	DLUX/F-2x13W. (TC-DEL) H.F.	100,51 €	(1,3)
03213003218	DLUX/F-2x18W. (TC-DEL) H.F.	100,51 €	(1,3)
03213103213	DLUX/F-2x13W. (TC-TEL) H.F.	100,51 €	(1,3)
03213103218	DLUX/F-2x18W. (TC-TEL) H.F.	100,51 €	(1,3)
03213103226	DLUX/F-2x26W. (TC-TEL) H.F.	100,51 €	(1,3)

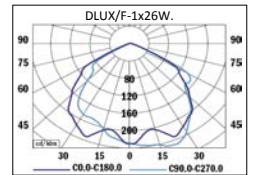

LOR= 68.97%

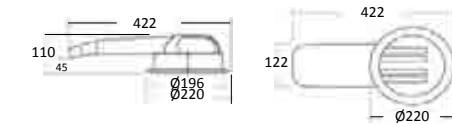

Materiales: Cuerpo en policarbonato, marco de aluminio, reflector de aluminio anodizado brillante, cristal opal.

CODIGO	REFERENCIA	P.V.P.	Kg.
03213063131	DLUX/OPAL/IP44-1x13W. (TC-DEL)	115,28 €	(1,5)
03213063181	DLUX/OPAL/IP44-1x18W. (TC-DEL)	115,28 €	(1,5)
03213163131	DLUX/OPAL/IP44-1x13W. (TC-TEL)	115,28 €	(1,5)
03213163181	DLUX/OPAL/IP44-1x18W. (TC-TEL)	115,28 €	(1,5)
03213163126	DLUX/OPAL/IP44-1x26W. (TC-TEL)	115,28 €	(1,5)
03213163132	DLUX/OPAL/IP44-1x32W. (TC-TEL)	115,28 €	(1,5)
03213063213	DLUX/OPAL/IP44-2x13W. (TC-DEL)	121,63 €	(1,5)
03213063218	DLUX/OPAL/IP44-2x18W. (TC-DEL)	121,63 €	(1,5)
03213163213	DLUX/OPAL/IP44-2x13W. (TC-TEL)	121,63 €	(1,5)
03213163218	DLUX/OPAL/IP44-2x18W. (TC-TEL)	121,63 €	(1,5)
03213163226	DLUX/OPAL/IP44-2x26W. (TC-TEL)	121,63 €	(1,5)

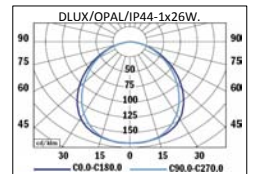

LOR= 43.18%

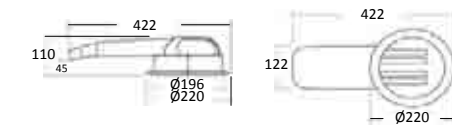

Materiales: Cuerpo en policarbonato, marco de aluminio, reflector de aluminio anodizado brillante, cristal transparente.

CODIGO	REFERENCIA	P.V.P.	Kg.
03213073113	DLUXT/IP44-1x13W. (TC-DEL) H.F.	111,38 €	(1,5)
03213073118	DLUXT/IP44-1x18W. (TC-DEL) H.F.	111,38 €	(1,5)
03213173113	DLUXT/IP44-1x13W. (TC-TEL) H.F.	111,38 €	(1,5)
03213173118	DLUXT/IP44-1x18W. (TC-TEL) H.F.	111,38 €	(1,5)
03213173126	DLUXT/IP44-1x26W. (TC-TEL) H.F.	111,38 €	(1,5)
03213173132	DLUXT/IP44-1x32W. (TC-TEL) H.F.	111,38 €	(1,5)
03213073213	DLUXT/IP44-2x13W. (TC-DEL) H.F.	119,50 €	(1,5)
03213073218	DLUXT/IP44-2x18W. (TC-DEL) H.F.	119,50 €	(1,5)
03213173213	DLUXT/IP44-2x13W. (TC-TEL) H.F.	119,50 €	(1,5)
03213173218	DLUXT/IP44-2x18W. (TC-TEL) H.F.	119,50 €	(1,5)
03213173226	DLUXT/IP44-2x26W. (TC-TEL) H.F.	119,50 €	(1,5)

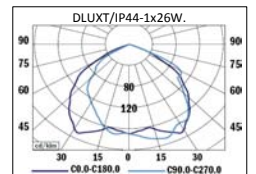

LOR= 60.81%

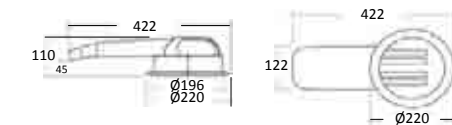

Materiales: Cuerpo en policarbonato, marco de aluminio, reflector de aluminio anodizado facetado brillante, cristal transparente.

CODIGO	REFERENCIA	P.V.P.	Kg.
03213073131	DLUXT/F/IP44-1x13W. (TC-DEL) H.F.	111,38 €	(1,5)
03213073181	DLUXT/F/IP44-1x18W. (TC-DEL) H.F.	111,38 €	(1,5)
03213173131	DLUXT/F/IP44-1x13W. (TC-TEL) H.F.	111,38 €	(1,5)
03213173181	DLUXT/F/IP44-1x18W. (TC-TEL) H.F.	111,38 €	(1,5)
03213173126	DLUXT/F/IP44-1x26W. (TC-TEL) H.F.	111,38 €	(1,5)
03213173132	DLUXT/F/IP44-1x32W. (TC-TEL) H.F.	111,38 €	(1,5)
03213073213	DLUXT/F/IP44-2x13W. (TC-DEL) H.F.	119,50 €	(1,5)
03213073218	DLUXT/F/IP44-2x18W. (TC-DEL) H.F.	119,50 €	(1,5)
03213173213	DLUXT/F/IP44-2x13W. (TC-TEL) H.F.	119,50 €	(1,5)
03213173218	DLUXT/F/IP44-2x18W. (TC-TEL) H.F.	119,50 €	(1,5)
03213173226	DLUXT/F/IP44-2x26W. (TC-TEL) H.F.	119,50 €	(1,5)



LOR= 60.81%

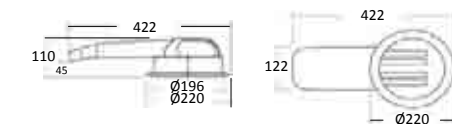

Materiales: Cuerpo en policarbonato, marco de aluminio, reflector de aluminio anodizado brillante, cristal decorativo suspendido.

CODIGO	REFERENCIA	P.V.P.	Kg.
03213013113	DGLUX-1x13W. (TC-DEL) H.F.	110,43 €	(1,5)
03213013118	DGLUX-1x18W. (TC-DEL) H.F.	110,43 €	(1,5)
03213113113	DGLUX-1x13W. (TC-TEL) H.F.	110,43 €	(1,5)
03213113118	DGLUX-1x18W. (TC-TEL) H.F.	110,43 €	(1,5)
03213113126	DGLUX-1x26W. (TC-TEL) H.F.	110,43 €	(1,5)
03213113132	DGLUX-1x32W. (TC-TEL) H.F.	110,43 €	(1,5)
03213013213	DGLUX-2x13W. (TC-DEL) H.F.	122,26 €	(1,5)
03213013218	DGLUX-2x18W. (TC-DEL) H.F.	122,26 €	(1,5)
03213113213	DGLUX-2x13W. (TC-TEL) H.F.	122,26 €	(1,5)
03213113218	DGLUX-2x18W. (TC-TEL) H.F.	122,26 €	(1,5)
03213113226	DGLUX-2x26W. (TC-TEL) H.F.	122,26 €	(1,5)

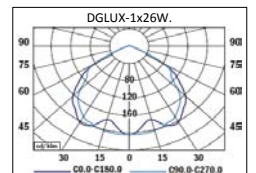

LOR= 61.31%



(Ver accesorios en la página 29)

DOWNLIGHTS EMPOTRABLES COMPACTOS



Materiales: Cuerpo en policarbonato, marco de aluminio, reflector de aluminio anodizado facetado brillante, cristal transparente.

CODIGO	REFERENCIA	P.V.P.	Kg.
032130131131	DGLUX/F-1x13W. (TC-DEL) H.F.	110,43 €	(1,5)
032130131181	DGLUX/F-1x18W. (TC-DEL) H.F.	110,43 €	(1,5)
032131131131	DGLUX/F-1x13W. (TC-TEL) H.F.	110,43 €	(1,5)
032131131181	DGLUX/F-1x18W. (TC-TEL) H.F.	110,43 €	(1,5)
032131131261	DGLUX/F-1x26W. (TC-TEL) H.F.	110,43 €	(1,5)
032131131321	DGLUX/F-1x32W. (TC-TEL) H.F.	110,43 €	(1,5)
032130132131	DGLUX/F-2x13W. (TC-DEL) H.F.	122,26 €	(1,5)
032130132181	DGLUX/F-2x18W. (TC-DEL) H.F.	122,26 €	(1,5)
032131132131	DGLUX/F-2x13W. (TC-TEL) H.F.	122,26 €	(1,5)
032131132181	DGLUX/F-2x18W. (TC-TEL) H.F.	122,26 €	(1,5)
032131132261	DGLUX/F-2x26W. (TC-TEL) H.F.	122,26 €	(1,5)

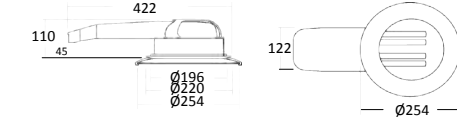
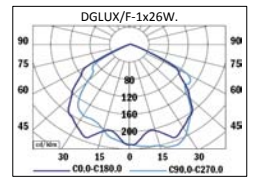

Materiales: Cuerpo en policarbonato, marco de aluminio, reflector de aluminio satinado mate.

CODIGO	REFERENCIA	P.V.P.	Kg.
03213272035	DLUX-IP44-G12 35W. HIT 230V. A.F.	130,25 €	(2,6)
03213272070	DLUX-IP44-G12 70W. HIT 230V. A.F.	130,25 €	(2,6)
03213272150	DLUX-IP44-G12 150W. HIT 230 V. A.F.	147,75 €	(3,7)
03213273035	DLUX-IP44-G12 35W. HIT H.F.	274,81 €	(1,5)
03213273070	DLUX-IP44-G12 70W. HIT H.F.	274,81 €	(1,5)
03213273150	DLUX-IP44-G12 150W. HIT H.F.	347,59 €	(1,5)
03213272035G	DLUX/GRIS-IP44-G12 35W. HIT 230V. A.F.	148,45 €	(2,6)
03213272070G	DLUX/GRIS-IP44-G12 70W. HIT 230V. A.F.	148,45 €	(2,6)
03213272150G	DLUX/GRIS-IP44-G12 150W. HIT 230V. A.F.	165,95 €	(3,7)
03213273035G	DLUX/GRIS-IP44-G12 35W. HIT H.F.	293,01 €	(1,5)
03213273070G	DLUX/GRIS-IP44-G12 70W. HIT H.F.	293,01 €	(1,5)
03213273150G	DLUX/GRIS-IP44-G12 150W. HIT H.F.	365,78 €	(1,5)

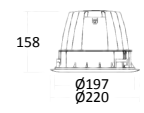
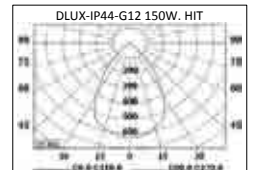

ACCESORIOS PARA MODELOS DLUX y DLUX/F (aros en color gris, bajo consulta)

CODIGO	REFERENCIA	P.V.P.	Kg.
0321300	DIFUSOR LAMA DLUX	23,52 €	-
0321301	DIFUSOR ARO DLUX	28,04 €	-
0321302	DIFUSOR CONO DLUX	63,19 €	-

Diversas posibilidades de montaje



Materiales: Cuerpo en policarbonato, marco de aluminio, reflector de aluminio anodizado brillante, cristal decorativo suspendido.

CODIGO	REFERENCIA	P.V.P.	Kg.
032130131132	DGLUX/EF-1x13W. (TC-DEL) H.F.	150,40 €	(1,7)
032130131182	DGLUX/EF-1x18W. (TC-DEL) H.F.	150,40 €	(1,7)
032131131132	DGLUX/EF-1x13W. (TC-TEL) H.F.	150,40 €	(1,7)
032131131182	DGLUX/EF-1x18W. (TC-TEL) H.F.	150,40 €	(1,7)
032131131262	DGLUX/EF-1x26W. (TC-TEL) H.F.	150,40 €	(1,7)
032131131322	DGLUX/EF-1x32W. (TC-TEL) H.F.	150,40 €	(1,7)
032130132132	DGLUX/EF-2x13W. (TC-DEL) H.F.	160,53 €	(1,8)
032130132182	DGLUX/EF-2x18W. (TC-DEL) H.F.	160,53 €	(1,8)
032131132132	DGLUX/EF-2x13W. (TC-TEL) H.F.	160,53 €	(1,8)
032131132182	DGLUX/EF-2x18W. (TC-TEL) H.F.	160,53 €	(1,8)
032131132262	DGLUX/EF-2x26W. (TC-TEL) H.F.	160,53 €	(1,8)

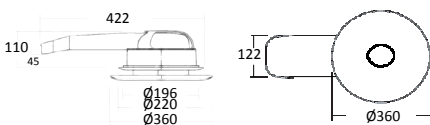

Materiales: Cuerpo en policarbonato, marco de aluminio, reflector de aluminio anodizado facetado brillante, aros decorativos suspendidos.

CODIGO	REFERENCIA	P.V.P.	Kg.
032130131133	DGLUX/TRIO-1x13W. (TC-DEL) H.F.	137,79 €	(2,3)
032130131183	DGLUX/TRIO-1x18W. (TC-DEL) H.F.	137,79 €	(2,3)
032131131133	DGLUX/TRIO-1x13W. (TC-TEL) H.F.	137,79 €	(2,3)
032131131183	DGLUX/TRIO-1x18W. (TC-TEL) H.F.	137,79 €	(2,3)
032131131263	DGLUX/TRIO-1x26W. (TC-TEL) H.F.	137,79 €	(2,3)
032131131323	DGLUX/TRIO-1x32W. (TC-TEL) H.F.	137,79 €	(2,3)
032130132133	DGLUX/TRIO-2x13W. (TC-DEL) H.F.	149,18 €	(2,4)
032130132183	DGLUX/TRIO-2x18W. (TC-DEL) H.F.	149,18 €	(2,4)
032131132133	DGLUX/TRIO-2x13W. (TC-TEL) H.F.	149,18 €	(2,4)
032131132183	DGLUX/TRIO-2x18W. (TC-TEL) H.F.	149,18 €	(2,4)
032131132263	DGLUX/TRIO-2x26W. (TC-TEL) H.F.	149,18 €	(2,4)

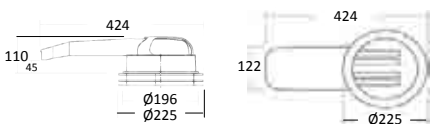

DOWNLIGHTS EMPOTRABLES DESCARGA

Materiales: Cuerpo en acero galvanizado, reflector de aluminio anodizado mate.

CODIGO	REFERENCIA	P.V.P.	Kg.
0321500170	CRT-70W. HIT-DE 230V.	65,19 €	(3,0)
03215001150	CRT-150W. HIT-DE 230V.	82,69 €	(3,9)
0321500170L	CRT-70W. HIT-DE 230V. + LAMP.	88,17 €	(3,1)
03215001150L	CRT-150W. HIT-DE 230V. + LAMP.	105,67 €	(4,0)

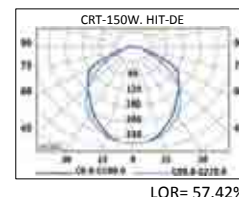
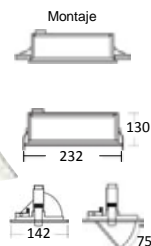
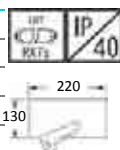

Materiales: Cuerpo en acero galvanizado, reflector de aluminio anodizado brillante.

CODIGO	REFERENCIA	P.V.P.	Kg.
0321000070	DTM-IP44-70W. HIT-DE 230V.	88,97 €	(2,5)
0321000150	DTM-IP44-150W. HIT-DE 230V.	106,77 €	(3,8)
0321000070L	DTM-IP44-70W. HIT-DE 230V. + LAMP.	111,95 €	(2,6)
0321000150L	DTM-IP44-150W. HIT-DE 230V. + LAMP.	129,75 €	(3,9)
0321000070G	DTM/GRIS-IP44-70W. HIT-DE 230V.	107,16 €	(2,5)
0321000150G	DTM/GRIS-IP44-150W. HIT-DE 230V.	124,97 €	(3,8)
0321000070GL	DTM/GRIS-IP44-70W. HIT-DE 230V. + LAMP.	130,14 €	(2,6)
0321000150GL	DTM/GRIS-IP44-150W. HIT-DE 230V. + LAMP.	147,95 €	(3,9)
03210000701	DTM-IP44-G12-70W. HIT-DE 230V.	91,48 €	(2,5)
03210001501	DTM-IP44-G12-150W. HIT-DE 230V.	108,98 €	(3,8)
03210000701G	DTM/GRIS-IP44-G12-70W. HIT-DE 230V.	109,68 €	(2,5)
03210001501G	DTM/GRIS-IP44-G12-150W. HIT-DE 230V.	127,18 €	(3,8)

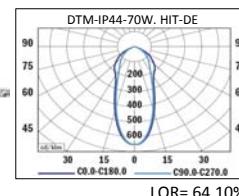
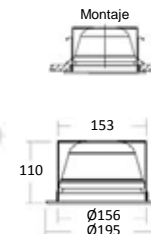

Materiales: Cuerpo en acero galvanizado, reflector de aluminio, cristal satinado.

CODIGO	REFERENCIA	P.V.P.	Kg.
0411045070	RXH-G12 70W. HIT 230V.	125,46 €	(3,8)
0411045150	RXH-G12 150W. HIT 230V.	148,21 €	(5,1)

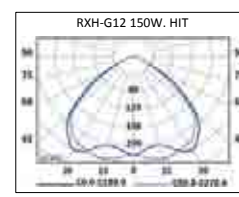
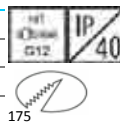

Materiales: Cuerpo en acero galvanizado, reflector de aluminio, cristal satinado.

CODIGO	REFERENCIA	P.V.P.	Kg.
0411001070	RXH-RX7S 70W. HIT-DE 230V.	143,59 €	(3,8)
0411001150	RXH-RX7S 150W. HIT-DE 230V.	166,34 €	(5,1)
0411001070L	RXH-RX7S 70W. HIT-DE 230V. + LAMP.	166,57 €	(3,9)
0411001150L	RXH-RX7S 150W. HIT-DE 230V. + LAMP.	189,32 €	(5,2)

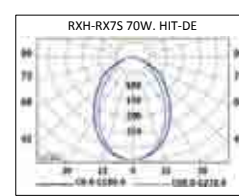
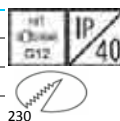

DOWNLIGHTS EMPOTRABLES

Materiales: Marco en chapa de acero pintado en color blanco, reflector de policarbonato metalizado, cristal serigrafiado.

CODIGO	REFERENCIA	P.V.P.	Kg.
0322412113	DEBP-1x13 230V. A.F.	37,41 €	(1,4)
0322412118	DEBP-1x18 230V. A.F.	37,41 €	(1,4)
0322412126	DEBP-1x26 230V. A.F.	37,41 €	(1,4)
0322412213	DEBP-2x13 230V. A.F.	38,33 €	(2,1)
0322412218	DEBP-2x18 230V. A.F.	38,33 €	(2,1)
0322412226	DEBP-2x26 230V. A.F.	38,33 €	(2,1)
0322413113	DEBP-1x13 230V. H.F.	60,76 €	(1,0)
0322413118	DEBP-1x18 230V. H.F.	60,76 €	(1,0)
0322413126	DEBP-1x26 230V. H.F.	60,76 €	(1,0)
0322413213	DEBP-2x13 230V. H.F.	61,52 €	(1,1)
0322413218	DEBP-2x18 230V. H.F.	61,52 €	(1,1)
0322413226	DEBP-2x26 230V. H.F.	61,52 €	(1,1)

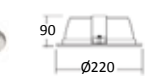
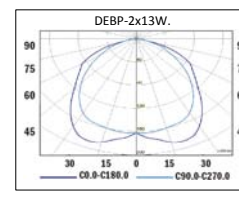
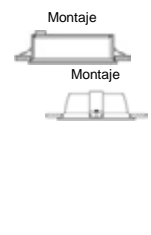
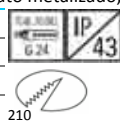

DOWNLIGHTS EMPOTRABLES

Materiales: Marco curvado en chapa de acero en color níquel, reflector de policarbonato metalizado, cristal serigrafado.

CODIGO	REFERENCIA	P.V.P.	Kg.
032432113	DENP-1x13 230V. A.F.	42,31 €	(1,4)
032432118	DENP-1x18 230V. A.F.	42,31 €	(1,4)
032432126	DENP-1x26 230V. A.F.	42,31 €	(1,4)
032432213	DENP-2x13 230V. A.F.	43,27 €	(2,1)
032432218	DENP-2x18 230V. A.F.	43,27 €	(2,1)
032432226	DENP-2x26 230V. A.F.	43,27 €	(2,1)
032433113	DENP-1x13 230V. H.F.	64,99 €	(1,0)
032433118	DENP-1x18 230V. H.F.	64,99 €	(1,0)
032433126	DENP-1x26 230V. H.F.	64,99 €	(1,0)
032433213	DENP-2x13 230V. H.F.	70,50 €	(1,1)
032433218	DENP-2x18 230V. H.F.	70,50 €	(1,1)
032433226	DENP-2x26 230V. H.F.	70,50 €	(1,1)

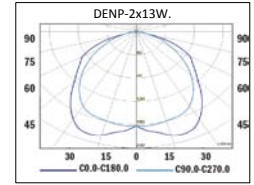
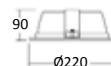

LOR= 49.75%

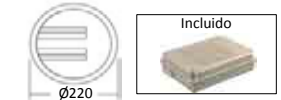

Incluido

DOWNLIGHTS CUADRADOS EMPOTRABLES

Materiales: Cuerpo en acero galvanizado, reflector de aluminio anodizado brillante, cristal transparente con cuadrado central mateado.

CODIGO	REFERENCIA	P.V.P.	Kg.
032442113	DECO/BL-1x13 230V. A.F.	76,44 €	(2,6)
032442118	DECO/BL-1x18 230V. A.F.	76,44 €	(2,6)
032442126	DECO/BL-1x26 230V. A.F.	76,44 €	(2,6)
032442213	DECO/BL-2x13 230V. A.F.	86,13 €	(3,2)
032442218	DECO/BL-2x18 230V. A.F.	86,13 €	(3,2)
032442226	DECO/BL-2x26 230V. A.F.	86,13 €	(3,2)
032443113	DECO/BL-1x13 230V. H.F.	92,77 €	(2,2)
032443118	DECO/BL-1x18 230V. H.F.	92,77 €	(2,2)
032443126	DECO/BL-1x26 230V. H.F.	92,77 €	(2,2)
032443213	DECO/BL-2x13 230V. H.F.	101,85 €	(2,3)
032443218	DECO/BL-2x18 230V. H.F.	101,85 €	(2,3)
032443226	DECO/BL-2x26 230V. H.F.	101,85 €	(2,3)

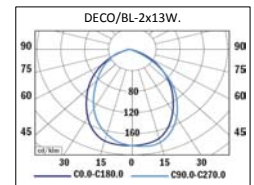
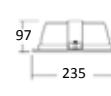
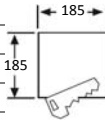

LOR= 56.11%

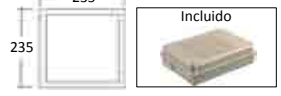

Incluido

032442113N	DECO/NE-1x13 230V. A.F.	76,44 €	(2,6)
032442118N	DECO/NE-1x18 230V. A.F.	76,44 €	(2,6)
032442126N	DECO/NE-1x26 230V. A.F.	76,44 €	(2,6)
032442213N	DECO/NE-2x13 230V. A.F.	86,13 €	(3,2)
032442218N	DECO/NE-2x18 230V. A.F.	86,13 €	(3,2)
032442226N	DECO/NE-2x26 230V. A.F.	86,13 €	(3,2)
032443113N	DECO/NE-1x13 230V. H.F.	92,77 €	(2,2)
032443118N	DECO/NE-1x18 230V. H.F.	92,77 €	(2,2)
032443126N	DECO/NE-1x26 230V. H.F.	92,77 €	(2,2)
032443213N	DECO/NE-2x13 230V. H.F.	101,85 €	(2,3)
032443218N	DECO/NE-2x18 230V. H.F.	101,85 €	(2,3)
032443226N	DECO/NE-2x26 230V. H.F.	101,85 €	(2,3)

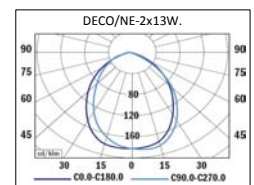
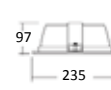
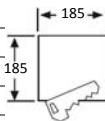

LOR= 56.11%



Incluido

032442113G	DECO/GR-1x13 230V. A.F.	76,44 €	(2,6)
032442118G	DECO/GR-1x18 230V. A.F.	76,44 €	(2,6)
032442126G	DECO/GR-1x26 230V. A.F.	76,44 €	(2,6)
032442213G	DECO/GR-2x13 230V. A.F.	86,13 €	(3,2)
032442218G	DECO/GR-2x18 230V. A.F.	86,13 €	(3,2)
032442226G	DECO/GR-2x26 230V. A.F.	86,13 €	(3,2)
032443113G	DECO/GR-1x13 230V. H.F.	92,77 €	(2,2)
032443118G	DECO/GR-1x18 230V. H.F.	92,77 €	(2,2)
032443126G	DECO/GR-1x26 230V. H.F.	92,77 €	(2,2)
032443213G	DECO/GR-2x13 230V. H.F.	101,85 €	(2,3)
032443218G	DECO/GR-2x18 230V. H.F.	101,85 €	(2,3)
032443226G	DECO/GR-2x26 230V. H.F.	101,85 €	(2,3)

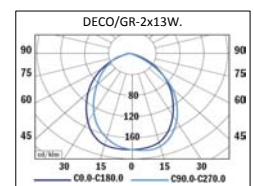
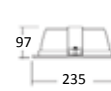
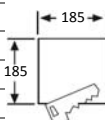

LOR= 56.11%



Incluido

DOWNLIGHTS CUADRADOS EMPOTRABLES

Materiales: Cuerpo en acero galvanizado, reflector de aluminio anodizado brillante.

CODIGO	REFERENCIA	P.V.P.	Kg.
032522113	LUXUS-243/A-1x13W. 230V. A.F. (TC-D)	80,57 €	(2,1)
032522118	LUXUS-243/A-1x18W. 230V. A.F. (TC-D)	80,57 €	(2,2)
032522126	LUXUS-243/A-1x26W. 230V. A.F. (TC-D)	80,57 €	(2,3)
032522213	LUXUS-243/A-2x13W. 230V. A.F. (TC-D)	90,23 €	(2,5)
032522218	LUXUS-243/A-2x18W. 230V. A.F. (TC-D)	90,23 €	(2,7)
032522226	LUXUS-243/A-2x26W. 230V. A.F. (TC-D)	90,23 €	(2,9)
032523113	LUXUS-243/A-1x13W. H.F. (TC-DEL)	115,36 €	(2,0)
032523118	LUXUS-243/A-1x18W. H.F. (TC-DEL)	115,36 €	(2,0)
032523126	LUXUS-243/A-1x26W. H.F. (TC-DEL)	115,36 €	(2,0)
032523213	LUXUS-243/A-2x13W. H.F. (TC-DEL)	119,48 €	(2,1)
032523218	LUXUS-243/A-2x18W. H.F. (TC-DEL)	119,48 €	(2,1)
032523226	LUXUS-243/A-2x26W. H.F. (TC-DEL)	119,48 €	(2,1)

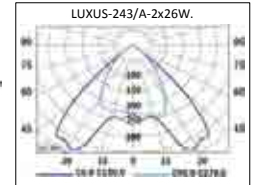
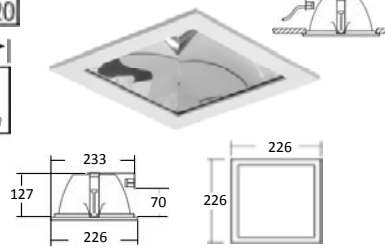
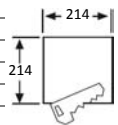

LOR= 56.11%

032512113	LUXUS-269/A-1x13W. 230V. A.F. (TC-D)	84,21 €	(2,3)
032512118	LUXUS-269/A-1x18W. 230V. A.F. (TC-D)	84,21 €	(2,4)
032512126	LUXUS-269/A-1x26W. 230V. A.F. (TC-D)	84,21 €	(2,5)
032512213	LUXUS-269/A-2x13W. 230V. A.F. (TC-D)	93,96 €	(2,7)
032512218	LUXUS-269/A-2x18W. 230V. A.F. (TC-D)	93,96 €	(2,9)
032512226	LUXUS-269/A-2x26W. 230V. A.F. (TC-D)	93,96 €	(3,2)
032513113	LUXUS-269/A-1x13W. 230V. H.F. (TC-DEL)	121,20 €	(2,2)
032513118	LUXUS-269/A-1x18W. 230V. H.F. (TC-DEL)	121,20 €	(2,2)
032513126	LUXUS-269/A-1x26W. 230V. H.F. (TC-DEL)	121,20 €	(2,2)
032513132	LUXUS-269/A-1x32W. 230V. H.F. (TC-DEL)	121,20 €	(2,2)
032513142	LUXUS-269/A-1x42W. 230V. H.F. (TC-TEL)	121,20 €	(2,2)
032513213	LUXUS-269/A-2x13W. 230V. H.F. (TC-DEL)	126,32 €	(2,3)
032513218	LUXUS-269/A-2x18W. 230V. H.F. (TC-DEL)	126,32 €	(2,3)
032513226	LUXUS-269/A-2x26W. 230V. H.F. (TC-DEL)	126,32 €	(2,3)
032513232	LUXUS-269/A-2x32W. 230V. H.F. (TC-TEL)	126,32 €	(2,3)

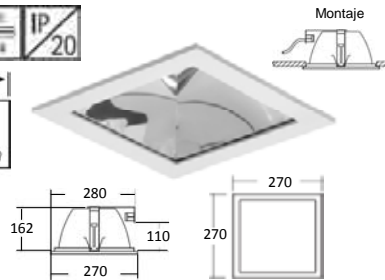
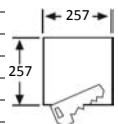
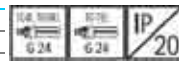

Caja porta-equipos incluida

Materiales: Cuerpo en acero galvanizado, reflector de aluminio anodizado, difusor doble parabólico brillante.

CODIGO	REFERENCIA	P.V.P.	Kg.
032542113	LUXUS-243/BR-1x13W. 230V. A.F. (TC-D)	89,58 €	(2,3)
032542118	LUXUS-243/BR-1x18W. 230V. A.F. (TC-D)	89,58 €	(2,4)
032542126	LUXUS-243/BR-1x26W. 230V. A.F. (TC-D)	89,58 €	(2,5)
032542213	LUXUS-243/BR-2x13W. 230V. A.F. (TC-D)	97,51 €	(2,7)
032542218	LUXUS-243/BR-2x18W. 230V. A.F. (TC-D)	97,51 €	(2,9)
032542226	LUXUS-243/BR-2x26W. 230V. A.F. (TC-D)	97,51 €	(3,1)
032543113	LUXUS-243/BR-1x13W. H.F. (TC-DEL)	123,12 €	(2,2)
032543118	LUXUS-243/BR-1x18W. H.F. (TC-DEL)	123,12 €	(2,2)
032543126	LUXUS-243/BR-1x26W. H.F. (TC-DEL)	123,12 €	(2,2)
032543213	LUXUS-243/BR-2x13W. H.F. (TC-DEL)	127,19 €	(2,3)
032543218	LUXUS-243/BR-2x18W. H.F. (TC-DEL)	127,19 €	(2,3)
032543226	LUXUS-243/BR-2x26W. H.F. (TC-DEL)	127,19 €	(2,3)

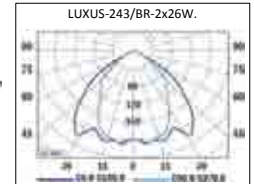
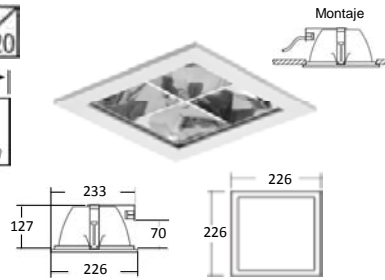
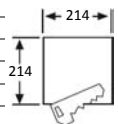

LOR= 44.42%

032532113	LUXUS-269/BR-1x13W. 230V. A.F. (TC-D)	90,84 €	(2,5)
032532118	LUXUS-269/BR-1x18W. 230V. A.F. (TC-D)	90,84 €	(2,6)
032532126	LUXUS-269/BR-1x26W. 230V. A.F. (TC-D)	90,84 €	(2,7)
032532213	LUXUS-269/BR-2x13W. 230V. A.F. (TC-D)	100,32 €	(2,9)
032532218	LUXUS-269/BR-2x18W. 230V. A.F. (TC-D)	100,32 €	(3,1)
032532226	LUXUS-269/BR-2x26W. 230V. A.F. (TC-D)	100,32 €	(3,4)
032533113	LUXUS-269/BR-1x13W. 230V. H.F. (TC-DEL)	128,05 €	(2,4)
032533118	LUXUS-269/BR-1x18W. 230V. H.F. (TC-DEL)	128,05 €	(2,4)
032533126	LUXUS-269/BR-1x26W. 230V. H.F. (TC-DEL)	128,05 €	(2,4)
032533132	LUXUS-269/BR-1x32W. 230V. H.F. (TC-TEL)	128,05 €	(2,4)
032533142	LUXUS-269/BR-1x42W. 230V. H.F. (TC-TEL)	128,05 €	(2,4)
032533213	LUXUS-269/BR-2x13W. 230V. H.F. (TC-DEL)	133,20 €	(2,5)
032533218	LUXUS-269/BR-2x18W. 230V. H.F. (TC-DEL)	133,20 €	(2,5)
032533226	LUXUS-269/BR-2x26W. 230V. H.F. (TC-DEL)	133,20 €	(2,5)
032533232	LUXUS-269/BR-2x32W. 230V. H.F. (TC-TEL)	133,20 €	(2,5)

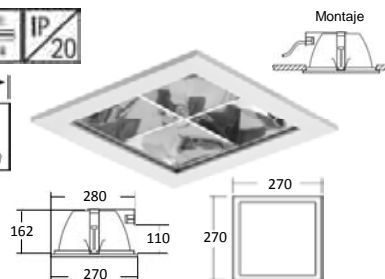
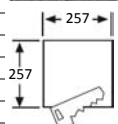
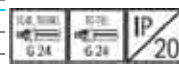

Caja porta-equipos incluida

Materiales: Cuerpo en acero galvanizado, reflector de aluminio anodizado brillante, cristal opal.

CODIGO	REFERENCIA	P.V.P.	Kg.
032592113	LUXUS-243/OPAL-1x13W. 230V. A.F. (TC-D)	112,25 €	(2,5)
032592118	LUXUS-243/OPAL-1x18W. 230V. A.F. (TC-D)	112,25 €	(2,6)
032592126	LUXUS-243/OPAL-1x26W. 230V. A.F. (TC-D)	112,25 €	(2,7)
032592213	LUXUS-243/OPAL-2x13W. 230V. A.F. (TC-D)	121,68 €	(2,9)
032592218	LUXUS-243/OPAL-2x18W. 230V. A.F. (TC-D)	121,68 €	(3,1)
032593113	LUXUS-243/OPAL-1x13W. H.F. (TC-DEL)	136,80 €	(2,4)
032593118	LUXUS-243/OPAL-1x18W. H.F. (TC-DEL)	136,80 €	(2,4)
032593126	LUXUS-243/OPAL-1x26W. H.F. (TC-DEL)	136,80 €	(2,4)
032593213	LUXUS-243/OPAL-2x13W. H.F. (TC-DEL)	141,82 €	(2,5)
032593218	LUXUS-243/OPAL-2x18W. H.F. (TC-DEL)	141,82 €	(2,5)

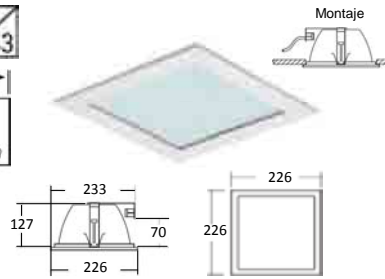
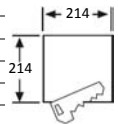
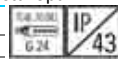

Caja porta-equipos incluida

032582113	LUXUS-269/OPAL-1x13W. 230V. A.F. (TC-D)	115,02 €	(2,7)
032582118	LUXUS-269/OPAL-1x18W. 230V. A.F. (TC-D)	115,02 €	(2,8)
032582126	LUXUS-269/OPAL-1x26W. 230V. A.F. (TC-D)	115,02 €	(2,9)
032582213	LUXUS-269/OPAL-2x13W. 230V. A.F. (TC-D)	127,32 €	(3,1)
032582218	LUXUS-269/OPAL-2x18W. 230V. A.F. (TC-D)	127,32 €	(3,3)
032582226	LUXUS-269/OPAL-2x26W. 230V. A.F. (TC-D)	127,32 €	(3,6)
032583113	LUXUS-269/OPAL-1x13W. 230V. H.F. (TC-DEL)	158,66 €	(2,6)
032583118	LUXUS-269/OPAL-1x18W. 230V. H.F. (TC-DEL)	158,66 €	(2,6)
032583126	LUXUS-269/OPAL-1x26W. 230V. H.F. (TC-DEL)	158,66 €	(2,6)
032583132	LUXUS-269/OPAL-1x32W. 230V. H.F. (TC-TEL)	158,66 €	(2,6)
032583142	LUXUS-269/OPAL-1x42W. 230V. H.F. (TC-TEL)	158,66 €	(2,6)
032583213	LUXUS-269/OPAL-2x13W. 230V. H.F. (TC-DEL)	164,34 €	(2,7)
032583218	LUXUS-269/OPAL-2x18W. 230V. H.F. (TC-DEL)	164,34 €	(2,7)
032583226	LUXUS-269/OPAL-2x26W. 230V. H.F. (TC-DEL)	164,34 €	(2,7)
032583232	LUXUS-269/OPAL-2x32W. 230V. H.F. (TC-TEL)	164,34 €	(2,7)

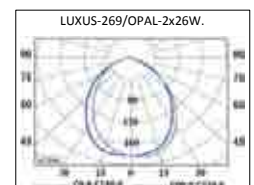
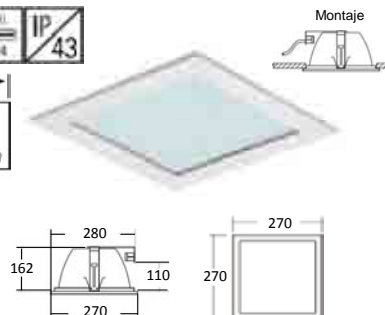
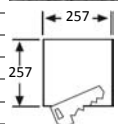
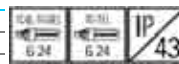

LOR= 38.34%

DOWNLIGHTS CUADRADOS EMPOTRABLES MARCO GRIS

Materiales: Cuerpo en acero galvanizado, reflector de aluminio anodizado brillante.

CODIGO	REFERENCIA	P.V.P.	Kg.
032522113G	LUXUS/GRIS-243/A-1x13W. 230V. A.F. (TC-D)	98,76 €	(2,1)
032522118G	LUXUS/GRIS-243/A-1x18W. 230V. A.F. (TC-D)	98,76 €	(2,2)
032522126G	LUXUS/GRIS-243/A-1x26W. 230V. A.F. (TC-D)	98,76 €	(2,3)
032522213G	LUXUS/GRIS-243/A-2x13W. 230V. A.F. (TC-D)	108,42 €	(2,5)
032522218G	LUXUS/GRIS-243/A-2x18W. 230V. A.F. (TC-D)	108,42 €	(2,7)
032522226G	LUXUS/GRIS-243/A-2x26W. 230V. A.F. (TC-D)	108,42 €	(2,9)
032523113G	LUXUS/GRIS-243/A-1x13W. H.F. (TC-DEL)	133,56 €	(2,0)
032523118G	LUXUS/GRIS-243/A-1x18W. H.F. (TC-DEL)	133,56 €	(2,0)
032523126G	LUXUS/GRIS-243/A-1x26W. H.F. (TC-DEL)	133,56 €	(2,0)
032523213G	LUXUS/GRIS-243/A-2x13W. H.F. (TC-DEL)	137,67 €	(2,1)
032523218G	LUXUS/GRIS-243/A-2x18W. H.F. (TC-DEL)	137,67 €	(2,1)
032523226G	LUXUS/GRIS-243/A-2x26W. H.F. (TC-DEL)	137,67 €	(2,1)

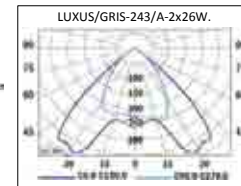
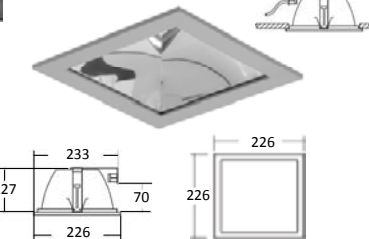
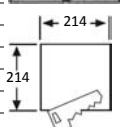

LOR= 56.11%

032512113G	LUXUS/GRIS-269/A-1x13W. 230V. A.F. (TC-D)	102,40 €	(2,3)
032512118G	LUXUS/GRIS-269/A-1x18W. 230V. A.F. (TC-D)	102,40 €	(2,4)
032512126G	LUXUS/GRIS-269/A-1x26W. 230V. A.F. (TC-D)	102,40 €	(2,5)
032512213G	LUXUS/GRIS-269/A-2x13W. 230V. A.F. (TC-D)	112,15 €	(2,7)
032512218G	LUXUS/GRIS-269/A-2x18W. 230V. A.F. (TC-D)	112,15 €	(2,9)
032512226G	LUXUS/GRIS-269/A-2x26W. 230V. A.F. (TC-D)	112,15 €	(3,2)
032513113G	LUXUS/GRIS-269/A-1x13W. 230V. H.F. (TC-DEL)	139,40 €	(2,2)
032513118G	LUXUS/GRIS-269/A-1x18W. 230V. H.F. (TC-DEL)	139,40 €	(2,2)
032513126G	LUXUS/GRIS-269/A-1x26W. 230V. H.F. (TC-DEL)	139,40 €	(2,2)
032513132G	LUXUS/GRIS-269/A-1x32W. 230V. H.F. (TC-TEL)	139,40 €	(2,2)
032513142G	LUXUS/GRIS-269/A-1x42W. 230V. H.F. (TC-TEL)	139,40 €	(2,2)
032513213G	LUXUS/GRIS-269/A-2x13W. 230V. H.F. (TC-DEL)	144,51 €	(2,3)
032513218G	LUXUS/GRIS-269/A-2x18W. 230V. H.F. (TC-DEL)	144,51 €	(2,3)
032513226G	LUXUS/GRIS-269/A-2x26W. 230V. H.F. (TC-DEL)	144,51 €	(2,3)
032513232G	LUXUS/GRIS-269/A-2x32W. 230V. H.F. (TC-TEL)	144,51 €	(2,3)

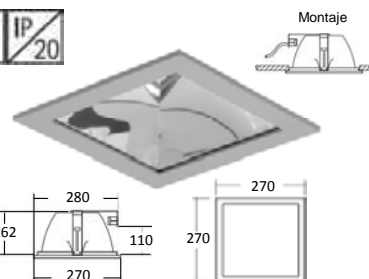
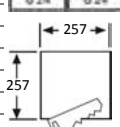

Caja porta-equipos incluida

Materiales: Cuerpo en acero galvanizado, reflector de aluminio anodizado, difusor doble parabólico brillante.

CODIGO	REFERENCIA	P.V.P.	Kg.
032542113G	LUXUS/GRIS-243/BR-1x13W. 230V. A.F. (TC-D)	107,77 €	(2,3)
032542118G	LUXUS/GRIS-243/BR-1x18W. 230V. A.F. (TC-D)	107,77 €	(2,4)
032542126G	LUXUS/GRIS-243/BR-1x26W. 230V. A.F. (TC-D)	107,77 €	(2,5)
032542213G	LUXUS/GRIS-243/BR-2x13W. 230V. A.F. (TC-D)	115,70 €	(2,7)
032542218G	LUXUS/GRIS-243/BR-2x18W. 230V. A.F. (TC-D)	115,70 €	(2,9)
032542226G	LUXUS/GRIS-243/BR-2x26W. 230V. A.F. (TC-D)	115,70 €	(3,1)
032543113G	LUXUS/GRIS-243/BR-1x13W. H.F. (TC-DEL)	141,31 €	(2,2)
032543118G	LUXUS/GRIS-243/BR-1x18W. H.F. (TC-DEL)	141,31 €	(2,2)
032543126G	LUXUS/GRIS-243/BR-1x26W. H.F. (TC-DEL)	141,31 €	(2,2)
032543213G	LUXUS/GRIS-243/BR-2x13W. H.F. (TC-DEL)	145,38 €	(2,3)
032543218G	LUXUS/GRIS-243/BR-2x18W. H.F. (TC-DEL)	145,38 €	(2,3)
032543226G	LUXUS/GRIS-243/BR-2x26W. H.F. (TC-DEL)	145,38 €	(2,3)

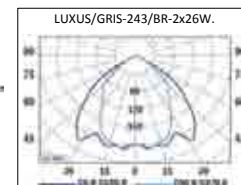
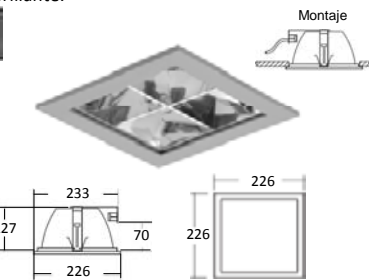
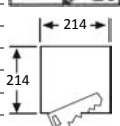

LOR= 44.42%

032532113G	LUXUS/GRIS-269/BR-1x13W. 230V. A.F. (TC-D)	109,91 €	(2,5)
032532118G	LUXUS/GRIS-269/BR-1x18W. 230V. A.F. (TC-D)	109,91 €	(2,6)
032532126G	LUXUS/GRIS-269/BR-1x26W. 230V. A.F. (TC-D)	109,91 €	(2,7)
032532213G	LUXUS/GRIS-269/BR-2x13W. 230V. A.F. (TC-D)	118,52 €	(2,9)
032532218G	LUXUS/GRIS-269/BR-2x18W. 230V. A.F. (TC-D)	118,52 €	(3,1)
032532226G	LUXUS/GRIS-269/BR-2x26W. 230V. A.F. (TC-D)	118,52 €	(3,4)
032533113G	LUXUS/GRIS-269/BR-1x13W. 230V. H.F. (TC-DEL)	146,24 €	(2,4)
032533118G	LUXUS/GRIS-269/BR-1x18W. 230V. H.F. (TC-DEL)	146,24 €	(2,4)
032533126G	LUXUS/GRIS-269/BR-1x26W. 230V. H.F. (TC-DEL)	146,24 €	(2,4)
032533132G	LUXUS/GRIS-269/BR-1x32W. 230V. H.F. (TC-TEL)	146,24 €	(2,4)
032533142G	LUXUS/GRIS-269/BR-1x42W. 230V. H.F. (TC-TEL)	146,24 €	(2,4)
032533213G	LUXUS/GRIS-269/BR-2x13W. 230V. H.F. (TC-DEL)	151,40 €	(2,5)
032533218G	LUXUS/GRIS-269/BR-2x18W. 230V. H.F. (TC-DEL)	151,40 €	(2,5)
032533226G	LUXUS/GRIS-269/BR-2x26W. 230V. H.F. (TC-DEL)	151,40 €	(2,5)
032533232G	LUXUS/GRIS-269/BR-2x32W. 230V. H.F. (TC-TEL)	151,40 €	(2,5)

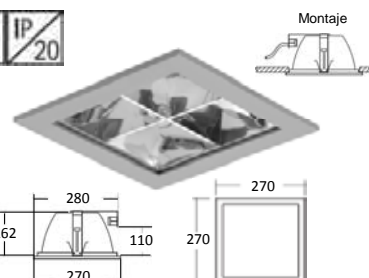
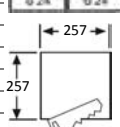

Caja porta-equipos incluida

Materiales: Cuerpo en acero galvanizado, reflector de aluminio anodizado brillante, cristal opal.

CODIGO	REFERENCIA	P.V.P.	Kg.
032592113G	LUXUS/GRIS-243/OPAL-1x13W. 230V. A.F. (TC-D)	131,96 €	(2,5)
032592118G	LUXUS/GRIS-243/OPAL-1x18W. 230V. A.F. (TC-D)	131,96 €	(2,6)
032592126G	LUXUS/GRIS-243/OPAL-1x26W. 230V. A.F. (TC-D)	131,96 €	(2,7)
032592213G	LUXUS/GRIS-243/OPAL-2x13W. 230V. A.F. (TC-D)	141,39 €	(2,9)
032592218G	LUXUS/GRIS-243/OPAL-2x18W. 230V. A.F. (TC-D)	141,39 €	(3,1)
032593113G	LUXUS/GRIS-243/OPAL-1x13W. H.F. (TC-DEL)	156,51 €	(2,4)
032593118G	LUXUS/GRIS-243/OPAL-1x18W. H.F. (TC-DEL)	156,51 €	(2,4)
032593126G	LUXUS/GRIS-243/OPAL-1x26W. H.F. (TC-DEL)	156,51 €	(2,4)
032593213G	LUXUS/GRIS-243/OPAL-2x13W. H.F. (TC-DEL)	161,53 €	(2,5)
032593218G	LUXUS/GRIS-243/OPAL-2x18W. H.F. (TC-DEL)	161,53 €	(2,5)

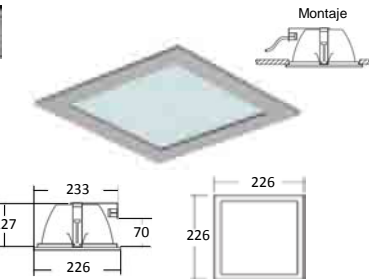
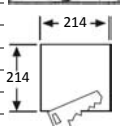

Caja porta-equipos incluida

032582113G	LUXUS/GRIS-269/OPAL-1x13W. 230V. A.F. (TC-D)	134,73 €	(2,7)
032582118G	LUXUS/GRIS-269/OPAL-1x18W. 230V. A.F. (TC-D)	134,73 €	(2,8)
032582126G	LUXUS/GRIS-269/OPAL-1x26W. 230V. A.F. (TC-D)	134,73 €	(2,9)
032582213G	LUXUS/GRIS-269/OPAL-2x13W. 230V. A.F. (TC-D)	147,03 €	(3,1)
032582218G	LUXUS/GRIS-269/OPAL-2x18W. 230V. A.F. (TC-D)	147,03 €	(3,3)
032582226G	LUXUS/GRIS-269/OPAL-2x26W. 230V. A.F. (TC-D)	147,03 €	(3,6)
032583113G	LUXUS/GRIS-269/OPAL-1x13W. 230V. H.F. (TC-DEL)	178,37 €	(2,6)
032583118G	LUXUS/GRIS-269/OPAL-1x18W. 230V. H.F. (TC-DEL)	178,37 €	(2,6)
032583126G	LUXUS/GRIS-269/OPAL-1x26W. 230V. H.F. (TC-DEL)	178,37 €	(2,6)
032583132G	LUXUS/GRIS-269/OPAL-1x32W. 230V. H.F. (TC-TEL)	178,37 €	(2,6)
032583142G	LUXUS/GRIS-269/OPAL-1x42W. 230V. H.F. (TC-TEL)	178,37 €	(2,6)
032583213G	LUXUS/GRIS-269/OPAL-2x13W. 230V. H.F. (TC-DEL)	184,05 €	(2,7)
032583218G	LUXUS/GRIS-269/OPAL-2x18W. 230V. H.F. (TC-DEL)	184,05 €	(2,7)
032583226G	LUXUS/GRIS-269/OPAL-2x26W. 230V. H.F. (TC-DEL)	184,05 €	(2,7)
032583232G	LUXUS/GRIS-269/OPAL-2x32W. 230V. H.F. (TC-TEL)	184,05 €	(2,7)

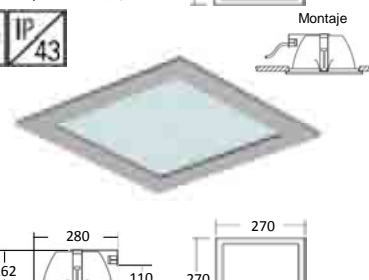
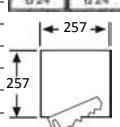

LOR= 38.34%

DOWNLIGHTS EMPOTRABLES

Materiales: Cuerpo en acero galvanizado, reflector de aluminio anodizado brillante, cristal tronco-cónico de color con embellecedor metálico.

CODIGO	REFERENCIA	P.V.P.	Kg.
032150042118	DAX/B-1x18W. 230V. A.F.	86,80 €	(2,3)
032150042126	DAX/B-1x26W. 230V. A.F.	86,80 €	(2,4)
032150042218	DAX/B-2x18W. 230V. A.F.	95,32 €	(2,3)
032150042226	DAX/B-2x26W. 230V. A.F.	95,32 €	(2,4)
032150043118	DAX/B-1x18W. H.F.	117,51 €	(1,3)
032150043126	DAX/B-1x26W. H.F.	117,51 €	(1,3)
032150043132	DAX/B-1x32W. H.F.	117,51 €	(1,3)
032150043142	DAX/B-1x42W. H.F.	117,51 €	(1,3)
032150043218	DAX/B-2x18W. H.F.	122,87 €	(1,5)
032150043226	DAX/B-2x26W. H.F.	122,87 €	(1,5)
032150043232	DAX/B-2x32W. H.F.	122,87 €	(1,5)

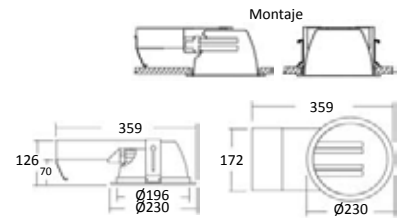

032150052118	DAX/OR-1x18W. 230V. A.F.	86,80 €	(2,3)
032150052126	DAX/OR-1x26W. 230V. A.F.	86,80 €	(2,4)
032150052218	DAX/OR-2x18W. 230V. A.F.	95,32 €	(2,3)
032150052226	DAX/OR-2x26W. 230V. A.F.	95,32 €	(2,4)
032150053118	DAX/OR-1x18W. H.F.	117,51 €	(1,3)
032150053126	DAX/OR-1x26W. H.F.	117,51 €	(1,3)
032150053132	DAX/OR-1x32W. H.F.	117,51 €	(1,3)
032150053142	DAX/OR-1x42W. H.F.	117,51 €	(1,3)
032150053218	DAX/OR-2x18W. H.F.	122,87 €	(1,5)
032150053226	DAX/OR-2x26W. H.F.	122,87 €	(1,5)
032150053232	DAX/OR-2x32W. H.F.	122,87 €	(1,5)

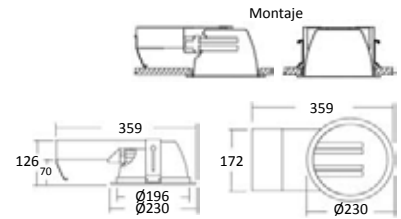

032150062118	DAX/MA-1x18W. 230V. A.F.	86,80 €	(2,3)
032150062126	DAX/MA-1x26W. 230V. A.F.	86,80 €	(2,4)
032150062218	DAX/MA-2x18W. 230V. A.F.	95,32 €	(2,3)
032150062226	DAX/MA-2x26W. 230V. A.F.	95,32 €	(2,4)
032150063118	DAX/MA-1x18W. H.F.	117,51 €	(1,3)
032150063126	DAX/MA-1x26W. H.F.	117,51 €	(1,3)
032150063132	DAX/MA-1x32W. H.F.	117,51 €	(1,3)
032150063142	DAX/MA-1x42W. H.F.	117,51 €	(1,3)
032150063218	DAX/MA-2x18W. H.F.	122,87 €	(1,5)
032150063226	DAX/MA-2x26W. H.F.	122,87 €	(1,5)
032150063232	DAX/MA-2x32W. H.F.	122,87 €	(1,5)

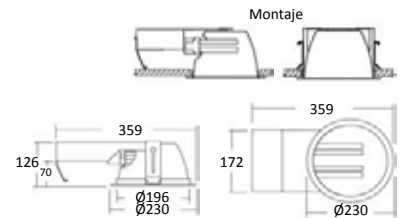

032150072118	DAX/G-1x18W. 230V. A.F.	86,80 €	(2,3)
032150072126	DAX/G-1x26W. 230V. A.F.	86,80 €	(2,4)
032150072218	DAX/G-2x18W. 230V. A.F.	95,32 €	(2,3)
032150072226	DAX/G-2x26W. 230V. A.F.	95,32 €	(2,4)
032150073118	DAX/G-1x18W. H.F.	117,51 €	(1,3)
032150073126	DAX/G-1x26W. H.F.	117,51 €	(1,3)
032150073132	DAX/G-1x32W. H.F.	117,51 €	(1,3)
032150073142	DAX/G-1x42W. H.F.	117,51 €	(1,3)
032150073218	DAX/G-2x18W. H.F.	122,87 €	(1,5)
032150073226	DAX/G-2x26W. H.F.	122,87 €	(1,5)
032150073232	DAX/G-2x32W. H.F.	122,87 €	(1,5)

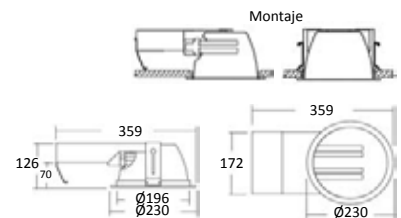

032150082118	DAX/C-1x18W. 230V. A.F.	86,80 €	(2,3)
032150082126	DAX/C-1x26W. 230V. A.F.	86,80 €	(2,4)
032150082218	DAX/C-2x18W. 230V. A.F.	95,32 €	(2,3)
032150082226	DAX/C-2x26W. 230V. A.F.	95,32 €	(2,4)
032150083118	DAX/C-1x18W. H.F.	117,51 €	(1,3)
032150083126	DAX/C-1x26W. H.F.	117,51 €	(1,3)
032150083132	DAX/C-1x32W. H.F.	117,51 €	(1,3)
032150083142	DAX/C-1x42W. H.F.	117,51 €	(1,3)
032150083218	DAX/C-2x18W. H.F.	122,87 €	(1,5)
032150083226	DAX/C-2x26W. H.F.	122,87 €	(1,5)
032150083232	DAX/C-2x32W. H.F.	122,87 €	(1,5)

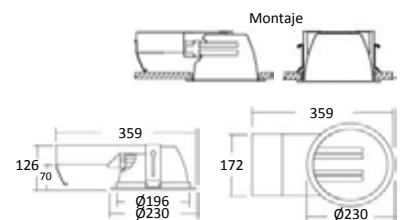

Materiales: Cuerpo en acero galvanizado, reflector de policarbonato metalizado, aro embellecedor de cristal.

CODIGO	REFERENCIA	P.V.P.	Kg.
0321442113	DEBP/DEC-1x13W. 230V. A.F.	66,07 €	(2,6)
0321442118	DEBP/DEC-1x18W. 230V. A.F.	66,07 €	(2,6)
0321442126	DEBP/DEC-1x26W. 230V. A.F.	66,07 €	(2,6)
0321442213	DEBP/DEC-2x13W. 230V. A.F.	74,55 €	(3,3)
0321442218	DEBP/DEC-2x18W. 230V. A.F.	74,55 €	(3,3)
0321442226	DEBP/DEC-2x26W. 230V. A.F.	74,55 €	(3,3)
0321443113	DEBP/DEC-1x13W. H.F.	101,61 €	(2,2)
0321443118	DEBP/DEC-1x18W. H.F.	101,61 €	(2,2)
0321443126	DEBP/DEC-1x26W. H.F.	101,61 €	(2,2)
0321443213	DEBP/DEC-2x13W. H.F.	110,97 €	(2,3)
0321443218	DEBP/DEC-2x18W. H.F.	110,97 €	(2,3)
0321443226	DEBP/DEC-2x26W. H.F.	110,97 €	(2,3)

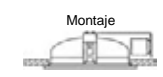
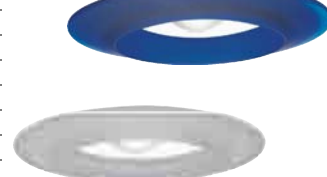

Caja porta-equipos incluida



CARTA DE COLORES



DOWNLIGHTS ADOSABLES / SUPENDIDOS



Materiales: Cuerpo en chapa de acero, difusor de material termoplástico opalino.

CODIGO	REFERENCIA	Indice rendimiento de color CRI (Ra)	Temperatura de color CCT (k)	P.V.P.	Kg.
DK1L010	KER LED-1x10W 700lm/927	>90	2700	261,04 €	(1,3)
DK1L0153	KER LED-1x15W 1000lm/930	>90	3000	293,83 €	(1,3)
DK1L0154	KER LED-1x15W 1000lm/940	>90	4000	293,83 €	(1,3)



Estándar color blanco RAL 9003, color gris RAL 9006 bajo consulta.



Materiales: Cuerpo en chapa de acero, difusor de material termoplástico opalino.

CODIGO	REFERENCIA	Indice rendimiento de color CRI (Ra)	Temperatura de color CCT (k)	P.V.P.	Kg.
DK2L010	KERSUS LED-1x10W 700lm/927	>90	2700	292,66 €	(1,3)
DK2L0153	KERSUS LED-1x15W 1000lm/930	>90	3000	325,45 €	(1,3)
DK2L0154	KERSUS LED-1x15W 1000lm/940	>90	4000	325,45 €	(1,3)

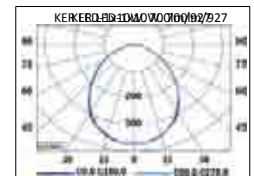
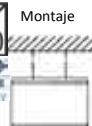

Estándar color blanco RAL 9003, color gris RAL 9006 bajo consulta.

Suspensiones incluidas.



Materiales: Cuerpo en chapa de acero, difusor de material termoplástico opalino.

CODIGO	REFERENCIA	Indice rendimiento de color CRI (Ra)	Temperatura de color CCT (k)	P.V.P.	Kg.
DK3L010	KERPAR LED-1x10W 700lm/927	>90	2700	238,12 €	(1,3)
DK3L0153	KERPAR LED-1x15W 1000lm/930	>90	3000	270,91 €	(1,3)
DK3L0154	KERPAR LED-1x15W 1000lm/940	>90	4000	270,91 €	(1,3)

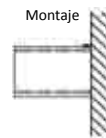

Estándar color blanco RAL 9003, color gris RAL 9006 bajo consulta.

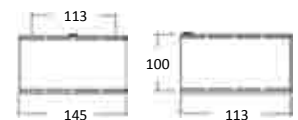

DOWNLIGHTS ADOSABLES



Materiales: Cuerpo en chapa de acero, reflector de aluminio, difusor microprismático.

CODIGO	REFERENCIA	P.V.P.	Kg.
032101L115	CILINDER/LED-17W. 1150lm/830	402,56 €	(2,3)
032101L125	CILINDER/LED-17W. 1250lm/840	402,56 €	(2,3)
032101L158	CILINDER/LED-25W. 1580lm/830	432,88 €	(2,3)
032101L170	CILINDER/LED-25W. 1700lm/840	432,88 €	(2,3)

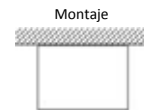

Color blanco RAL 9003.

Estandar, equipo de control electrónico EEI=A2.

Bajo consulta, equipo de control electrónico dimmable DALI EEI=A1.

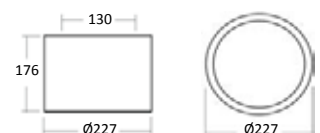
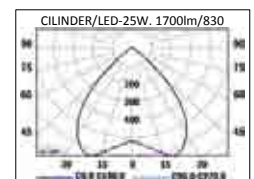

DOWNLIGHTS ADOSABLES

Materiales: Cuerpo de chapa en acero color blanco, reflector de aluminio anodizado brillante.

CODIGO	REFERENCIA	P.V.P.	Kg.
0321012113B	CILINDER/B-1x13W. 230V. A.F. (TC-D)	53,33 €	(1,8)
0321012118B	CILINDER/B-1x18W. 230V. A.F. (TC-D)	53,33 €	(1,8)
0321012126B	CILINDER/B-1x26W. 230V. A.F. (TC-T)	53,33 €	(1,8)
0321012213B	CILINDER/B-2x13W. 230V. A.F. (TC-D)	62,15 €	(2,1)
0321012218B	CILINDER/B-2x18W. 230V. A.F. (TC-D)	62,15 €	(2,1)
0321013113B	CILINDER/B-1x13W. H.F. (TC-DEL)	92,59 €	(1,5)
0321013118B	CILINDER/B-1x18W. H.F. (TC-DEL)	92,59 €	(1,5)
0321013126B	CILINDER/B-1x26W. H.F. (TC-TEL)	92,59 €	(1,5)
0321013213B	CILINDER/B-2x13W. H.F. (TC-DEL)	98,08 €	(1,6)
0321013218B	CILINDER/B-2x18W. H.F. (TC-DEL)	98,08 €	(1,6)
0321013226B	CILINDER/B-2x26W. H.F. (TC-DEL)	98,08 €	(1,6)

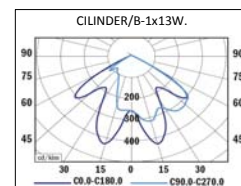
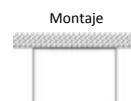

LOR= 77.60%

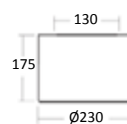

Materiales: Cuerpo de chapa en acero color cromo, reflector de aluminio anodizado brillante.

CODIGO	REFERENCIA	P.V.P.	Kg.
0321012113C	CILINDER/C-1x13W. 230V. A.F. (TC-D)	211,40 €	(1,8)
0321012118C	CILINDER/C-1x18W. 230V. A.F. (TC-D)	211,40 €	(1,8)
0321012126C	CILINDER/C-1x26W. 230V. A.F. (TC-T)	211,40 €	(1,8)
0321012213C	CILINDER/C-2x13W. 230V. A.F. (TC-D)	219,43 €	(2,1)
0321012218C	CILINDER/C-2x18W. 230V. A.F. (TC-D)	219,43 €	(2,1)
0321013113C	CILINDER/C-1x13W. H.F. (TC-DEL)	237,55 €	(1,5)
0321013118C	CILINDER/C-1x18W. H.F. (TC-DEL)	237,55 €	(1,5)
0321013126C	CILINDER/C-1x26W. H.F. (TC-TEL)	237,55 €	(1,5)
0321013213C	CILINDER/C-2x13W. H.F. (TC-DEL)	245,06 €	(1,6)
0321013218C	CILINDER/C-2x18W. H.F. (TC-DEL)	245,06 €	(1,6)
0321013226C	CILINDER/C-2x26W. H.F. (TC-DEL)	245,06 €	(1,6)

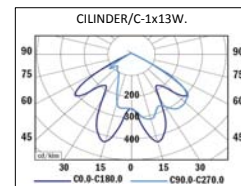
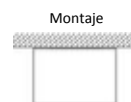

LOR= 77.60%

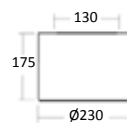

Materiales: Cuerpo de chapa en acero color blanco, reflector parabólico turbo de aluminio anodizado brillante.

CODIGO	REFERENCIA	P.V.P.	Kg.
0324602113B	TURBO CILINDER/B-1x13W. 230V. A.F. (TC-D)	65,38 €	(2,2)
0324602118B	TURBO CILINDER/B-1x18W. 230V. A.F. (TC-D)	65,38 €	(2,2)
0324602126B	TURBO CILINDER/B-1x26W. 230V. A.F. (TC-T)	65,38 €	(2,2)
0324602213B	TURBO CILINDER/B-2x13W. 230V. A.F. (TC-D)	74,20 €	(2,5)
0324602218B	TURBO CILINDER/B-2x18W. 230V. A.F. (TC-D)	74,20 €	(2,5)
0324603113B	TURBO CILINDER/B-1x13W. H.F. (TC-DEL)	101,91 €	(1,9)
0324603118B	TURBO CILINDER/B-1x18W. H.F. (TC-DEL)	101,91 €	(1,9)
0324603126B	TURBO CILINDER/B-1x26W. H.F. (TC-TEL)	101,91 €	(1,9)
0324603213B	TURBO CILINDER/B-2x13W. H.F. (TC-DEL)	109,64 €	(2,0)
0324603218B	TURBO CILINDER/B-2x18W. H.F. (TC-DEL)	109,64 €	(2,0)
0324603226B	TURBO CILINDER/B-2x26W. H.F. (TC-DEL)	109,64 €	(2,0)

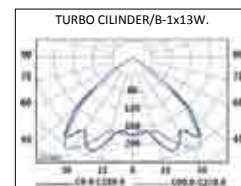
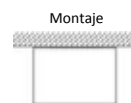

LOR= 48.00%

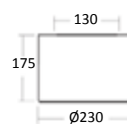

Materiales: Cuerpo de chapa en acero color cromo, reflector parabólico turbo de aluminio anodizado brillante.

CODIGO	REFERENCIA	P.V.P.	Kg.
0324602113C	TURBO CILINDER/C-1x13W. 230V. A.F. (TC-D)	221,87 €	(2,2)
0324602118C	TURBO CILINDER/C-1x18W. 230V. A.F. (TC-D)	221,87 €	(2,2)
0324602126C	TURBO CILINDER/C-1x26W. 230V. A.F. (TC-T)	221,87 €	(2,2)
0324602213C	TURBO CILINDER/C-2x13W. 230V. A.F. (TC-D)	228,86 €	(2,5)
0324602218C	TURBO CILINDER/C-2x18W. 230V. A.F. (TC-D)	228,86 €	(2,5)
0324603113C	TURBO CILINDER/C-1x13W. H.F. (TC-DEL)	248,82 €	(1,9)
0324603118C	TURBO CILINDER/C-1x18W. H.F. (TC-DEL)	248,82 €	(1,9)
0324603126C	TURBO CILINDER/C-1x26W. H.F. (TC-TEL)	248,82 €	(1,9)
0324603213C	TURBO CILINDER/C-2x13W. H.F. (TC-DEL)	256,33 €	(2,0)
0324603218C	TURBO CILINDER/C-2x18W. H.F. (TC-DEL)	256,33 €	(2,0)
0324603226C	TURBO CILINDER/C-2x26W. H.F. (TC-DEL)	256,33 €	(2,0)

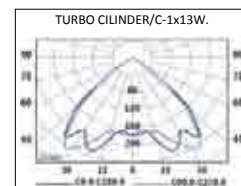
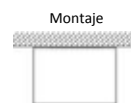

LOR= 48.00%

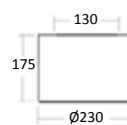

Materiales: Cuerpo de chapa en acero color blanco, reflector de aluminio anodizado brillante, cristal opal.

CODIGO	REFERENCIA	P.V.P.	Kg.
0321062113B	CILINDER/OPAL-IP40-1x13W. 230V. A.F. (TC-D)	67,26 €	(2,3)
0321062118B	CILINDER/OPAL-IP40-1x18W. 230V. A.F. (TC-D)	67,26 €	(2,3)
0321062126B	CILINDER/OPAL-IP40-1x26W. 230V. A.F. (TC-T)	67,26 €	(2,3)
0321062213B	CILINDER/OPAL-IP40-2x13W. 230V. A.F. (TC-D)	76,89 €	(2,4)
0321062218B	CILINDER/OPAL-IP40-2x18W. 230V. A.F. (TC-D)	76,89 €	(2,4)
0321063113B	CILINDER/OPAL-IP40-1x13W. H.F. (TC-DEL)	110,15 €	(1,8)
0321063118B	CILINDER/OPAL-IP40-1x18W. H.F. (TC-DEL)	110,15 €	(1,8)
0321063126B	CILINDER/OPAL-IP40-1x26W. H.F. (TC-TEL)	110,15 €	(1,8)
0321063213B	CILINDER/OPAL-IP40-2x13W. H.F. (TC-DEL)	114,84 €	(1,9)
0321063218B	CILINDER/OPAL-IP40-2x18W. H.F. (TC-DEL)	114,84 €	(1,9)
0321063226B	CILINDER/OPAL-IP40-2x26W. H.F. (TC-DEL)	114,84 €	(1,9)

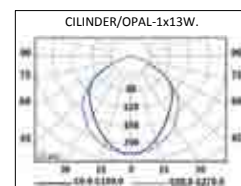
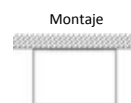

LOR= 58.40%

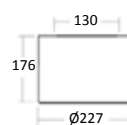

DOWNLIGHTS ADOSABLES

Materiales: Cuerpo en chapa de acero color blanco, reflector de aluminio anodizado brillante, cristal suspendido transparente.

CODIGO	REFERENCIA	P.V.P.	Kg.
0321032113B	CILINDER/DGA-1x13W. 230V. A.F. (TC-D)	84,91 €	(2,2)
0321032118B	CILINDER/DGA-1x18W. 230V. A.F. (TC-D)	84,91 €	(2,2)
0321032126B	CILINDER/DGA-1x26W. 230V. A.F. (TC-T)	84,91 €	(2,2)
0321032213B	CILINDER/DGA-2x13W. 230V. A.F. (TC-D)	94,65 €	(2,3)
0321032218B	CILINDER/DGA-2x18W. 230V. A.F. (TC-D)	94,65 €	(2,3)
0321033113B	CILINDER/DGA-1x13W. H.F. (TC-DEL)	131,96 €	(1,7)
0321033118B	CILINDER/DGA-1x18W. H.F. (TC-DEL)	131,96 €	(1,7)
0321033126B	CILINDER/DGA-1x26W. H.F. (TC-TEL)	131,96 €	(1,7)
0321033213B	CILINDER/DGA-2x13W. H.F. (TC-DEL)	137,48 €	(1,8)
0321033218B	CILINDER/DGA-2x18W. H.F. (TC-DEL)	137,48 €	(1,8)
0321033226B	CILINDER/DGA-2x26W. H.F. (TC-DEL)	137,48 €	(1,8)

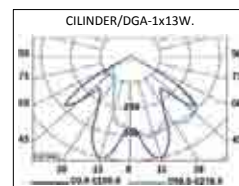
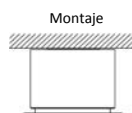

LOR= 73.40%

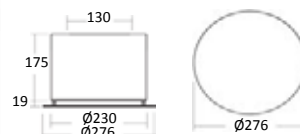

Materiales: Cuerpo en chapa de acero color blanco, reflector de aluminio anodizado brillante, cristal serigrafiado.

CODIGO	REFERENCIA	P.V.P.	Kg.
032452113	DEB/S-1x13W. 230V. A.F.	71,32 €	(2,6)
032452118	DEB/S-1x18W. 230V. A.F.	71,32 €	(2,6)
032452126	DEB/S-1x26W. 230V. A.F.	71,32 €	(2,6)
032452213	DEB/S-2x13W. 230V. A.F.	80,45 €	(3,2)
032452218	DEB/S-2x18W. 230V. A.F.	80,45 €	(3,2)
032452226	DEB/S-2x26W. 230V. A.F.	80,45 €	(3,2)
032453113	DEB/S-1x13W. H.F.	100,28 €	(2,2)
032453118	DEB/S-1x18W. H.F.	100,28 €	(2,2)
032453126	DEB/S-1x26W. H.F.	100,28 €	(2,2)
032453213	DEB/S-2x13W. H.F.	123,37 €	(2,3)
032453218	DEB/S-2x18W. H.F.	123,37 €	(2,3)
032453226	DEB/S-2x26W. H.F.	123,37 €	(2,3)



Muy baja altura: 94 mm.

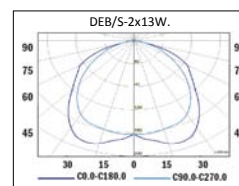

LOR= 49.75%



Materiales: Cuerpo en chapa de acero metalizado satinado plata, reflector de aluminio anodizado brillante, cristal serigrafiado.

CODIGO	REFERENCIA	P.V.P.	Kg.
032472113	DEN/S-1x13W. 230V. A.F.	94,81 €	(2,6)
032472118	DEN/S-1x18W. 230V. A.F.	94,81 €	(2,6)
032472126	DEN/S-1x26W. 230V. A.F.	94,81 €	(2,6)
032472213	DEN/S-2x13W. 230V. A.F.	103,33 €	(3,2)
032472218	DEN/S-2x18W. 230V. A.F.	103,33 €	(3,2)
032472226	DEN/S-2x26W. 230V. A.F.	103,33 €	(3,2)
032473113	DEN/S-1x13W. H.F.	123,77 €	(2,2)
032473118	DEN/S-1x18W. H.F.	123,77 €	(2,2)
032473126	DEN/S-1x26W. H.F.	123,77 €	(2,2)
032473213	DEN/S-2x13W. H.F.	146,25 €	(2,3)
032473218	DEN/S-2x18W. H.F.	146,25 €	(2,3)
032473226	DEN/S-2x26W. H.F.	146,25 €	(2,3)



Muy baja altura: 94 mm.



Muy baja altura: 94 mm.

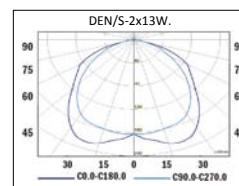

LOR= 49.75%

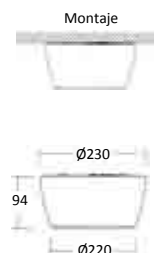

DENE/S, DEGR/S, DEOS/S, DEOB/S, DECB/S, mismo precio.

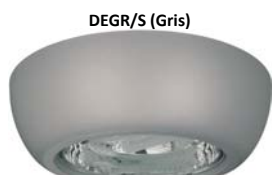

Muy baja altura: 94 mm.



Muy baja altura: 94 mm.



Muy baja altura: 94 mm.



Muy baja altura: 94 mm.

Materiales: Cuerpo en policarbonato blanco, reflector de aluminio anodizado brillante, cristal moteado.

CODIGO	REFERENCIA	P.V.P.	Kg.
03210201070	PERLA/G12-70W. 230V. HIT	163,11 €	(3,4)

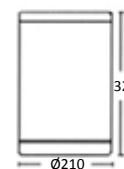
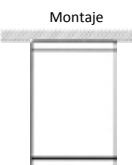

DOWNLIGHTS ADOSABLES

Materiales: Cuerpo en aluminio inyectado, reflector de aluminio anodizado brillante, cristal transparente.

CODIGO	REFERENCIA	P.V.P.	Kg.
0323033118	GEMA/IP40-1x18W. H.F. (TC-TEL)	165,67 €	(2,0)
0323033126	GEMA/IP40-1x26W. H.F. (TC-TEL)	165,67 €	(2,0)
0323033218	GEMA/IP40-2x18W. H.F. (TC-TEL)	171,39 €	(2,1)
0323033226	GEMA/IP40-2x26W. H.F. (TC-TEL)	171,39 €	(2,1)

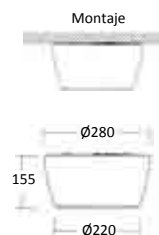

0323033118G	GEMA/GRIS/IP40-1x18W. H.F. (TC-TEL)	183,87 €	(2,0)
0323033126G	GEMA/GRIS/IP40-1x26W. H.F. (TC-TEL)	183,87 €	(2,0)
0323033218G	GEMA/GRIS/IP40-2x18W. H.F. (TC-TEL)	189,59 €	(2,1)
0323033226G	GEMA/GRIS/IP40-2x26W. H.F. (TC-TEL)	189,59 €	(2,1)

Materiales: Cuerpo en aluminio inyectado, reflector de aluminio anodizado brillante, cristal opal.

CODIGO	REFERENCIA	P.V.P.	Kg.
0323043118	GEMA/OPAL/IP40-1x18W. H.F. (TC-TEL)	165,67 €	(2,0)
0323043126	GEMA/OPAL/IP40-1x26W. H.F. (TC-TEL)	165,67 €	(2,0)
0323043218	GEMA/OPAL/IP40-2x18W. H.F. (TC-TEL)	171,39 €	(2,1)
0323043226	GEMA/OPAL/IP40-2x26W. H.F. (TC-TEL)	171,39 €	(2,1)

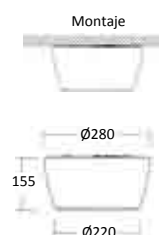

0323043118G	GEMA/OPAL/GRIS/IP40-1x18W. H.F. (TC-TEL)	183,87 €	(2,0)
0323043126G	GEMA/OPAL/GRIS/IP40-1x26W. H.F. (TC-TEL)	183,87 €	(2,0)
0323043218G	GEMA/OPAL/GRIS/IP40-2x18W. H.F. (TC-TEL)	189,59 €	(2,1)
0323043226G	GEMA/OPAL/GRIS/IP40-2x26W. H.F. (TC-TEL)	189,59 €	(2,1)

Materiales: Cuerpo en aluminio inyectado, reflector de aluminio anodizado brillante facetado.

CODIGO	REFERENCIA	P.V.P.	Kg.
0323003118	GEMA-1x18W. H.F. (TC-TEL)	139,90 €	(1,5)
0323003126	GEMA-1x26W. H.F. (TC-TEL)	139,90 €	(1,5)
0323003132	GEMA-1x32W. H.F. (TC-TEL)	139,90 €	(1,5)
0323003218	GEMA-2x18W. H.F. (TC-TEL)	146,68 €	(1,6)
0323003226	GEMA-2x26W. H.F. (TC-TEL)	146,68 €	(1,6)

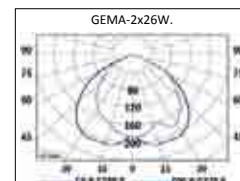
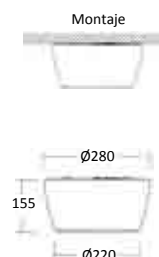

LOR= 48.96%

0323003118G	GEMA/GRIS-1x18W. H.F. (TC-TEL)	158,09 €	(1,5)
0323003126G	GEMA/GRIS-1x26W. H.F. (TC-TEL)	158,09 €	(1,5)
0323003132G	GEMA/GRIS-1x32W. H.F. (TC-TEL)	158,09 €	(1,5)
0323003218G	GEMA/GRIS-2x18W. H.F. (TC-TEL)	164,87 €	(1,6)
0323003226G	GEMA/GRIS-2x26W. H.F. (TC-TEL)	164,87 €	(1,6)

DOWNLIGHTS PENDULARES

Materiales: Cuerpo en aluminio inyectado, reflector de aluminio anodizado brillante facetado, cubierta superior de cristal oval endurecido satinado mate.

CODIGO	REFERENCIA	P.V.P.	Kg.
03230130701	GEMA-OVALY-1x70W. HIT+1x42W. (GX24Q-4) H.F.	727,31 €	(2,5)
0323013070	GEMA-OVALY-1x70W. HIT+1x57W. (GX24Q-5) H.F.	727,31 €	(2,5)
03230132261	GEMA-OVALY-2x26W. (TC-TEL)+1x42W. (GX24Q-4) H.F.	585,40 €	(2,6)
0323013226	GEMA-OVALY-2x26W. (TC-TEL)+1x57W. (GX24Q-5) H.F.	585,40 €	(2,6)
03230130701G	GEMA-OVALY/GRIS-1x70W. HIT+1x42W. (GX24Q-4) H.F.	745,51 €	(2,5)
0323013070G	GEMA-OVALY/GRIS-1x70W. HIT+1x57W. (GX24Q-5) H.F.	745,51 €	(2,5)
03230132261G	GEMA-OVALY/GRIS-2x26W. (TC-TEL)+1x42W. (GX24Q-4) H.F.	603,59 €	(2,6)
0323013226G	GEMA-OVALY/GRIS-2x26W. (TC-TEL)+1x57W. (GX24Q-5) H.F.	603,59 €	(2,6)

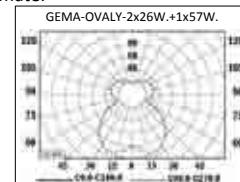
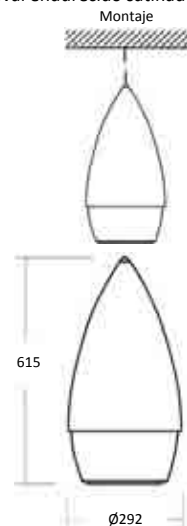
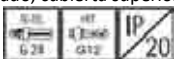

LOR= 49.22%

EMPOTRABLES SECCION REDUCIDA T-5 LINEAS CONTINUAS

Cuerpo luminaria: Sección reducida, acero esmaltado en color blanco RAL.9003. Anclajes de fijación (4 uds.) para techos lisos.

Opticas : Difusores dobles parabólicos en aluminio brillante o satinado mate. Fijación mediante muelles de presión.

"BR" (doble parabólico brillante, aluminio Alanod 316G2), "BR/MIRO" (doble parabólico brillante, aluminio Miro 4).

"MR" (doble parabólico satinado mate, aluminio Alanod 1100G), "MR/MIRO" (doble parabólico satinado mate, aluminio Miro 5).

"OPAL" (Difusor en policarbonato) bajo consulta.

Equipo eléctrico : Luminarias equipadas con balastos electrónicos EEI= A2.

Bajo consulta, balastos electrónicos regulables, EEI= A1 (pueden ser controlados analógicamente 1-10V, digital o Dali).

CODIGO	REFERENCIA	P.V.P.	Kg.	IP 20
13725213128F	T5-PTE/BR/LINEA-F-1x28W. H.F.	170,02 €	(2,4)	100x1175
13725213128T	T5-PTE/BR/LINEA-T-1x28W. H.F.	170,02 €	(2,4)	100x1170
13725213128U	T5-PTE/BR/LINEA-L-1x28W. H.F.	160,05 €	(2,4)	100x1175
13725213154F	T5-PTE/BR/LINEA-F-1x54W. H.F.	170,02 €	(2,4)	100x1175
13725213154T	T5-PTE/BR/LINEA-T-1x54W. H.F.	170,02 €	(2,4)	100x1170
13725213154U	T5-PTE/BR/LINEA-L-1x54W. H.F.	160,05 €	(2,4)	100x1175
13725213135F	T5-PTE/BR/LINEA-F-1x35W. H.F.	181,63 €	(3,0)	100x1475
13725213135T	T5-PTE/BR/LINEA-T-1x35W. H.F.	181,63 €	(3,0)	100x1470
13725213135U	T5-PTE/BR/LINEA-L-1x35W. H.F.	171,45 €	(3,0)	100x1475
13725213149F	T5-PTE/BR/LINEA-F-1x49W. H.F.	181,63 €	(3,0)	100x1475
13725213149T	T5-PTE/BR/LINEA-T-1x49W. H.F.	181,63 €	(3,0)	100x1470
13725213149U	T5-PTE/BR/LINEA-L-1x49W. H.F.	171,45 €	(3,0)	100x1475
13725213180F	T5-PTE/BR/LINEA-F-1x80W. H.F.	197,66 €	(3,0)	100x1475
13725213180T	T5-PTE/BR/LINEA-T-1x80W. H.F.	197,66 €	(3,0)	100x1470
13725213180U	T5-PTE/BR/LINEA-L-1x80W. H.F.	187,48 €	(3,0)	100x1475
13725213228F	T5-PTE/BR/LINEA-F-2x28W. H.F.	179,89 €	(2,4)	100x1175
13725213228T	T5-PTE/BR/LINEA-T-2x28W. H.F.	179,89 €	(2,4)	100x1170
13725213228U	T5-PTE/BR/LINEA-L-2x28W. H.F.	169,93 €	(2,4)	100x1175
13725213254F	T5-PTE/BR/LINEA-F-2x54W. H.F.	179,89 €	(2,4)	100x1175
13725213254T	T5-PTE/BR/LINEA-T-2x54W. H.F.	179,89 €	(2,4)	100x1170
13725213254U	T5-PTE/BR/LINEA-L-2x54W. H.F.	169,93 €	(2,4)	100x1175
13725213235F	T5-PTE/BR/LINEA-F-2x35W. H.F.	191,46 €	(3,0)	100x1475
13725213235T	T5-PTE/BR/LINEA-T-2x35W. H.F.	191,46 €	(3,0)	100x1470
13725213235U	T5-PTE/BR/LINEA-L-2x35W. H.F.	181,28 €	(3,0)	100x1475
13725213249F	T5-PTE/BR/LINEA-F-2x49W. H.F.	191,46 €	(3,0)	100x1475
13725213249T	T5-PTE/BR/LINEA-T-2x49W. H.F.	191,46 €	(3,0)	100x1470
13725213249U	T5-PTE/BR/LINEA-L-2x49W. H.F.	181,28 €	(3,0)	100x1475
13725213280F	T5-PTE/BR/LINEA-F-2x80W. H.F.	230,84 €	(3,0)	100x1475
13725213280T	T5-PTE/BR/LINEA-T-2x80W. H.F.	230,84 €	(3,0)	100x1470
13725213280U	T5-PTE/BR/LINEA-L-2x80W. H.F.	220,66 €	(3,0)	100x1475

DIFUSOR MATE, T5-PTE/MR/LINEA-F,T,L "MISMO PRECIO".

ALUMINIO MIRO 4 (BRILLO), bajo consulta.

ALUMINIO MIRO 5 (SATINADO MATE), bajo consulta.

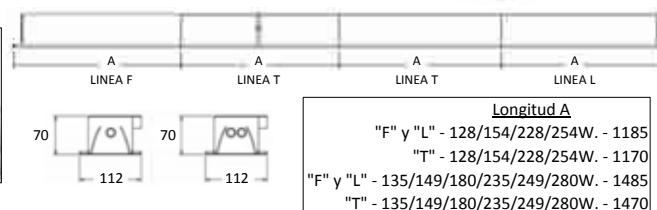
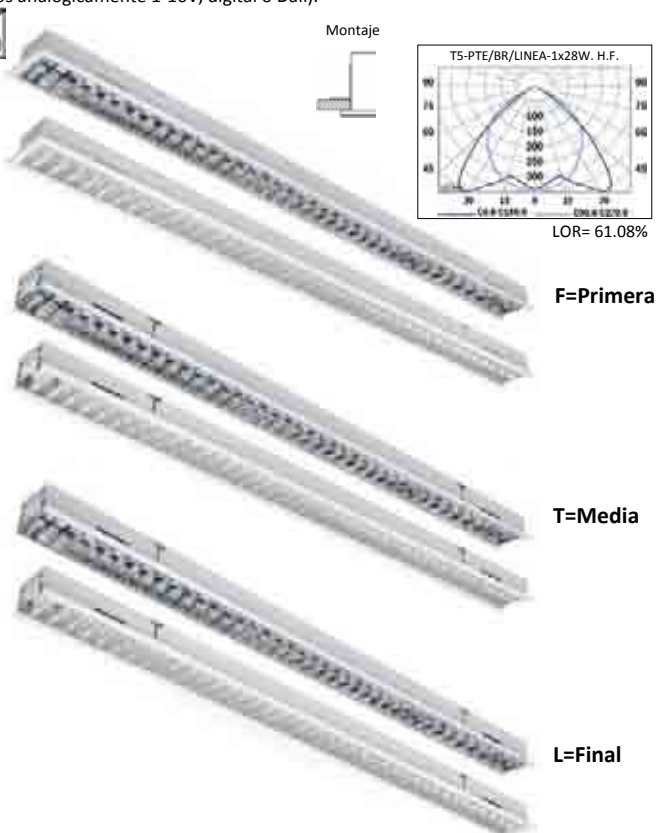

EMPOTRABLES SECCION REDUCIDA T-5

Cuerpo luminaria: Sección reducida, acero esmaltado en color blanco RAL.9003. Anclajes de fijación (4 uds.) para techos lisos.

Opticas : Difusores dobles parabólicos en aluminio brillante o satinado mate. Fijación mediante muelles de presión.

"BR" (doble parabólico brillante, aluminio Alanod 316G2), "BR/MIRO" (doble parabólico brillante, aluminio Miro 4).

"MR" (doble parabólico satinado mate, aluminio Alanod 1100G), "MR/MIRO" (doble parabólico satinado mate, aluminio Miro 5).

"OPAL" (Difusor en policarbonato) bajo consulta.

Recuperador de flujo incluido, muy alta eficiencia 80%.

Equipo eléctrico : Luminarias equipadas con balastos electrónicos EEI= A2.

Bajo consulta, balastos electrónicos regulables, EEI= A1 (pueden ser controlados analógicamente 1-10V, digital o Dali).

CODIGO	REFERENCIA	P.V.P.	Kg.	IP 20
13725213128	T5-PTE/BR-1x28W H.F.	144,89 €	(2,4)	100x1180
13725213154	T5-PTE/BR-1x54W H.F.	144,89 €	(2,4)	100x1180
13725213135	T5-PTE/BR-1x35W H.F.	156,29 €	(3,0)	100x1480
13725213149	T5-PTE/BR-1x49W H.F.	156,29 €	(3,0)	100x1480
13725213180	T5-PTE/BR-1x80W H.F.	172,31 €	(3,0)	100x1480
13725213228	T5-PTE/BR-2x28W H.F.	154,77 €	(2,4)	100x1180
13725213254	T5-PTE/BR-2x54W H.F.	154,77 €	(2,4)	100x1180
13725213235	T5-PTE/BR-2x35W H.F.	166,12 €	(3,0)	100x1480
13725213249	T5-PTE/BR-2x49W H.F.	166,12 €	(3,0)	100x1480
13725213280	T5-PTE/BR-2x80W H.F.	205,50 €	(3,0)	100x1480

DIFUSOR MATE, T5-PTE/MR/LINEA-F,T,L "MISMO PRECIO".

ALUMINIO MIRO 4 (BRILLO), bajo consulta.

ALUMINIO MIRO 5 (SATINADO MATE), bajo consulta.

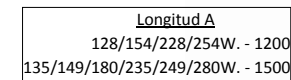
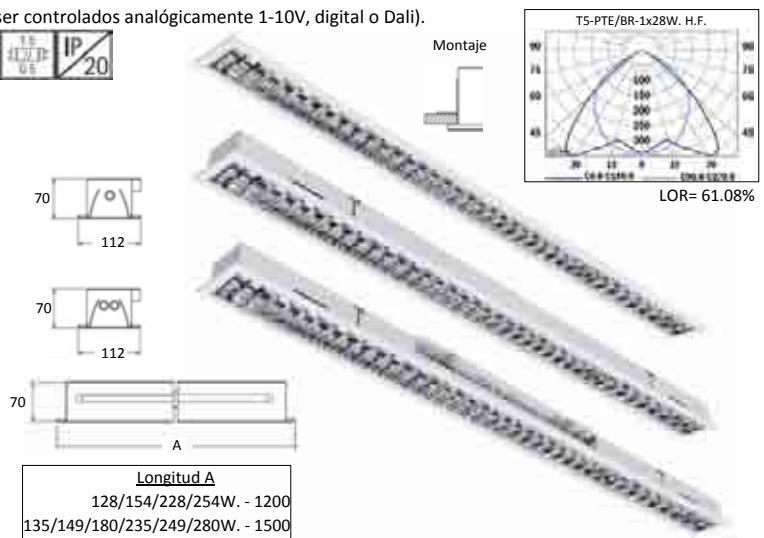

EMPOTRABLE DECORATIVA



Materiales: Luminaria de alta gama y excelente acabado, en chapa de acero, difusor de acero inoxidable, marco decorativo en chapa de acero pintado en color Blanco RAL 9003.

CODIGO	REFERENCIA	Indice rendimiento de color CRI (Ra)	Temperatura de color CCT (k)	Forma	P.V.P. Kg.
LARL0283	ARIAN 28W. LED DALI 1300/830	>80	3000	3 ó 4	1.941,60 € (9,3)
LARL0284	ARIAN 28W. LED DALI 1500/830-757	>70	3000-5700	3 ó 4	2.184,10 € (9,3)
LARL0403	ARIAN 40W. LED DALI 1720/830	>80	3000	3 ó 4	1.941,60 € (9,3)
LARL0404	ARIAN 40W. LED DALI 2000/830-757	>70	3000-5700	3 ó 4	2.184,10 € (9,3)
LARL0423	ARIAN 42W. LED DALI 1950/830	>80	3000	5 ó 6	2.721,27 € (9,3)
LARL0424	ARIAN 42W. LED DALI 2250/830-757	>70	3000-5700	5 ó 6	2.739,94 € (9,3)
LARL0603	ARIAN 60W. LED DALI 2340/830	>80	3000	5 ó 6	2.721,27 € (9,3)
LARL0604	ARIAN 60W. LED DALI 2750/830-757	>70	3000-5700	5 ó 6	2.739,94 € (9,3)
LARL0353	ARIAN 35W. LED DALI 1625/830	>80	3000	7	1.917,94 € (9,3)
LARL0354	ARIAN 35W. LED DALI 1900/830-757	>70	3000-5700	7	1.917,94 € (9,3)
LARL0503	ARIAN 50W. LED DALI 2150/830	>80	3000	7	1.917,94 € (9,3)
LARL0504	ARIAN 50W. LED DALI 2500/830-757	>70	3000-5700	7	1.917,94 € (9,3)
LARL0703	ARIAN 70W. LED DALI 3250/830	>80	3000	8	3.534,12 € (9,3)
LARL0704	ARIAN 70W. LED DALI 3750/830-757	>70	3000-5700	8	3.534,12 € (9,3)
LARL1003	ARIAN 100W. LED DALI 4300/830	>80	3000	8	3.534,12 € (9,3)
LARL1004	ARIAN 100W. LED DALI 5000/830-757	>70	3000-5700	8	3.534,12 € (9,3)
LARL0773	ARIAN 77W. LED DALI 4300/830	>80	3000	9	4.199,04 € (9,3)
LARL0774	ARIAN 77W. LED DALI 5000/830-757	>70	3000-5700	9	4.199,04 € (9,3)
LARL1103	ARIAN 110W. LED DALI 4520/830	>80	3000	9	4.199,04 € (9,3)
LARL1104	ARIAN 110W. LED DALI 5130/830-757	>70	3000-5700	9	4.199,04 € (9,3)

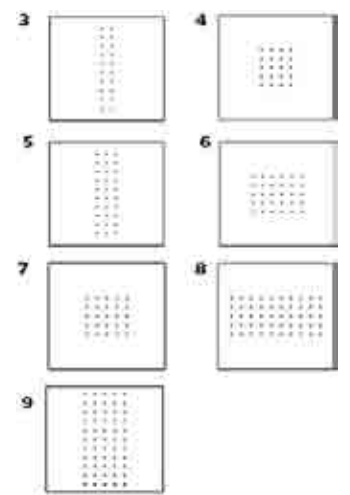
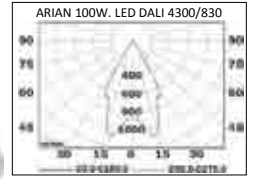

Todos los modelos ARIAN están disponibles también con temperatura de color de luz 757 y 740.

Bajo consulta, equipo de control electrónico regulable DALI RGB "colores de luz variables".

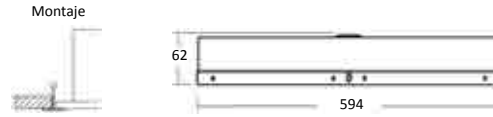

Materiales: Luminaria de alta gama y excelente acabado, en chapa de acero RAL 9003, difusor microprisma lineal, disipador en perfil de aluminio.

CODIGO	REFERENCIA	Indice rendimiento de color CRI (Ra)	Temperatura de color CCT (k)	P.V.P. Kg.
LIROL280	IRIS 36W. LED 2800/830	>80	3000	PENDIENTE DE FABRICACION
LIROL300	IRIS 36W. LED 3000/840	>80	4000	PENDIENTE DE FABRICACION



Equipo de control electrónico, bajo consulta equipo de control electrónico regulable (EE=A1 - DALI).

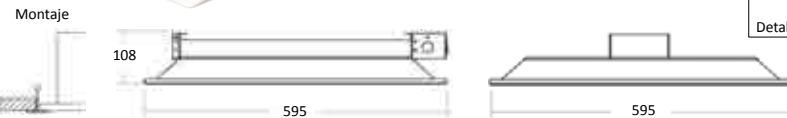

Materiales: Luminaria de alta gama y excelente acabado, en chapa de acero RAL 9003, difusor opal.

CODIGO	REFERENCIA	Indice rendimiento de color CRI (Ra)	Temperatura de color CCT (k)	P.V.P. Kg.
LAL0L300	ALOS 34W. LED 3000/930	>90	3000	PENDIENTE DE FABRICACION
LAL0L301	ALOS 34W. LED 3000/940	>90	4000	PENDIENTE DE FABRICACION
LAL0L400	ALOS 36W. LED 4000/930	>90	3000	PENDIENTE DE FABRICACION
LAL0L401	ALOS 38W. LED 4000/940	>90	4000	PENDIENTE DE FABRICACION





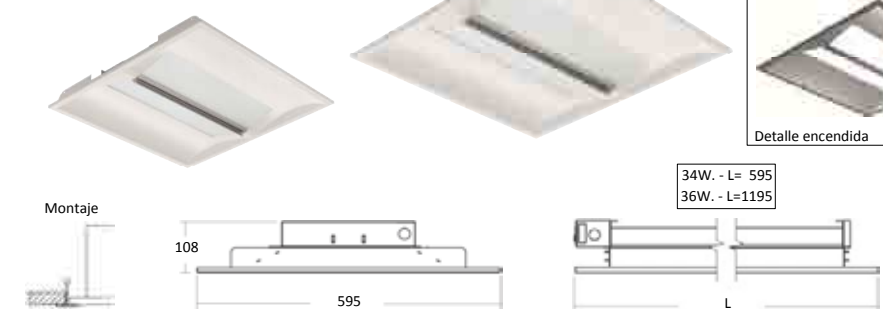





Equipo de control electrónico, bajo consulta equipo de control electrónico regulable (EE=A1 - DALI).



EMPOTRABLES



Materiales: Luminaria polivalente con cuerpo en chapa blanca de acero, difusor de aluminio láminas brillantes, embellecedor liso brillante.



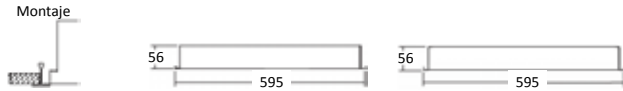

CODIGO	REFERENCIA	Indice rendimiento de color CRI (Ra)	Temperatura de color CCT (k)	P.V.P.	Kg.		
13211L440	T55/UL LED 2x19W. 4400lm/840	>80	4000	370,78 €	(3,8)		
13211L660	T55/UL LED 3x19W. 6600lm/840	>80	4000	504,01 €	(3,9)		
13211L880	T55/UL LED 4x19W. 8800lm/840	>80	4000	601,07 €	(4,0)		

Accesorios:

0092301047	ANCLAJES PARA TECHOS DE ESCAYOLA LISA (BAJO PEDIDO, JUEGO 4 UDS.)	5,52 €	---
------------	--	---------------	-----



Materiales: Luminaria polivalente con cuerpo en chapa blanca de acero, difusor plancha microprisma.





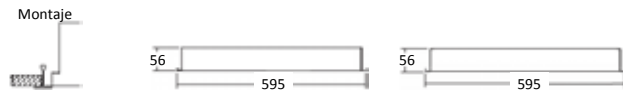

CODIGO	REFERENCIA	Indice rendimiento de color CRI (Ra)	Temperatura de color CCT (k)	P.V.P.	Kg.		
137270L500	T55/MICROPRISMA LED 4x12W. 5000lm/840	>80	4000	527,62 €	(3,8)		

Accesorios:

0092301047	ANCLAJES PARA TECHOS DE ESCAYOLA LISA (BAJO PEDIDO, JUEGO 4 UDS.)	5,52 €	---
------------	--	---------------	-----



Materiales: Cuerpo en chapa blanca de acero, reflector de aluminio, difusor PMMA opal.





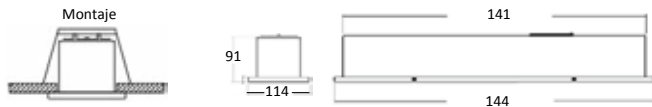

CODIGO	REFERENCIA	Indice rendimiento de color CRI (Ra)	Temperatura de color CCT (k)	P.V.P.	Kg.		
137256L455	T5-PTE/OPAL LED 59W. 4550lm/830	>80	3000	989,97 €	(3,9)		
137256L470	T5-PTE/OPAL LED 59W. 4700lm/840	>80	4000	989,97 €	(3,9)		

Accesorios:

0092301047	ANCLAJES PARA TECHOS DE ESCAYOLA LISA (BAJO PEDIDO, JUEGO 4 UDS.)	5,52 €	---
------------	--	---------------	-----



Materiales: Cuerpo en chapa blanca de acero, marco del difusor de aluminio extruido, difusor PMMA opal + PMMA microprisma.

CODIGO	REFERENCIA	Indice rendimiento de color CRI (Ra)	Temperatura de color CCT (k)	P.V.P.	Kg.		
1542323L330	PTE/OPALPC-IP65 LED-49W. 3300lm/830	>80	3000	1.150,38 €	(9,4)		
1542323L340	PTE/OPALPC-IP65 LED-49W. 3400lm/840	>80	4000	1.150,38 €	(9,4)		

Accesorios:



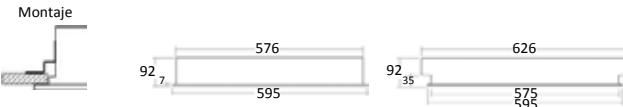

0092301047	ANCLAJES PARA TECHOS DE ESCAYOLA LISA (BAJO PEDIDO, JUEGO 4 UDS.)	5,52 €	---
------------	--	---------------	-----



EMPOTRABLES CON TUBOS



Materiales: Luminaria polivalente con cuerpo en chapa blanca de acero, difusor de aluminio parabólico brillante con transversales escalonadas.

CODIGO	REFERENCIA	Indice rendimiento de color CRI (Ra)	Temperatura de color CCT (k)	P.V.P.	Kg.		
1332802L411L	P/EXTL LED-4x10W. 3000lm/840	>80	4000	357,42 €	(2,5)		



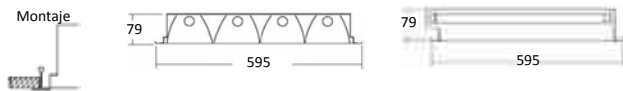

Accesorios:

009230101	ANCLAJES PARA TECHOS DE ESCAYOLA LISA (BAJO PEDIDO, JUEGO 4 UDS.)	5,52 €	---
-----------	--	---------------	-----

Tubos LED Philips incluidos.



Materiales: Luminaria polivalente con cuerpo en chapa blanca de acero, difusor plancha opal.

CODIGO	REFERENCIA	Indice rendimiento de color CRI (Ra)	Temperatura de color CCT (k)	P.V.P.	Kg.		
1332801L411L	POL/OPAL LED-4x10W. 3000lm/840	>80	4000	407,20 €	(4,2)		

Accesorios:

009230101	ANCLAJES PARA TECHOS DE ESCAYOLA LISA (BAJO PEDIDO, JUEGO 4 UDS.)	5,52 €	---
-----------	--	---------------	-----

Tubos LED Philips incluidos.

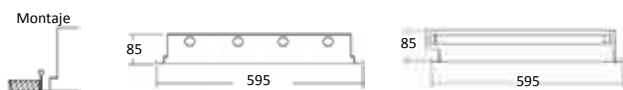

EMPOTRABLES T-5

Materiales: Luminaria polivalente en chapa de acero, difusor de aluminio doble parabólico brillante "T5NKB" o mate "T5NK".

CODIGO	REFERENCIA	P.V.P.	Kg.
1372623414L	T5NKB-4x14W. H.F. + TUBOS 840	93,95 €	(3,0)

Anclajes para techos de escayola lisa incluidos.

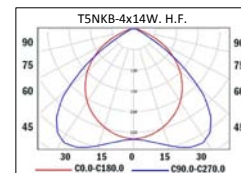
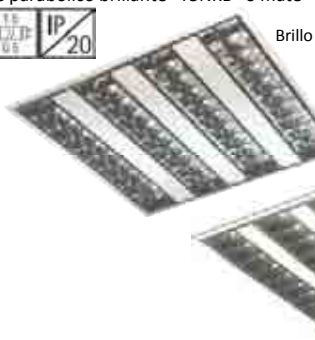
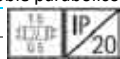

LOR= 72.00%

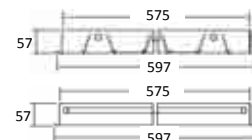

1372613414L	T5NK-4x14W. H.F. + TUBOS 840	93,95 €	(3,0)
-------------	------------------------------	---------	-------

Anclajes para techos de escayola lisa incluidos.

Materiales: Cuerpo en chapa de acero, difusor de aluminio doble parabólico brillante, embellecedor liso en color blanco. Techos Armstrong.

CODIGO	REFERENCIA	P.V.P.	Kg.
1372603314	T5N-3x14W. H.F.	133,74 €	(4,2)
1372603324	T5N-3x24W. H.F.	144,32 €	(4,2)
1372603414	T5N-4x14W. H.F.	146,70 €	(4,4)
1372603424	T5N-4x24W. H.F.	150,48 €	(4,4)

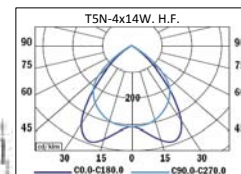
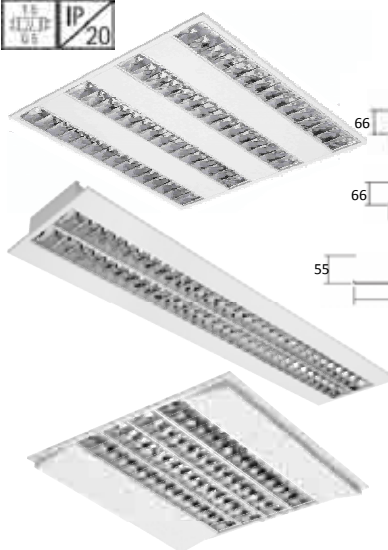
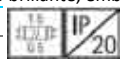

LOR= 61.00%

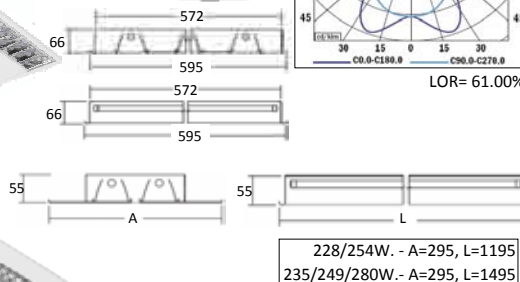

228/254W. - A=295, L=1195
235/249/280W. - A=295, L=1495

1372603228	T5N/C-2x28W. H.F.	143,75 €	(4,8)
1372603254	T5N/C-2x54W. H.F.	143,75 €	(4,8)
1372603235	T5N/C-2x35W. H.F.	150,13 €	(5,4)
1372603249	T5N/C-2x49W. H.F.	153,36 €	(5,4)
1372603280	T5N/C-2x80W. H.F.	174,69 €	(5,4)

137303314	T5-A-3x14W. H.F. (3 CENTRO)	206,15 €	(4,8)
137303324	T5-A-3x24W. H.F. (3 CENTRO)	242,36 €	(4,8)
137303414	T5-A-4x14W. H.F. (4 CENTRO)	215,03 €	(4,8)
137303424	T5-A-4x24W. H.F. (4 CENTRO)	251,23 €	(4,8)

Accesorios: Recuperadores de flujo bajo consulta.

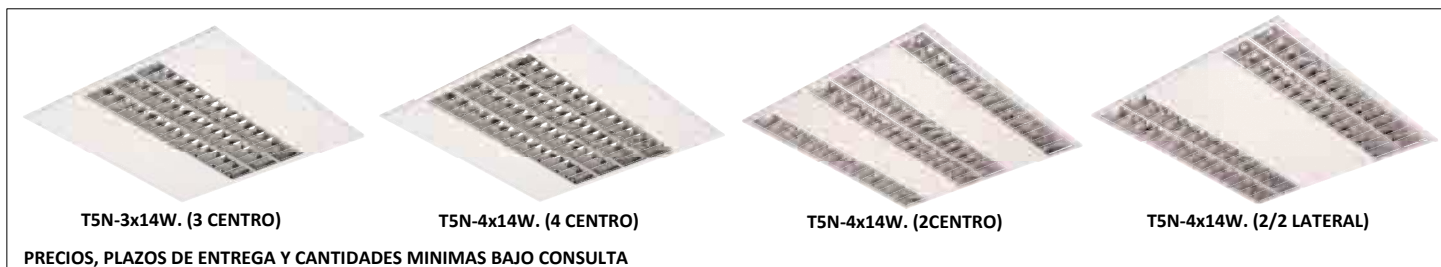

PRECIOS, PLAZOS DE ENTREGA Y CANTIDADES MINIMAS BAJO CONSULTA

Materiales: Cuerpo en chapa de acero, difusor de aluminio doble parabólico brillante, embellecedor microperforado. Techos Armstrong.

CODIGO	REFERENCIA	P.V.P.	Kg.
156202804314	T5N/MICRO-3x14W. H.F.	150,49 €	(4,6)
156202804324	T5N/MICRO-3x24W. H.F.	183,84 €	(4,6)
156202804414	T5N/MICRO-4x14W. H.F.	160,95 €	(4,5)
156202804424	T5N/MICRO-4x24W. H.F.	188,07 €	(4,5)

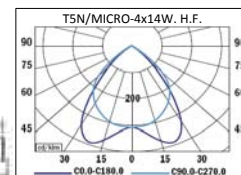
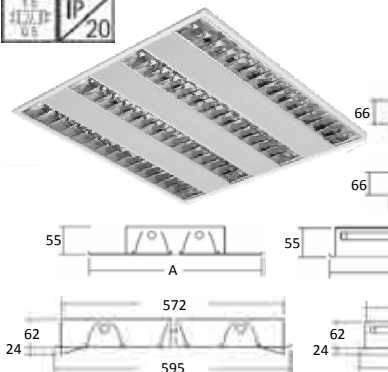
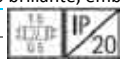

LOR= 61.00%

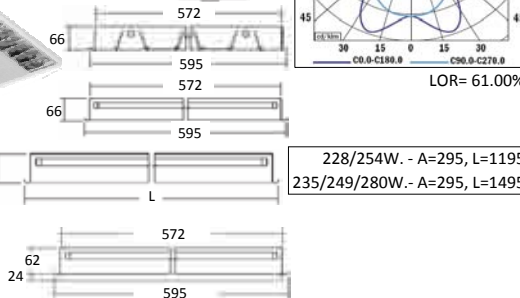

228/254W. - A=295, L=1195
235/249/280W. - A=295, L=1495

156202804228	T5N/MICRO-2x28W. H.F.	180,49 €	(4,9)
156202804254	T5N/MICRO-2x54W. H.F.	180,49 €	(4,9)

137313314	T5-A/MICRO-3x14W. H.F. (3 CENTRO)	249,47 €	(4,8)
137303324	T5-A/MICRO-3x24W. H.F. (3 CENTRO)	285,67 €	(4,8)
137303414	T5-A/MICRO-4x14W. H.F. (4 CENTRO)	258,35 €	(4,8)
137303424	T5-A/MICRO-4x24W. H.F. (4 CENTRO)	294,55 €	(4,8)

Accesorios: Recuperadores de flujo bajo consulta.

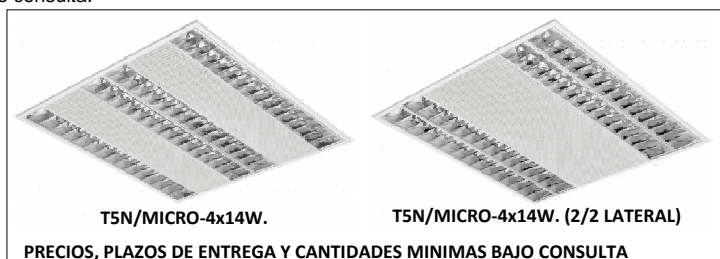

PRECIOS, PLAZOS DE ENTREGA Y CANTIDADES MINIMAS BAJO CONSULTA

EMPOTRABLES T-5

Materiales: Cuerpo en chapa de acero, difusor de aluminio doble parabólico brillante, embellecedor liso en color blanco. Techos escayola lisa.

CODIGO	REFERENCIA	P.V.P.	Kg.
13726003314	T5N-PTE-3x14W. H.F.	143,42 €	(4,6)
156202804324	T5N-PTE-3x24W. H.F.	179,62 €	(4,6)
156202804414	T5N-PTE-4x14W. H.F.	160,27 €	(4,6)
156202804424	T5N-PTE-4x24W. H.F.	183,84 €	(4,6)

Accesorios: Recuperadores de flujo bajo consulta.

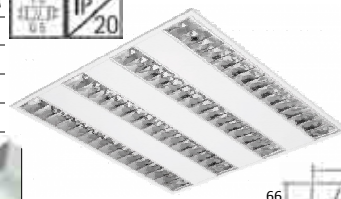

Montaje

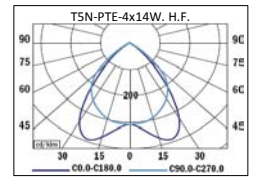

LOR = 61.00%

Materiales: Cuerpo en chapa de acero, difusor de aluminio doble parabólico brillante, embellecedor microperforado. Techos escayola lisa.

CODIGO	REFERENCIA	P.V.P.	Kg.
156202800314	T5N/MICRO-PTE-3x14W. H.F.	164,25 €	(4,6)
156202800324	T5N/MICRO-PTE-3x24W. H.F.	192,29 €	(4,6)
156202800414	T5N/MICRO-PTE-4x14W. H.F.	174,71 €	(4,6)
156202800424	T5N/MICRO-PTE-4x24W. H.F.	196,52 €	(4,6)

Accesorios: Recuperadores de flujo bajo consulta.

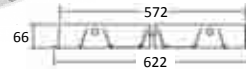
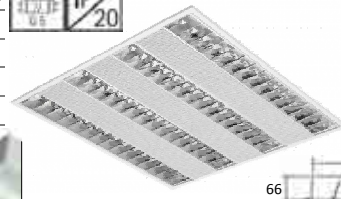

Montaje

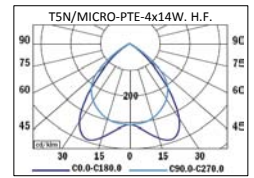

LOR = 61.00%

Materiales: Cuerpo en chapa de acero, difusor de aluminio doble parabólico brillante. Techos armstrong.

CODIGO	REFERENCIA	P.V.P.	Kg.
1372013214	T5/BR-2x14W. H.F.	116,94 €	(2,0)
1372013224	T5/BR-2x24W. H.F.	116,94 €	(2,0)
1372013414	T5/BR-4x14W. H.F.	148,88 €	(4,0)
1372013424	T5/BR-4x24W. H.F.	187,86 €	(4,0)
1372013228	T5/BR-2x28W. H.F.	166,22 €	(4,4)
1372013254	T5/BR-2x54W. H.F.	166,22 €	(4,4)

214/224W. - A= 295, L= 595, X=256, Y= 615
 414/424W. - A= 595, L= 595, X=557, Y= 575
 228/254W. - A= 295, L=1195, X=256, Y=1223

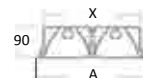

Montaje

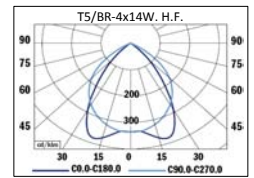

LOR = 73.38%

Materiales: Cuerpo en chapa de acero, difusor de aluminio doble parabólico brillante. Techos escayola lisa.

CODIGO	REFERENCIA	P.V.P.	Kg.
1372513414	T5-PTE/BR-4x14W. H.F.	157,98 €	(4,8)
1372513424	T5-PTE/BR-4x24W. H.F.	196,97 €	(4,8)

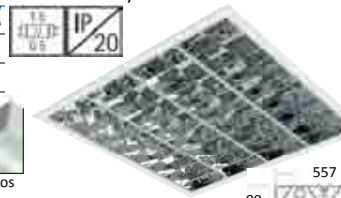

Montaje

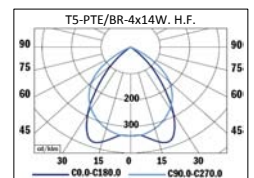

LOR = 73.38%

Materiales: Cuerpo en chapa de acero, difusor de aluminio doble parabólico mate. Techos armstrong.

CODIGO	REFERENCIA	P.V.P.	Kg.
1372014214	T5/MR-2x14W. H.F.	121,87 €	(2,0)
1372014224	T5/MR-2x24W. H.F.	121,87 €	(2,0)
1372014414	T5/MR-4x14W. H.F.	162,53 €	(4,0)
1372014424	T5/MR-4x24W. H.F.	201,52 €	(4,0)
1372014228	T5/MR-2x28W. H.F.	181,00 €	(4,4)
1372014254	T5/MR-2x54W. H.F.	181,00 €	(4,4)

214/224W. - A= 295, L= 595, X=256, Y= 615
 414/424W. - A= 595, L= 595, X=557, Y= 575
 228/254W. - A= 295, L=1195, X=256, Y=1223

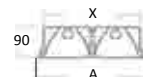

Montaje

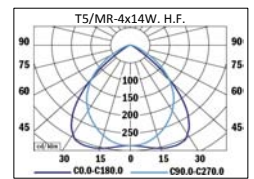

LOR = 55.01%

Materiales: Cuerpo en chapa de acero, difusor de aluminio doble parabólico mate. Techos escayola lisa.

CODIGO	REFERENCIA	P.V.P.	Kg.
1372514414	T5-PTE/MR-4x14W. H.F.	171,63 €	(4,8)
1372514424	T5-PTE/MR-4x24W. H.F.	210,61 €	(4,8)

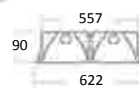
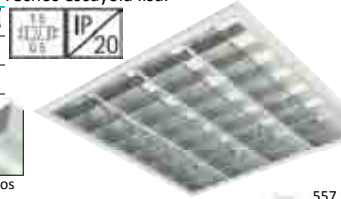

Montaje

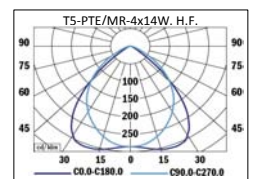

LOR = 55.01%

EMPOTRABLES T-5

Materiales: Cuerpo en chapa de acero, difusor plancha prisma. Techos armstrong.

CODIGO	REFERENCIA	P.V.P.	Kg.	15 40/20 GS	IP 40
1380703214	T5/PRISMA-2x14W. H.F.	102,33 €	(2,6)		
1380703224	T5/PRISMA-2x24W. H.F.	102,33 €	(2,6)		
1380703414	T5/PRISMA-4x14W. H.F.	128,70 €	(4,6)		
1380703424	T5/PRISMA-4x24W. H.F.	159,41 €	(4,6)		
1380703228	T5/PRISMA-2x28W. H.F.	151,44 €	(4,8)		
1380703254	T5/PRISMA-2x54W. H.F.	151,44 €	(4,8)		

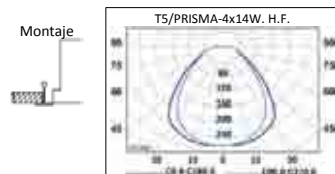

LOR= 61.98%

214/224W. - A= 295, L= 595, X=256, Y= 615
414/424W. - A= 595, L= 595, X=557, Y= 575
228/254W. - A= 295, L=1195, X=256, Y=1223

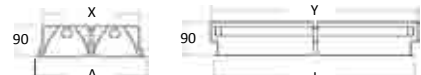

Materiales: Cuerpo en chapa de acero, difusor plancha opal. Techos armstrong.

CODIGO	REFERENCIA	P.V.P.	Kg.	15 40/20 GS	IP 40
1380803214	T5/OPAL-2x14W. H.F.	112,02 €	(2,6)		
1380803224	T5/OPAL-2x24W. H.F.	112,02 €	(2,6)		
1380803414	T5/OPAL-4x14W. H.F.	147,33 €	(4,6)		
1380803424	T5/OPAL-4x24W. H.F.	178,89 €	(4,6)		
1380803228	T5/OPAL-2x28W. H.F.	171,15 €	(4,8)		
1380803254	T5/OPAL-2x54W. H.F.	171,15 €	(4,8)		

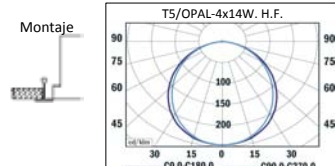

LOR= 65.78%

214/224W. - A= 295, L= 595, X=256, Y= 615
414/424W. - A= 595, L= 595, X=557, Y= 575
228/254W. - A= 295, L=1195, X=256, Y=1223

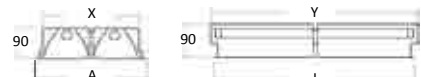

POLIVALENTES T-5 | SECCION REDUCIDA

Materiales: Cuerpo en chapa de acero, difusor de aluminio laminas brillantes, embellecedor microperforado en color blanco.

CODIGO	REFERENCIA	P.V.P.	Kg.	15 40/20 GS	IP 20
1372103428	T55/UM-4x28W. H.F.	299,69 €	(6,3)	1175x575	
1372103328	T55/UM-3x28W. H.F.	260,25 €	(6,5)	1175x575	
1372103424	T55/UM-4x24W. H.F.	183,54 €	(4,2)	575x575	
1372103324	T55/UM-3x24W. H.F.	164,89 €	(4,2)	575x575	
1372103414	T55/UM-4x14W. H.F.	184,19 €	(4,2)	575x575	
1372103314	T55/UM-3x14W. H.F.	165,29 €	(4,2)	575x575	
1372103228	T55/UM-2x28W. H.F.	160,90 €	(4,2)	1175x275	



428/328W. - A= 595, L=1195
314/324/414/424W. - A= 595, L= 595
228W. - A= 295, L=1195

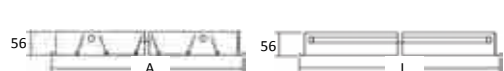

Accesorios:

0092301047	ANCLAJES PARA TECHOS DE ESCAYOLA LISA (BAJO PEDIDO, JUEGO 4 UDS.)	5,52 €	---
------------	---	--------	-----

Materiales: Cuerpo en chapa de acero, difusor de aluminio laminas satinadas mate, embellecedor microperforado en color blanco.

CODIGO	REFERENCIA	P.V.P.	Kg.	15 40/20 GS	IP 20
137253428	T55/UMM-4x28W. H.F.	316,58 €	(6,3)	1175x575	
137253328	T55/UMM-3x28W. H.F.	276,85 €	(6,5)	1175x575	
137253424	T55/UMM-4x24W. H.F.	232,17 €	(4,2)	575x575	
137253324	T55/UMM-3x24W. H.F.	177,35 €	(4,2)	575x575	
137253414	T55/UMM-4x14W. H.F.	230,66 €	(4,2)	575x575	
137253314	T55/UMM-3x14W. H.F.	177,92 €	(4,2)	575x575	
137253228	T55/UMM-2x28W. H.F.	174,25 €	(4,2)	1175x275	

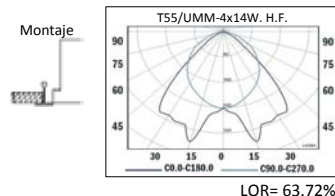

LOR= 63.72%

428/328W. - A= 595, L=1195
314/324/414/424W. - A= 595, L= 595
228W. - A= 295, L=1195



Accesorios:

0092301047	ANCLAJES PARA TECHOS DE ESCAYOLA LISA (BAJO PEDIDO, JUEGO 4 UDS.)	5,52 €	---
------------	---	--------	-----

Materiales: Cuerpo en chapa de acero, difusor de aluminio doble parabólico brillante, embellecedor microperforado en color blanco.

CODIGO	REFERENCIA	P.V.P.	Kg.	15 40/20 GS	IP 20
137233428	T55/UMBR-4x28W. H.F.	332,08 €	(6,3)	1175x575	
137233428	T55/UMBR-3x28W. H.F.	287,21 €	(6,5)	1175x575	
137233428	T55/UMBR-4x24W. H.F.	200,36 €	(4,2)	575x575	
137233428	T55/UMBR-3x24W. H.F.	177,54 €	(4,2)	575x575	
137233428	T55/UMBR-4x14W. H.F.	201,24 €	(4,2)	575x575	
137233428	T55/UMBR-3x14W. H.F.	178,11 €	(4,2)	575x575	
137233428	T55/UMBR-2x28W. H.F.	175,09 €	(4,2)	1175x275	

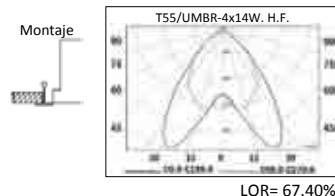

LOR= 67.40%

428/328W. - A= 595, L=1195
314/324/414/424W. - A= 595, L= 595
228W. - A= 295, L=1195

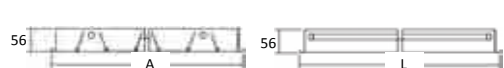

Accesorios:

0092301047	ANCLAJES PARA TECHOS DE ESCAYOLA LISA (BAJO PEDIDO, JUEGO 4 UDS.)	5,52 €	---
------------	---	--------	-----

Materiales: Cuerpo en chapa de acero, difusor de aluminio doble parabólico satinado mate, embellecedor microperforado en color blanco.

CODIGO	REFERENCIA	P.V.P.	Kg.	15 40/20 GS	IP 20
137243428	T55/UMMR-4x28W. H.F.	372,82 €	(6,3)	1175x575	
137243328	T55/UMMR-3x28W. H.F.	318,18 €	(6,5)	1175x575	
137243424	T55/UMMR-4x24W. H.F.	222,36 €	(4,2)	575x575	
137243324	T55/UMMR-3x24W. H.F.	194,62 €	(4,2)	575x575	
137243414	T55/UMMR-4x14W. H.F.	223,53 €	(4,2)	575x575	
137243314	T55/UMMR-3x14W. H.F.	195,43 €	(4,2)	575x575	
137243228	T55/UMMR-2x28W. H.F.	192,40 €	(4,2)	1175x275	

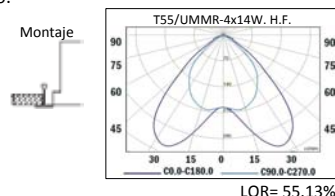

LOR= 55.13%

428/328W. - A= 595, L=1195
314/324/414/424W. - A= 595, L= 595
228W. - A= 295, L=1195

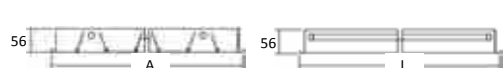

Accesorios:

0092301047	ANCLAJES PARA TECHOS DE ESCAYOLA LISA (BAJO PEDIDO, JUEGO 4 UDS.)	5,52 €	---
------------	---	--------	-----

POLIVALENTES T-5 SECCION REDUCIDA

Materiales: Cuerpo en chapa de acero, difusor de aluminio doble parabólico brillante, embellecedor liso brillante.

CODIGO	REFERENCIA	P.V.P.	Kg.
1372123428	T55/ULBR-4x28W. H.F.	298,26 €	(6,0) 1175x575
1372123328	T55/ULBR-3x28W. H.F.	261,34 €	(6,1) 1175x575
1372123424	T55/ULBR-4x24W. H.F.	181,88 €	(3,8) 575x575
1372123324	T55/ULBR-3x24W. H.F.	161,66 €	(3,8) 575x575
1372123414	T55/ULBR-4x14W. H.F.	182,52 €	(3,8) 575x575
1372123314	T55/ULBR-3x14W. H.F.	162,02 €	(3,8) 575x575
1372123228	T55/ULBR-2x28W. H.F.	167,52 €	(3,8) 1175x275

Accesorios:

0092301047	ANCLAJES PARA TECHOS DE ESCAYOLA LISA (BAJO PEDIDO, JUEGO 4 UDS.)	5,52 €	---
------------	---	--------	-----



428/328W. - A= 595, L=1195
314/324/414/424W. - A= 595, L= 595
228W. - A= 295, L=1195

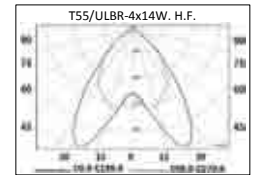
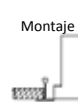

LOR= 67.40%



Materiales: Cuerpo en chapa de acero, difusor de aluminio doble parabólico brillante, embellecedor liso brillante.

CODIGO	REFERENCIA	P.V.P.	Kg.
1372133428	T55/ULMR-4x28W. H.F.	343,83 €	(6,0) 1175x575
1372133328	T55/ULMR-3x28W. H.F.	306,51 €	(6,1) 1175x575
1372133424	T55/ULMR-4x24W. H.F.	209,18 €	(3,8) 575x575
1372133324	T55/ULMR-3x24W. H.F.	185,61 €	(3,8) 575x575
1372133414	T55/ULMR-4x14W. H.F.	210,18 €	(3,8) 575x575
1372133314	T55/ULMR-3x14W. H.F.	186,29 €	(3,8) 575x575
1372133228	T55/ULMR-2x28W. H.F.	193,43 €	(3,8) 1175x275

Accesorios:

0092301047	ANCLAJES PARA TECHOS DE ESCAYOLA LISA (BAJO PEDIDO, JUEGO 4 UDS.)	5,52 €	---
------------	---	--------	-----



428/328W. - A= 595, L=1195
314/324/414/424W. - A= 595, L= 595
228W. - A= 295, L=1195

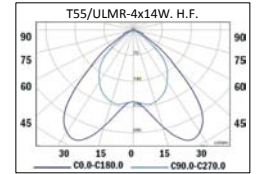
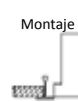

LOR= 55.13%



Materiales: Cuerpo en chapa de acero, difusor de aluminio láminas brillantes, embellecedor liso brillante.

CODIGO	REFERENCIA	P.V.P.	Kg.
1372113428	T55/UL-4x28W. H.F.	281,12 €	(6,0) 1175x575
1372113328	T55/UL-3x28W. H.F.	236,46 €	(6,1) 1175x575
1372113424	T55/UL-4x24W. H.F.	165,06 €	(3,8) 575x575
1372113324	T55/UL-3x24W. H.F.	149,01 €	(3,8) 575x575
1372113414	T55/UL-4x14W. H.F.	165,47 €	(3,8) 575x575
1372113314	T55/UL-3x14W. H.F.	149,19 €	(3,8) 575x575
1372113228	T55/UL-2x28W. H.F.	145,87 €	(3,8) 1175x275

Accesorios:

0092301047	ANCLAJES PARA TECHOS DE ESCAYOLA LISA (BAJO PEDIDO, JUEGO 4 UDS.)	5,52 €	---
------------	---	--------	-----



428/328W. - A= 595, L=1195
314/324/414/424W. - A= 595, L= 595
228W. - A= 295, L=1195

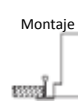

LOR= 63.72%



Materiales: Cuerpo en chapa de acero, difusor de aluminio láminas satinadas mate, embellecedor liso satinado mate.

CODIGO	REFERENCIA	P.V.P.	Kg.
1372025428	T55/ULM-4x28W. H.F.	303,76 €	(6,0) 1175x575
1372025328	T55/ULM-3x28W. H.F.	259,10 €	(6,1) 1175x575
1372025424	T55/ULM-4x24W. H.F.	186,31 €	(3,8) 575x575
1372025324	T55/ULM-3x24W. H.F.	168,34 €	(3,8) 575x575
1372025414	T55/ULM-4x14W. H.F.	187,01 €	(3,8) 575x575
1372025314	T55/ULM-3x14W. H.F.	168,79 €	(3,8) 575x575
1372025228	T55/ULM-2x28W. H.F.	166,03 €	(3,8) 1175x275

Accesorios:

0092301047	ANCLAJES PARA TECHOS DE ESCAYOLA LISA (BAJO PEDIDO, JUEGO 4 UDS.)	5,52 €	---
------------	---	--------	-----



428/328W. - A= 595, L=1195
314/324/414/424W. - A= 595, L= 595
228W. - A= 295, L=1195

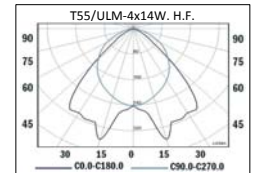
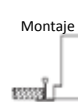

LOR= 61.98%



Materiales: Cuerpo en chapa de acero, difusor plancha prisma.

CODIGO	REFERENCIA	P.V.P.	Kg.
1372703428	T55/PRISMA-4x28W. H.F.	205,48 €	(6,0) 1175x575
1372703328	T55/PRISMA-3x28W. H.F.	198,96 €	(6,1) 1175x575
1372703424	T55/PRISMA-4x24W. H.F.	137,06 €	(3,8) 575x575
1372703324	T55/PRISMA-3x24W. H.F.	134,03 €	(3,8) 575x575
1372703414	T55/PRISMA-4x14W. H.F.	135,25 €	(3,8) 575x575
1372703314	T55/PRISMA-3x14W. H.F.	132,22 €	(3,8) 575x575
1372703228	T55/PRISMA-2x28W. H.F.	123,57 €	(3,8) 1175x275

Accesorios:

0092301047	ANCLAJES PARA TECHOS DE ESCAYOLA LISA (BAJO PEDIDO, JUEGO 4 UDS.)	5,52 €	---
------------	---	--------	-----



428/328W. - A= 595, L=1195
314/324/414/424W. - A= 595, L= 595
228W. - A= 295, L=1195

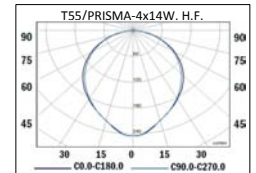
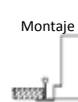

LOR= 61.98%



Materiales: Cuerpo en chapa de acero, difusor aluminio láminas brillantes, embellecedor liso esmaltado en color blanco.

CODIGO	REFERENCIA	P.V.P.	Kg.
1370003428	T55/UB-4x28W. H.F.	236,19 €	(6,0) 1175x575
1370003328	T55/UB-3x28W. H.F.	211,61 €	(6,1) 1175x575
1370003424	T55/UB-4x24W. H.F.	152,60 €	(3,8) 575x575
1370003324	T55/UB-3x24W. H.F.	138,42 €	(3,8) 575x575
1370003414	T55/UB-4x14W. H.F.	150,80 €	(3,8) 575x575
1370003314	T55/UB-3x14W. H.F.	136,62 €	(3,8) 575x575
1370003228	T55/UB-2x28W. H.F.	134,27 €	(3,8) 1175x275

Accesorios:

0092301047	ANCLAJES PARA TECHOS DE ESCAYOLA LISA (BAJO PEDIDO, JUEGO 4 UDS.)	5,52 €	---
------------	---	--------	-----



428/328W. - A= 595, L=1195
314/324/414/424W. - A= 595, L= 595
228W. - A= 295, L=1195



LOR= 61.98%



EMPOTRABLES T-8

Materiales: Cuerpo en chapa de acero, difusor de aluminio parabólico brillante con transversales escalonadas. Luminaria polivalente.

CODIGO	REFERENCIA	P.V.P.	Kg.	IP
13328022418	P/EXTL-4x18W. 230V. A.F.	51,86 €	(4,0)	580x580
13328023418	P/EXTL-4x18W. H.F.	81,03 €	(3,2)	580x580
009230101	ANCLAJES PARA TECHOS DE ESCAYOLA LISA (BAJO PEDIDO, JUEGO 4 UDS.)	5,52 €	---	

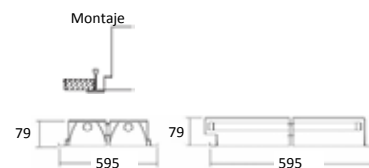
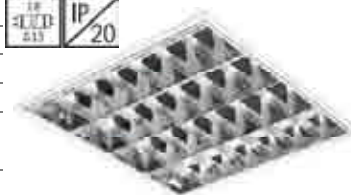

Materiales: Cuerpo en chapa de acero, difusor de aluminio parabólico brillante con transversales escalonadas. Techos armstrong.

CODIGO	REFERENCIA	P.V.P.	Kg.	IP
13328001418	P/EXT-4x18W. 230V. B.F.	73,16 €	(4,6)	
13328002436	P/EXT-4x36W. 230V. A.F.	142,41 €	(9,1)	
13328002336	P/EXT-3x36W. 230V. A.F.	125,17 €	(9,1)	
13328002236	P/EXT-2x36W. 230V. A.F.	77,52 €	(4,8)	
13328002318	P/EXT-3x18W. 230V. A.F.	72,23 €	(5,4)	
13328002218	P/EXT-2x18W. 230V. A.F.	48,94 €	(2,7)	
13328002418	P/EXT-4x18W. 230V. A.F.	74,87 €	(4,7)	
13328003436	P/EXT-4x36W. H.F.	177,78 €	(7,4)	
13328003336	P/EXT-3x36W. H.F.	165,86 €	(7,4)	
13328003236	P/EXT-2x36W. H.F.	94,38 €	(4,2)	
13328003318	P/EXT-3x18W. H.F.	92,66 €	(4,1)	
13328003218	P/EXT-2x18W. H.F.	74,03 €	(2,1)	
13328003418	P/EXT-4x18W. H.F.	84,85 €	(4,1)	

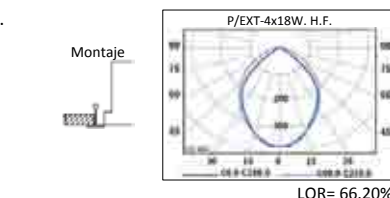
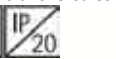

336/436W. - A= 595, L=1195, H=92
 236W. - A= 295, L=1195, H=82
 318W. - A= 595, L= 595, H=80
 418W. - A= 595, L= 595, H=80
 218W. - A= 295, L= 595, H=82



Materiales: Cuerpo en chapa de acero, difusor de aluminio parabólico brillante con transversales escalonadas. Techos escayola lisa.

CODIGO	REFERENCIA	P.V.P.	Kg.	IP
13328102436	PTE/EXT-4x36W. 230V. A.F.	147,87 €	(9,5)	1185x585
13328102336	PTE/EXT-3x36W. 230V. A.F.	132,86 €	(9,5)	1185x585
13328102236	PTE/EXT-2x36W. 230V. A.F.	82,63 €	(5,8)	1180x285
13328102318	PTE/EXT-3x18W. 230V. A.F.	95,11 €	(5,6)	605x585
13328102218	PTE/EXT-2x18W. 230V. A.F.	56,82 €	(2,9)	285x285
13328102418	PTE/EXT-4x18W. 230V. A.F.	80,74 €	(4,9)	605x585
13328103436	PTE/EXT-4x36W. H.F.	183,27 €	(7,8)	1185x585
13328103336	PTE/EXT-3x36W. H.F.	171,36 €	(7,8)	1185x585
13328103236	PTE/EXT-2x36W. H.F.	99,46 €	(5,2)	1180x285
13328103318	PTE/EXT-3x18W. H.F.	107,32 €	(4,3)	605x585
13328103218	PTE/EXT-2x18W. H.F.	79,57 €	(2,3)	285x285
13328103418	PTE/EXT-4x18W. H.F.	102,14 €	(4,3)	605x585

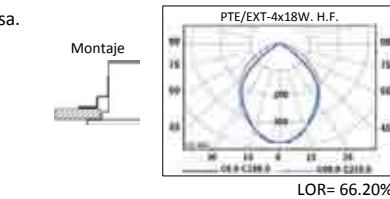
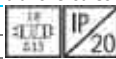

336/436W. - A= 620, L=1220, H=92
 236W. - A= 320, L=1220, H=90
 318W. - A= 622, L= 622, H=92
 418W. - A= 622, L= 622, H=72
 218W. - A= 320, L= 620, H=82



Materiales: Cuerpo en chapa de acero, difusor de aluminio parabólico esmaltado en blanco con transversales escalonadas. Techos armstrong.

CODIGO	REFERENCIA	P.V.P.	Kg.	IP
13327002436	P/LV-4x36W. 230V. A.F.	144,30 €	(9,1)	
13327002336	P/LV-3x36W. 230V. A.F.	126,68 €	(9,1)	
13327002236	P/LV-2x36W. 230V. A.F.	78,86 €	(4,8)	
13327002318	P/LV-3x18W. 230V. A.F.	72,61 €	(5,4)	
13327002218	P/LV-2x18W. 230V. A.F.	52,52 €	(2,7)	
13327002418	P/LV-4x18W. 230V. A.F.	76,38 €	(4,7)	
13327003436	P/LV-4x36W. H.F.	179,70 €	(7,4)	
13327003336	P/LV-3x36W. H.F.	166,07 €	(7,4)	
13327003236	P/LV-2x36W. H.F.	95,89 €	(4,2)	
13327003318	P/LV-3x18W. H.F.	93,79 €	(4,1)	
1332700218	P/LV-2x18W. H.F.	76,62 €	(2,1)	
1332700418	P/LV-4x18W. H.F.	97,95 €	(4,1)	

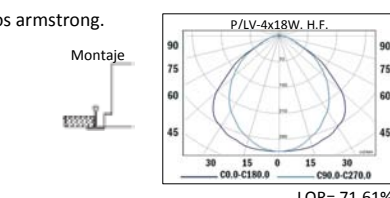
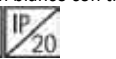

336/436W. - A= 595, L=1195, H=92
 236W. - A= 295, L=1195, H=82
 318W. - A= 595, L= 595, H=80
 418W. - A= 595, L= 595, H=80
 218W. - A= 295, L= 595, H=82



Materiales: Cuerpo en chapa de acero, difusor de aluminio parabólico esmaltado en blanco con transversales escalonadas. Techos escayola lisa.

CODIGO	REFERENCIA	P.V.P.	Kg.	IP
13327102436	PTE/LV-4x36W. 230V. A.F.	151,68 €	(9,5)	1185x585
13327102336	PTE/LV-3x36W. 230V. A.F.	138,41 €	(9,5)	1185x585
13327102236	PTE/LV-2x36W. 230V. A.F.	83,94 €	(5,8)	1180x285
13327102318	PTE/LV-3x18W. 230V. A.F.	98,40 €	(5,6)	605x585
13327102218	PTE/LV-2x18W. 230V. A.F.	58,98 €	(2,9)	285x285
13327102418	PTE/LV-4x18W. 230V. A.F.	82,26 €	(4,9)	605x585
13327103436	PTE/LV-4x36W. H.F.	185,16 €	(7,8)	1185x585
13327103336	PTE/LV-3x36W. H.F.	173,83 €	(7,8)	1185x585
13327103236	PTE/LV-2x36W. H.F.	100,80 €	(5,2)	1180x285
13327103318	PTE/LV-3x18W. H.F.	114,84 €	(4,3)	605x585
13327103218	PTE/LV-2x18W. H.F.	81,35 €	(2,3)	285x285
13327103418	PTE/LV-4x18W. H.F.	103,44 €	(4,3)	605x585

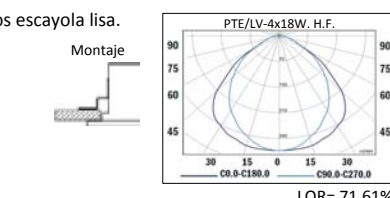

336/436W. - A= 620, L=1220, H=92
 236W. - A= 320, L=1220, H=90
 318W. - A= 622, L= 622, H=92
 418W. - A= 622, L= 622, H=72
 218W. - A= 320, L= 620, H=82



EMPOTRABLES T-8

Materiales: Cuerpo en chapa de acero, difusor de aluminio doble parabólico brillante. Luminaria polivalente.

CODIGO	REFERENCIA	P.V.P.	Kg.	IP
13329022418	P/BRL-4x18W. 230V. A.F.	64,93 €	(4,0)	580x580
13329023418	P/BRL-4x18W. H.F.	93,86 €	(3,2)	580x580
009230101	ANCLAJES PARA TECHOS DE ESCAYOLA LISA (BAJO PEDIDO, JUEGO 4 UDS.)	5,52 €	---	

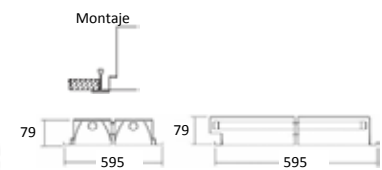

Materiales: Cuerpo en chapa de acero, difusor de aluminio doble parabólico brillante. Techos armstrong.

CODIGO	REFERENCIA	P.V.P.	Kg.	IP
13329002436	P/BR-4x36W. 230V. A.F.	176,16 €	(9,5)	1185x585
13329002336	P/BR-3x36W. 230V. A.F.	154,05 €	(9,5)	1185x585
13329002236	P/BR-2x36W. 230V. A.F.	94,29 €	(5,0)	1180x285
13329002318	P/BR-3x18W. 230V. A.F.	89,29 €	(5,3)	605x585
13329002218	P/BR-2x18W. 230V. A.F.	55,10 €	(3,0)	285x285
13329003436	P/BR-4x36W. H.F.	214,87 €	(7,8)	1185x585
13329003336	P/BR-3x36W. H.F.	198,54 €	(7,8)	1185x585
13329003236	P/BR-2x36W. H.F.	112,91 €	(4,4)	1180x285
13329003318	P/BR-3x18W. H.F.	111,67 €	(4,1)	605x585
13329003218	P/BR-2x18W. H.F.	78,34 €	(4,1)	285x285
13329013418	P/BRC-4x18W. H.F.	97,03 €	(4,4)	605x585

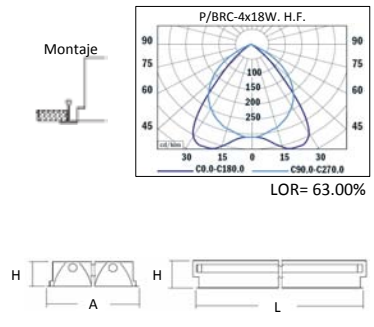

336/436W. - A= 595, L=1195, H=92
 236W. - A= 295, L=1195, H=82
 318W. - A= 595, L= 595, H=92
 418W. - A= 595, L= 595, H=92
 218W. - A= 295, L= 595, H=82

Materiales: Cuerpo en chapa de acero, difusor de aluminio doble parabólico brillante. Techos escayola lisa.

CODIGO	REFERENCIA	P.V.P.	Kg.	IP
13329102436	PTE/BR-4x36W. 230V. A.F.	181,98 €	(10,0)	1185x585
13329102336	PTE/BR-3x36W. 230V. A.F.	162,09 €	(10,0)	1185x585
13329102236	PTE/BR-2x36W. 230V. A.F.	99,84 €	(6,1)	1180x285
13329102318	PTE/BR-3x18W. 230V. A.F.	105,44 €	(5,8)	605x585
13329102218	PTE/BR-2x18W. 230V. A.F.	62,60 €	(3,2)	285x285
13329102418	PTE/BR-4x18W. 230V. A.F.	100,07 €	(5,2)	605x585
13329103436	PTE/BR-4x36W. H.F.	221,70 €	(8,3)	1185x585
13329103336	PTE/BR-3x36W. H.F.	204,54 €	(8,3)	1185x585
13329103236	PTE/BR-2x36W. H.F.	118,28 €	(5,5)	1180x285
13329103318	PTE/BR-3x18W. H.F.	119,38 €	(4,5)	605x585
13329103218	PTE/BR-2x18W. H.F.	84,94 €	(2,6)	285x285
13329103418	PTE/BR-4x18W. H.F.	123,46 €	(4,6)	605x585

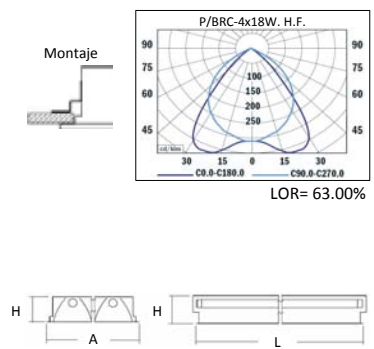

336/436W. - A= 622, L=1220, H=92
 236W. - A= 320, L=1220, H=92
 318W. - A= 622, L= 622, H=92
 418W. - A= 622, L= 622, H=92
 218W. - A= 320, L= 620, H=82

Materiales: Cuerpo en chapa de acero, difusor de aluminio doble parabólico mate. Techos armstrong.

CODIGO	REFERENCIA	P.V.P.	Kg.	IP
13325002436	P/MR-4x36W. 230V. A.F.	200,19 €	(9,5)	1185x585
13325002336	P/MR-3x36W. 230V. A.F.	174,51 €	(9,5)	1185x585
13325002236	P/MR-2x36W. 230V. A.F.	99,24 €	(5,0)	1180x285
13325002436	P/MR-3x18W. 230V. A.F.	99,84 €	(5,3)	605x585
13325002218	P/MR-2x18W. 230V. A.F.	60,91 €	(3,0)	285x285
13325002418	P/MR-4x18W. 230V. A.F.	104,84 €	(5,0)	605x585
13325003436	P/MR-4x36W. H.F.	236,83 €	(7,8)	1185x585
13325003336	P/MR-3x36W. H.F.	217,57 €	(7,8)	1185x585
13325003236	P/MR-2x36W. H.F.	120,98 €	(4,4)	1180x285
13325003436	P/MR-3x18W. H.F.	121,39 €	(4,1)	605x585
13325003218	P/MR-2x18W. H.F.	84,80 €	(2,4)	285x285
13325003418	P/MR-4x18W. H.F.	128,42 €	(4,4)	605x585

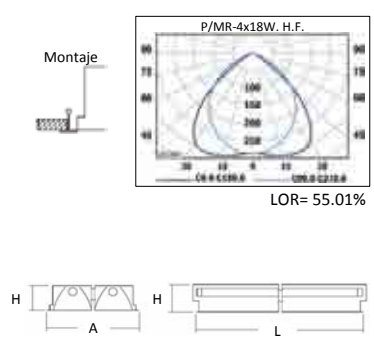

336/436W. - A= 595, L=1195, H=92
 236W. - A= 295, L=1195, H=82
 318W. - A= 595, L= 595, H=92
 418W. - A= 595, L= 595, H=92
 218W. - A= 295, L= 595, H=82

Materiales: Cuerpo en chapa de acero, difusor de aluminio doble parabólico mate. Techos escayola lisa.

CODIGO	REFERENCIA	P.V.P.	Kg.	IP
13325102436	PTE/MR-4x36W. 230V. A.F.	204,13 €	(10,0)	1185x585
13325102336	PTE/MR-3x36W. 230V. A.F.	179,09 €	(10,0)	1185x585
13325102236	PTE/MR-2x36W. 230V. A.F.	113,10 €	(6,1)	1180x285
13325102318	PTE/MR-3x18W. 230V. A.F.	118,28 €	(5,8)	605x585
13325102218	PTE/MR-2x18W. 230V. A.F.	67,37 €	(3,2)	285x285
13325102418	PTE/MR-4x18W. 230V. A.F.	111,26 €	(5,2)	605x585
13325103436	PTE/MR-4x36W. H.F.	242,80 €	(8,3)	1185x585
13325103336	PTE/MR-3x36W. H.F.	223,58 €	(8,3)	1185x585
13325103236	PTE/MR-2x36W. H.F.	130,71 €	(5,5)	1180x285
13325103318	PTE/MR-3x18W. H.F.	127,18 €	(4,5)	605x585
13325103218	PTE/MR-2x18W. H.F.	90,35 €	(2,6)	285x285
13325103418	PTE/MR-4x18W. H.F.	134,42 €	(4,6)	605x585

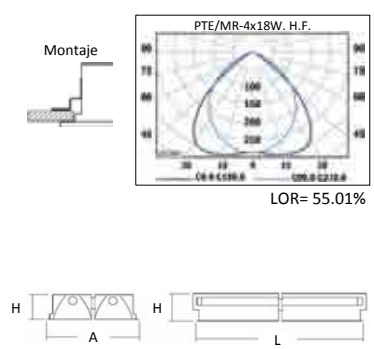

336/436W. - A= 622, L=1220, H=92
 236W. - A= 320, L=1220, H=92
 318W. - A= 622, L= 622, H=92
 418W. - A= 622, L= 622, H=92
 218W. - A= 320, L= 620, H=82

EMPOTRABLES T-8

Materiales: Cuerpo en chapa de acero, difusor plancha prisma. Techos armstrong.

CODIGO	REFERENCIA	P.V.P.	Kg.
13326002436	P/PRISMA-4x36W. 230V. A.F.	143,05 €	(10,0)
13326002336	P/PRISMA-3x36W. 230V. A.F.	137,68 €	(10,0)
13326002236	P/PRISMA-2x36W. 230V. A.F.	83,93 €	(5,4)
13326002318	P/PRISMA-3x18W. 230V. A.F.	80,81 €	(5,5)
13326002218	P/PRISMA-2x18W. 230V. A.F.	51,83 €	(3,2)
13326002418	P/PRISMA-4x18W. 230V. A.F.	80,21 €	(5,2)
13326003436	P/PRISMA-4x36W. H.F.	181,75 €	(8,3)
13326003336	P/PRISMA-3x36W. H.F.	176,39 €	(8,3)
13326003236	P/PRISMA-2x36W. H.F.	102,55 €	(4,8)
13326003318	P/PRISMA-3x18W. H.F.	102,96 €	(4,3)
13326003218	P/PRISMA-2x18W. H.F.	79,16 €	(2,6)
13326003418	P/PRISMA-4x18W. H.F.	103,79 €	(4,6)



336/436W. - A= 595, L=1195, H=92
 236W. - A= 295, L=1195, H=82
 318W. - A= 595, L= 595, H=92
 418W. - A= 595, L= 595, H=72
 218W. - A= 295, L= 595, H=82

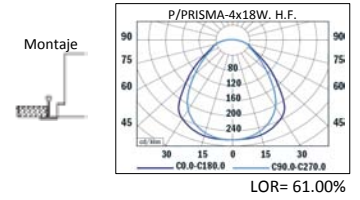

Materiales: Cuerpo en chapa de acero, difusor plancha prisma. Techos escayola lisa.

CODIGO	REFERENCIA	P.V.P.	Kg.
13328702436	PTE/PRISMA-4x36W. 230V. A.F.	150,93 €	(10,3)
13328702336	PTE/PRISMA-3x36W. 230V. A.F.	137,90 €	(10,3)
13328702236	PTE/PRISMA-2x36W. 230V. A.F.	89,52 €	(6,4)
13328702318	PTE/PRISMA-3x18W. 230V. A.F.	87,23 €	(6,0)
13328702218	PTE/PRISMA-2x18W. 230V. A.F.	59,30 €	(3,4)
13328702418	PTE/PRISMA-4x18W. 230V. A.F.	84,34 €	(5,4)
13328703436	PTE/PRISMA-4x36W. H.F.	187,76 €	(8,6)
13328703336	PTE/PRISMA-3x36W. H.F.	221,93 €	(8,6)
13328703236	PTE/PRISMA-2x36W. H.F.	107,92 €	(5,8)
13328703318	PTE/PRISMA-3x18W. H.F.	108,97 €	(4,7)
13328703218	PTE/PRISMA-2x18W. H.F.	86,63 €	(2,8)
13328703418	PTE/PRISMA-4x18W. H.F.	109,79 €	(4,8)



Anclajes incluidos

336/436W. - A= 622, L=1220, H=92
 236W. - A= 320, L=1220, H=92
 318W. - A= 622, L= 622, H=92
 418W. - A= 622, L= 622, H=92
 218W. - A= 320, L= 620, H=82

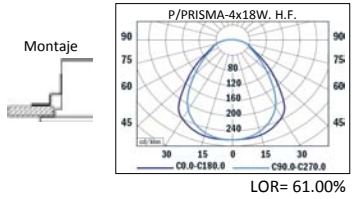

Materiales: Cuerpo en chapa de acero, difusor plancha opal. Techos armstrong.

CODIGO	REFERENCIA	P.V.P.	Kg.
13326102436	P/OPAL-4x36W. 230V. A.F.	172,86 €	(10,0)
13326102336	P/OPAL-3x36W. 230V. A.F.	163,13 €	(10,0)
13326102236	P/OPAL-2x36W. 230V. A.F.	95,11 €	(5,4)
13326102318	P/OPAL-3x18W. 230V. A.F.	96,95 €	(5,5)
13326102218	P/OPAL-2x18W. 230V. A.F.	57,88 €	(3,2)
13326102418	P/OPAL-4x18W. 230V. A.F.	95,11 €	(5,2)
13326103436	P/OPAL-4x36W. H.F.	211,56 €	(8,4)
13326103336	P/OPAL-3x36W. H.F.	206,80 €	(8,4)
13326103236	P/OPAL-2x36W. H.F.	113,92 €	(4,8)
13326103318	P/OPAL-3x18W. H.F.	117,87 €	(4,3)
13326103218	P/OPAL-2x18W. H.F.	83,72 €	(2,6)
13326103418	P/OPAL-4x18W. H.F.	118,69 €	(4,6)



336/436W. - A= 595, L=1195, H=92
 236W. - A= 295, L=1195, H=82
 318W. - A= 595, L= 595, H=92
 418W. - A= 595, L= 595, H=92
 218W. - A= 295, L= 595, H=82

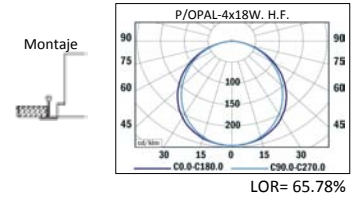

Materiales: Cuerpo en chapa de acero, difusor plancha opal. Techos escayola lisa.

CODIGO	REFERENCIA	P.V.P.	Kg.
13327702436	PTE/OPAL-4x36W. 230V. A.F.	178,86 €	(10,3)
13327702336	PTE/OPAL-3x36W. 230V. A.F.	169,14 €	(10,3)
13327702236	PTE/OPAL-2x36W. 230V. A.F.	100,67 €	(6,4)
13327702318	PTE/OPAL-3x18W. 230V. A.F.	101,91 €	(6,0)
13327702218	PTE/OPAL-2x18W. 230V. A.F.	64,89 €	(3,4)
13327702418	PTE/OPAL-4x18W. 230V. A.F.	101,31 €	(5,4)
13327703436	PTE/OPAL-4x36W. H.F.	217,57 €	(8,6)
13327703336	PTE/OPAL-3x36W. H.F.	212,62 €	(8,6)
13327703236	PTE/OPAL-2x36W. H.F.	119,10 €	(5,8)
13327703318	PTE/OPAL-3x18W. H.F.	123,87 €	(4,7)
13327703218	PTE/OPAL-2x18W. H.F.	87,87 €	(2,8)
13327703418	PTE/OPAL-4x18W. H.F.	124,70 €	(4,8)



Anclajes incluidos

336/436W. - A= 622, L=1220, H=92
 236W. - A= 320, L=1220, H=92
 318W. - A= 622, L= 622, H=92
 418W. - A= 622, L= 622, H=92
 218W. - A= 320, L= 620, H=82

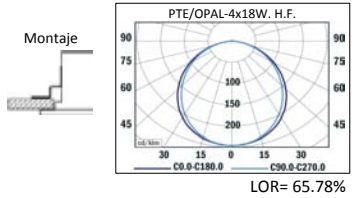

EMPOTRABLES ULTIMA GENERACION T5-FC

Materiales: Cuerpo en chapa de acero, anillo reflector de aluminio brillante, difusor PMMA opal. Techos armstrong.

CODIGO	REFERENCIA	P.V.P.	Kg.
13326613040	PYRAMIDE/E-OPAL-IN - 40W. H.F.	215,19 €	(4,9)
13326613055	PYRAMIDE/E-OPAL-IN - 55W. H.F.	282,12 €	(4,9)
13326613060	PYRAMIDE/E-OPAL-IN - 60W. H.F.	248,46 €	(4,9)
13326613422	PYRAMIDE/E-OPAL-IN - 40+22W. H.F.	265,74 €	(5,0)
13326613522	PYRAMIDE/E-OPAL-IN - 55+22W. H.F.	332,67 €	(5,0)
13326613622	PYRAMIDE/E-OPAL-IN - 60+22W. H.F.	299,01 €	(5,0)
13326613640	PYRAMIDE/E-OPAL-IN - 60+40W. H.F.	299,01 €	(5,0)

Techos de escayola lisa referencia "PYRAMIDE/E-PTE-OPAL-IN" bajo consulta.

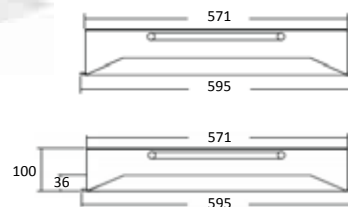

Materiales: Cuerpo en chapa de acero, anillo reflector de aluminio brillante, difusor PMMA opal. Techos armstrong.

CODIGO	REFERENCIA	P.V.P.	Kg.
13326603040	PYRAMIDE/E-OPAL-OUT - 40W. H.F.	215,19 €	(4,9)
13326603055	PYRAMIDE/E-OPAL-OUT - 55W. H.F.	282,12 €	(4,9)
13326603060	PYRAMIDE/E-OPAL-OUT - 60W. H.F.	248,46 €	(4,9)
13326603422	PYRAMIDE/E-OPAL-OUT - 40+22W. H.F.	265,74 €	(5,0)
13326603522	PYRAMIDE/E-OPAL-OUT - 55+22W. H.F.	332,67 €	(5,0)
13326603622	PYRAMIDE/E-OPAL-OUT - 60+22W. H.F.	299,01 €	(5,0)
13326603640	PYRAMIDE/E-OPAL-OUT - 60+40W. H.F.	299,01 €	(5,0)

Techos de escayola lisa referencia "PYRAMIDE/E-PTE-OPAL-OUT" bajo consulta.

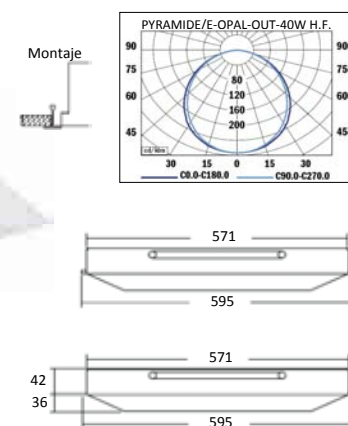

Materiales: Cuerpo en chapa de acero, anillo reflector de aluminio brillante, difusor PMMA prismático. Techos armstrong.

CODIGO	REFERENCIA	P.V.P.	Kg.
13326713040	PYRAMIDE/E-PRISMA-IN - 40W. H.F.	215,19 €	(4,9)
13326713055	PYRAMIDE/E-PRISMA-IN - 55W. H.F.	282,12 €	(4,9)
13326713060	PYRAMIDE/E-PRISMA-IN - 60W. H.F.	248,46 €	(4,9)
13326713422	PYRAMIDE/E-PRISMA-IN - 40+22W. H.F.	265,74 €	(5,0)
13326713522	PYRAMIDE/E-PRISMA-IN - 55+22W. H.F.	332,67 €	(5,0)
13326713622	PYRAMIDE/E-PRISMA-IN - 60+22W. H.F.	299,01 €	(5,0)
13326713640	PYRAMIDE/E-PRISMA-IN - 60+40W. H.F.	299,01 €	(5,0)

Techos de escayola lisa referencia "PYRAMIDE/E-PTE-PRISMA-IN" bajo consulta.

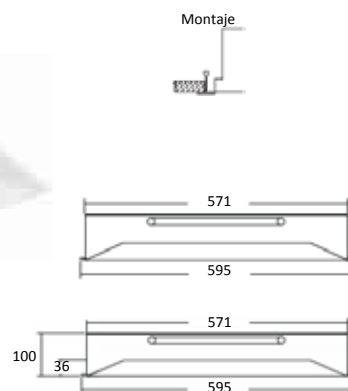

Materiales: Cuerpo en chapa de acero, anillo reflector de aluminio brillante, difusor PMMA prismático. Techos armstrong.

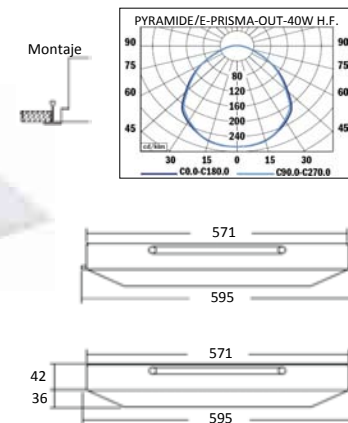
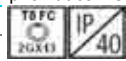

CODIGO	REFERENCIA	P.V.P.	Kg.
13326703040	PYRAMIDE/E-PRISMA-OUT - 40W. H.F.	215,19 €	(4,9)
13326703055	PYRAMIDE/E-PRISMA-OUT - 55W. H.F.	282,12 €	(4,9)
13326703060	PYRAMIDE/E-PRISMA-OUT - 60W. H.F.	248,46 €	(4,9)
13326703422	PYRAMIDE/E-PRISMA-OUT - 40+22W. H.F.	265,74 €	(5,0)
13326703522	PYRAMIDE/E-PRISMA-OUT - 55+22W. H.F.	332,67 €	(5,0)
13326703622	PYRAMIDE/E-PRISMA-OUT - 60+22W. H.F.	299,01 €	(5,0)
13326703640	PYRAMIDE/E-PRISMA-OUT - 60+40W. H.F.	299,01 €	(5,0)

Techos de escayola lisa referencia "PYRAMIDE/E-PTE-PRISMA-OUT" bajo consulta.





EMPOTRABLES IP54 SALAS BLANCAS ESCAYOLA LISA MODULARES

Materiales: Cuerpo en chapa de acero esmaltada en color blanco, difusor doble parabólico de aluminio brillante. Techos escayola lisa.

CODIGO	REFERENCIA	P.V.P.	Kg.		
15423213318	PTE/BRPC-IP54-3x18W H.F.	335,38 €	(8,3)	607x607	 
15423213418	PTE/BRPC-IP54-4x18W H.F.	345,66 €	(8,3)	607x607	
15423213236	PTE/BRPC-IP54-2x36W H.F.	345,84 €	(7,9)	1211x307	
15423213436	PTE/BRPC-IP54-4x36W H.F.	485,56 €	(14,9)	1211x607	
15423213314	PTE/BRPC-IP54-3x14W H.F.	335,38 €	(8,3)	607x607	
15423213414	PTE/BRPC-IP54-4x14W H.F.	345,66 €	(8,3)	607x607	
15423213324	PTE/BRPC-IP54-3x24W H.F.	341,82 €	(8,3)	607x607	
15423213424	PTE/BRPC-IP54-4x24W H.F.	354,42 €	(8,3)	607x607	
15423213228	PTE/BRPC-IP54-2x28W H.F.	345,84 €	(7,9)	1211x307	
15423213254	PTE/BRPC-IP54-2x54W H.F.	345,84 €	(7,9)	1211x307	
15423213428	PTE/BRPC-IP54-4x28W H.F.	485,56 €	(14,9)	1211x607	
15423213454	PTE/BRPC-IP54-4x54W H.F.	485,56 €	(14,9)	1211x607	
15423213340	PTE/BRPC-IP54-3x40W TC-L H.F.	364,35 €	(8,6)	607x607	
15423213355	PTE/BRPC-IP54-3x55W TC-L H.F.	364,35 €	(8,6)	607x607	



Techos modulares 600x600: Mismo precio, referencia P/BRPC-IP54.

Materiales: Cuerpo en chapa de acero esmaltada en color blanco, difusor doble parabólico de aluminio satinado mate. Techos escayola lisa.

CODIGO	REFERENCIA	P.V.P.	Kg.		
15423223318	PTE/MRPC-IP54-3x18W H.F.	341,87 €	(8,3)	607x607	 
15423223418	PTE/MRPC-IP54-4x18W H.F.	352,10 €	(8,3)	607x607	
15423223236	PTE/MRPC-IP54-2x36W H.F.	349,37 €	(7,9)	1211x307	
15423223436	PTE/MRPC-IP54-4x36W H.F.	493,25 €	(14,9)	1211x607	
15423223314	PTE/MRPC-IP54-3x14W H.F.	341,87 €	(8,3)	607x607	
15423223414	PTE/MRPC-IP54-4x14W H.F.	352,10 €	(8,3)	607x607	
15423223324	PTE/MRPC-IP54-3x24W H.F.	348,48 €	(8,3)	607x607	
15423223424	PTE/MRPC-IP54-4x24W H.F.	357,55 €	(8,3)	607x607	
15423223228	PTE/MRPC-IP54-2x28W H.F.	349,37 €	(7,9)	1211x307	
15423223254	PTE/MRPC-IP54-2x54W H.F.	349,37 €	(7,9)	1211x307	
15423223428	PTE/MRPC-IP54-4x28W H.F.	493,47 €	(14,9)	1211x607	
15423223454	PTE/MRPC-IP54-4x54W H.F.	493,37 €	(14,9)	1211x607	
15423223340	PTE/MRPC-IP54-3x40W TC-L H.F.	370,96 €	(8,6)	607x607	
15423223355	PTE/MRPC-IP54-3x55W TC-L H.F.	370,96 €	(8,6)	607x607	



Techos modulares 600x600: Mismo precio, referencia P/MRPC-IP54.

Materiales: Cuerpo en chapa de acero esmaltada en color blanco, difusor plancha opal policarbonato. Techos escayola lisa.

CODIGO	REFERENCIA	P.V.P.	Kg.		
15423233318	PTE/OPALPC-IP54-3x18W H.F.	305,04 €	(7,7)	607x607	 
15423233418	PTE/OPALPC-IP54-4x18W H.F.	309,95 €	(7,7)	607x607	
15423233236	PTE/OPALPC-IP54-2x36W H.F.	310,98 €	(7,3)	1211x307	
15423233436	PTE/OPALPC-IP54-4x36W H.F.	419,86 €	(14,3)	1211x607	
15423233314	PTE/OPALPC-IP54-3x14W H.F.	305,04 €	(7,7)	607x607	
15423233414	PTE/OPALPC-IP54-4x14W H.F.	309,95 €	(7,7)	607x607	
15423233324	PTE/OPALPC-IP54-3x24W H.F.	310,58 €	(7,7)	607x607	
15423233424	PTE/OPALPC-IP54-4x24W H.F.	316,43 €	(7,7)	607x607	
15423233228	PTE/OPALPC-IP54-2x28W H.F.	310,98 €	(7,3)	1211x307	
15423233254	PTE/OPALPC-IP54-2x54W H.F.	310,98 €	(7,3)	1211x307	
15423233428	PTE/OPALPC-IP54-4x28W H.F.	419,86 €	(14,3)	1211x607	
15423233454	PTE/OPALPC-IP54-4x54W H.F.	419,86 €	(14,3)	1211x607	
15423233340	PTE/OPALPC-IP54-3x40W TC-L H.F.	333,15 €	(8,0)	607x607	
15423233355	PTE/OPALPC-IP54-3x55W TC-L H.F.	333,15 €	(8,0)	607x607	

Techos modulares 600x600: Mismo precio, referencia P/OPALPC-IP54.

Materiales: Cuerpo en chapa de acero esmaltada en color blanco, difusor plancha prisma policarbonato. Techos escayola lisa.

CODIGO	REFERENCIA	P.V.P.	Kg.		
15423243318	PTE/PRISMAPC-IP54-3x18W H.F.	273,97 €	(7,4)	607x607	 
15423243418	PTE/PRISMAPC-IP54-4x18W H.F.	279,56 €	(7,4)	607x607	
15423243236	PTE/PRISMAPC-IP54-2x36W H.F.	280,72 €	(7,0)	1211x307	
15423243436	PTE/PRISMAPC-IP54-4x36W H.F.	357,11 €	(14,0)	1211x607	
15423243314	PTE/PRISMAPC-IP54-3x14W H.F.	273,97 €	(7,4)	607x607	
15423243414	PTE/PRISMAPC-IP54-4x14W H.F.	279,56 €	(7,4)	607x607	
15423243324	PTE/PRISMAPC-IP54-3x24W H.F.	280,59 €	(7,4)	607x607	
15423243424	PTE/PRISMAPC-IP54-4x24W H.F.	289,75 €	(7,4)	607x607	
15423243228	PTE/PRISMAPC-IP54-2x28W H.F.	280,72 €	(7,0)	1211x307	
15423243254	PTE/PRISMAPC-IP54-2x54W H.F.	280,72 €	(7,0)	1211x307	
15423243428	PTE/PRISMAPC-IP54-4x28W H.F.	357,11 €	(14,0)	1211x607	
15423243454	PTE/PRISMAPC-IP54-4x54W H.F.	357,11 €	(14,0)	1211x607	
15423243340	PTE/PRISMAPC-IP54-3x40W TC-L H.F.	303,16 €	(7,7)	607x607	
15423243355	PTE/PRISMAPC-IP54-3x55W TC-L H.F.	303,16 €	(7,7)	607x607	

Techos modulares 600x600: Mismo precio, referencia P/PRISMAPC-IP54.

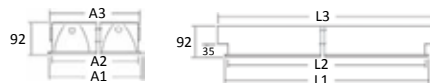

318/418W.	- A1=622 A2=576 A3=604 L1= 622 L2= 576 L3= 629
236W.	- A1=322 A2=276 A3=304 L1=1222 L2=1176 L3=1239
436W.	- A1=622 A2=576 A3=604 L1=1222 L2=1176 L3=1239
314/414/324/424W.	- A1=622 A2=576 A3=604 L1= 622 L2= 576 L3= 629
228/254W.	- A1=322 A2=276 A3=304 L1=1222 L2=1176 L3=1239
428/454W.	- A1=622 A2=576 A3=604 L1=1222 L2=1176 L3=1239
340/355W. TC-L	- A1=622 A2=576 A3=604 L1= 622 L2= 576 L3= 629

EMPOTRABLES IP65 SALAS BLANCAS ESCAYOLA LISA MODULARES

Materiales: Cuerpo en chapa de acero esmaltada en color blanco, difusor doble parabólico de aluminio brillante. Techos escayola lisa.

CODIGO	REFERENCIA	P.V.P.	Kg.		
15423413318	PTE/BRPC-IP65-3x18W H.F.	379,47 €	(8,3)	607x607	
15423413418	PTE/BRPC-IP65-4x18W H.F.	389,75 €	(8,3)	607x607	
15423413236	PTE/BRPC-IP65-2x36W H.F.	423,10 €	(7,9)	1211x307	
15423413436	PTE/BRPC-IP65-4x36W H.F.	557,04 €	(14,9)	1211x607	
15423413314	PTE/BRPC-IP65-3x14W H.F.	379,47 €	(8,3)	607x607	
15423413414	PTE/BRPC-IP65-4x14W H.F.	389,75 €	(8,3)	607x607	
15423413324	PTE/BRPC-IP65-3x24W H.F.	385,06 €	(8,3)	607x607	
15423413424	PTE/BRPC-IP65-4x24W H.F.	397,66 €	(8,3)	607x607	
15423413228	PTE/BRPC-IP65-2x28W H.F.	423,10 €	(7,9)	1211x307	
15423413254	PTE/BRPC-IP65-2x54W H.F.	423,10 €	(7,9)	1211x307	
15423413428	PTE/BRPC-IP65-4x28W H.F.	557,04 €	(14,9)	1211x607	
15423413454	PTE/BRPC-IP65-4x54W H.F.	557,04 €	(14,9)	1211x607	
15423413340	PTE/BRPC-IP65-3x40W TC-L H.F.	408,33 €	(8,6)	607x607	
15423413355	PTE/BRPC-IP65-3x55W TC-L H.F.	408,33 €	(8,6)	607x607	

Techos modulares 600x600: Mismo precio, referencia P/BRPC-IP65.

Materiales: Cuerpo en chapa de acero esmaltada en color blanco, difusor doble parabólico de aluminio satinado mate. Techos escayola lisa.

CODIGO	REFERENCIA	P.V.P.	Kg.		
15423423318	PTE/MRPC-IP65-3x18W H.F.	382,16 €	(8,3)	607x607	
15423423418	PTE/MRPC-IP65-4x18W H.F.	392,86 €	(8,3)	607x607	
15423423236	PTE/MRPC-IP65-2x36W H.F.	426,17 €	(7,9)	1211x307	
15423423436	PTE/MRPC-IP65-4x36W H.F.	563,63 €	(14,9)	1211x607	
15423423314	PTE/MRPC-IP65-3x14W H.F.	382,16 €	(8,3)	607x607	
15423423414	PTE/MRPC-IP65-4x14W H.F.	392,86 €	(8,3)	607x607	
15423423324	PTE/MRPC-IP65-3x24W H.F.	387,71 €	(8,3)	607x607	
15423423424	PTE/MRPC-IP65-4x24W H.F.	399,27 €	(8,3)	607x607	
15423423228	PTE/MRPC-IP65-2x28W H.F.	426,17 €	(7,9)	1211x307	
15423423254	PTE/MRPC-IP65-2x54W H.F.	426,17 €	(7,9)	1211x307	
15423423428	PTE/MRPC-IP65-4x28W H.F.	563,63 €	(14,9)	1211x607	
15423423454	PTE/MRPC-IP65-4x54W H.F.	563,63 €	(14,9)	1211x607	
15423423340	PTE/MRPC-IP65-3x40W TC-L H.F.	411,01 €	(8,6)	607x607	
15423423355	PTE/MRPC-IP65-3x55W TC-L H.F.	411,01 €	(8,6)	607x607	

Techos modulares 600x600: Mismo precio, referencia P/MRPC-IP65.

Materiales: Cuerpo en chapa de acero esmaltada en color blanco, difusor plancha opal policarbonato. Techos escayola lisa.

CODIGO	REFERENCIA	P.V.P.	Kg.		
15423433318	PTE/OPALPC-IP65-3x18W H.F.	348,63 €	(7,7)	607x607	
15423433418	PTE/OPALPC-IP65-4x18W H.F.	354,57 €	(7,7)	607x607	
15423433236	PTE/OPALPC-IP65-2x36W H.F.	389,57 €	(7,3)	1211x307	
15423433436	PTE/OPALPC-IP65-4x36W H.F.	497,04 €	(14,3)	1211x607	
15423433314	PTE/OPALPC-IP65-3x14W H.F.	348,63 €	(7,7)	607x607	
15423433414	PTE/OPALPC-IP65-4x14W H.F.	354,57 €	(7,7)	607x607	
15423433324	PTE/OPALPC-IP65-3x24W H.F.	354,18 €	(7,7)	607x607	
15423433424	PTE/OPALPC-IP65-4x24W H.F.	361,02 €	(7,7)	607x607	
15423433228	PTE/OPALPC-IP65-2x28W H.F.	389,57 €	(7,3)	1211x307	
15423433254	PTE/OPALPC-IP65-2x54W H.F.	389,57 €	(7,3)	1211x307	
15423433428	PTE/OPALPC-IP65-4x28W H.F.	497,04 €	(14,3)	1211x607	
15423433454	PTE/OPALPC-IP65-4x54W H.F.	497,04 €	(14,3)	1211x607	
15423433340	PTE/OPALPC-IP65-3x40W TC-L H.F.	377,44 €	(8,0)	607x607	
15423433355	PTE/OPALPC-IP65-3x55W TC-L H.F.	377,44 €	(8,0)	607x607	

Techos modulares 600x600: Mismo precio, referencia P/OPALPC-IP65.

Materiales: Cuerpo en chapa de acero esmaltada en color blanco, difusor plancha prisma policarbonato. Techos escayola lisa.

CODIGO	REFERENCIA	P.V.P.	Kg.		
15423443318	PTE/PRISMAPC-IP65-3x18W H.F.	319,56 €	(7,4)	607x607	
15423443418	PTE/PRISMAPC-IP65-4x18W H.F.	325,50 €	(7,4)	607x607	
15423443236	PTE/PRISMAPC-IP65-2x36W H.F.	361,28 €	(7,0)	1211x307	
15423443436	PTE/PRISMAPC-IP65-4x36W H.F.	434,79 €	(14,0)	1211x607	
15423443314	PTE/PRISMAPC-IP65-3x14W H.F.	319,56 €	(7,4)	607x607	
15423443414	PTE/PRISMAPC-IP65-4x14W H.F.	325,50 €	(7,4)	607x607	
15423443324	PTE/PRISMAPC-IP65-3x24W H.F.	325,06 €	(7,4)	607x607	
15423443424	PTE/PRISMAPC-IP65-4x24W H.F.	331,95 €	(7,4)	607x607	
15423443228	PTE/PRISMAPC-IP65-2x28W H.F.	361,28 €	(7,0)	1211x307	
15423443254	PTE/PRISMAPC-IP65-2x54W H.F.	361,28 €	(7,0)	1211x307	
15423443428	PTE/PRISMAPC-IP65-4x28W H.F.	434,79 €	(14,0)	1211x607	
15423443454	PTE/PRISMAPC-IP65-4x54W H.F.	434,79 €	(14,0)	1211x607	
15423443340	PTE/PRISMAPC-IP65-3x40W TC-L H.F.	348,37 €	(7,7)	607x607	
15423443355	PTE/PRISMAPC-IP65-3x55W TC-L H.F.	348,37 €	(7,7)	607x607	

Techos modulares 600x600: Mismo precio, referencia P/PRISMAPC-IP65.

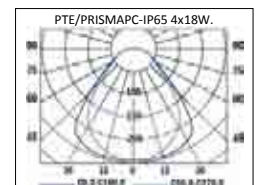
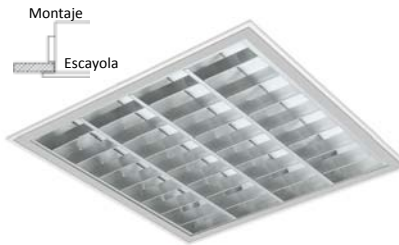
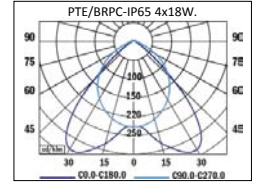
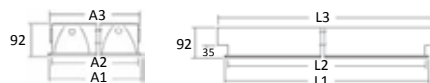

318/418W. - A1=622 A2=576 A3=604 L1= 622 L2= 576 L3= 629
236W. - A1=322 A2=276 A3=304 L1=1222 L2=1176 L3=1239
436W. - A1=622 A2=576 A3=604 L1=1222 L2=1176 L3=1239
314/414/324/424W. - A1=622 A2=576 A3=604 L1= 622 L2= 576 L3= 629
228/254W. - A1=322 A2=276 A3=304 L1=1222 L2=1176 L3=1239
428/454W. - A1=622 A2=576 A3=604 L1=1222 L2=1176 L3=1239
340/355W. TC-L - A1=622 A2=576 A3=604 L1= 622 L2= 576 L3= 629

EMPOTRABLES IP54 SALAS BLANCAS

Materiales: Cuerpo en chapa de acero, difusor doble parabólico billante con cierre transparente. Techos modulares 600x600.

CODIGO	REFERENCIA	P.V.P.	Kg.
154220418	LSBR/E-IP54-4x18W. 230V. A.F.	162,77 €	(6,2)
1542203418	LSBR/E-IP54-4x18W. H.F.	183,12 €	(5,5)
1542204414	LSBR/E-IP54-T5-4x14W. H.F.	193,79 €	(5,5)
1542204424	LSBR/E-IP54-T5-4x24W. H.F.	224,52 €	(5,5)

Accesorios:

1542200418	MARCO LSBR/E (Techos escayola lisa)	42,64 €	---
------------	-------------------------------------	---------	-----

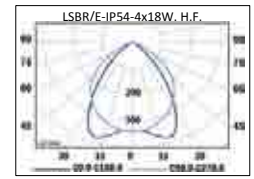

LOR= 62.84%



Materiales: Cuerpo en chapa de acero, difusor plancha opal. Techos modulares 600x600.

CODIGO	REFERENCIA	P.V.P.	Kg.
1542212418	LOPAL/E-IP54-4x18W. 230V. A.F.	157,75 €	(6,3)
1542213418	LOPAL/E-IP54-4x18W. H.F.	183,26 €	(5,6)
1542214414	LOPAL/E-IP54-T5-4x14W. H.F.	178,28 €	(5,6)
1542214424	LOPAL/E-IP54-T5-4x24W. H.F.	212,22 €	(5,6)

Accesorios:

1542200418	MARCO LSBR/E (Techos escayola lisa)	42,64 €	---
------------	-------------------------------------	---------	-----

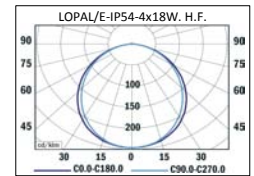
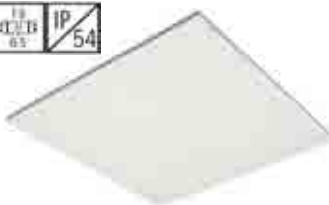

LOR= 65.78%



Materiales: Cuerpo en chapa de acero, difusor plancha prisma. Techos modulares 600x600.

CODIGO	REFERENCIA	P.V.P.	Kg.
1542222418	LPRISMA/E-IP54-4x18W. 230V. A.F.	142,93 €	(6,3)
1542223418	LPRISMA/E-IP54-4x18W. H.F.	168,23 €	(5,6)
1542224414	LPRISMA/E-IP54-T5-4x14W. H.F.	171,67 €	(5,6)
1542224424	LPRISMA/E-IP54-T5-4x24W. H.F.	210,66 €	(5,6)

Accesorios:

1542200418	MARCO LSBR/E (Techos escayola lisa)	42,64 €	---
------------	-------------------------------------	---------	-----

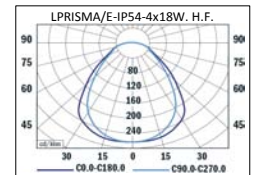
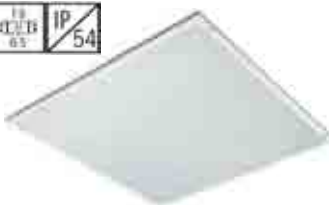

LOR= 61.00%



EMPOTRABLES POLIVALENTES LAMPARAS COMPACTAS

Materiales: Cuerpo en chapa de acero, difusor de aluminio doble parabólico brillante (BR) o mate (MR).

CODIGO	REFERENCIA	P.V.P.	Kg.
13326172236	PCM/BR-2x36W. 230V. A.F.	81,86 €	(4,4)
13326182236	PCM/MR-2x36W. 230V. A.F.	87,96 €	(4,4)
13326173236	PCM/BR-2x36W. H.F.	98,76 €	(2,9)
13326183236	PCM/MR-2x36W. H.F.	107,25 €	(2,9)

Accesorios:

0092301047	ANCLAJES PARA TECHOS DE ESCAYOLA LISA (BAJO PEDIDO, JUEGO 4 UDS.)	5,52 €	---
------------	---	--------	-----

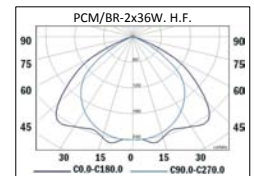

LOR= 63.34%



Materiales: Cuerpo en chapa de acero, difusor de aluminio parabólico brillante con transversales escalonadas.

CODIGO	REFERENCIA	P.V.P.	Kg.
13326162336	PCM/EXT-3x36W. 230V. A.F.	85,62 €	(4,5)
13326163336	PCM/EXT-3x36W. H.F.	106,26 €	(2,9)

Accesorios:

0092301047	ANCLAJES PARA TECHOS DE ESCAYOLA LISA (BAJO PEDIDO, JUEGO 4 UDS.)	5,52 €	---
------------	---	--------	-----

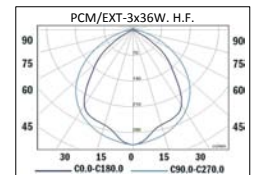

LOR= 61.26%



Materiales: Cuerpo en chapa de acero, difusor de aluminio doble parabólico brillante (BR) o mate (MR).

CODIGO	REFERENCIA	P.V.P.	Kg.
13326172336	PCM/BR-3x36W. 230V. A.F.	91,25 €	(4,6)
13326182336	PCM/MR-3x36W. 230V. A.F.	97,60 €	(4,6)
13326173336	PCM/BR-3x36W. H.F.	111,90 €	(3,0)
13326183336	PCM/MR-3x36W. H.F.	120,75 €	(3,0)

Accesorios:

0092301047	ANCLAJES PARA TECHOS DE ESCAYOLA LISA (BAJO PEDIDO, JUEGO 4 UDS.)	5,52 €	---
------------	---	--------	-----

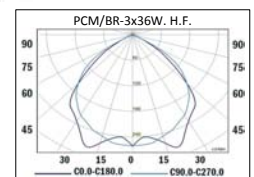
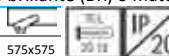

LOR= 57.18%



EMPOTRABLES T-5 ILUMINACION INDIRECTA

Materiales: Cuerpo en chapa de acero, iluminación indirecta (tubos ocultos en los laterales), ranuras decorativas.

CODIGO	REFERENCIA	P.V.P.	Kg.
1362113414	T5-INDIR 4x14W. H.F.	173,60 €	(5,8)
1362113424	T5-INDIR 4x24W. H.F.	194,26 €	(5,8)

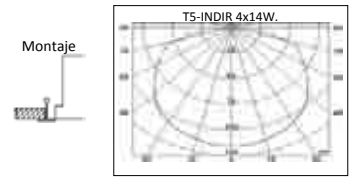

LOR= 42.15%



EMPOTRABLES T-5 ILUMINACION DIRECTA /ASIMETRICA

Materiales: Cuerpo en chapa de acero, iluminación directa mediante reflector doble parabólico brillante y asimétrica mediante reflector asimétrico brillante.

CODIGO	REFERENCIA	P.V.P.	Kg.
15453314	T5-DIR/ASYM 3x14W. H.F.	131,33 €	(5,0)
154253214114	T5-DIR/ASYM 2x14+1x14W.	166,93 €	(5,0)
154253214124	T5-DIR/ASYM 2x14+1x24W.	166,93 €	(5,0)
154253224114	T5-DIR/ASYM 2x24+1x14W.	167,81 €	(5,0)
154253224124	T5-DIR/ASYM 2x24+1x24W.	168,68 €	(5,0)
154253214140	T5-DIR/ASYM 2x14+1x40W.	172,35 €	(5,0)
154253224140	T5-DIR/ASYM 2x24+1x40W.	170,43 €	(5,0)
154253214155	T5-DIR/ASYM 2x14+1x55W.	173,22 €	(5,0)
154253224155	T5-DIR/ASYM 2x24+1x55W.	171,13 €	(5,0)

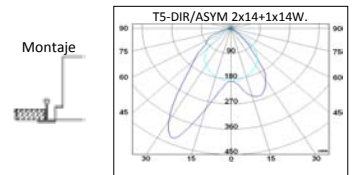
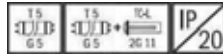

LOR= 54.56%



15453414	T5-DIR/ASYM 4x14W. H.F.	136,02 €	(5,0)
154253314114	T5-DIR/ASYM 3x14+1x14W.	171,04 €	(5,0)
154253314124	T5-DIR/ASYM 3x14+1x24W.	171,91 €	(5,0)
154253324114	T5-DIR/ASYM 3x24+1x14W.	194,63 €	(5,0)
154253324124	T5-DIR/ASYM 3x24+1x24W.	195,50 €	(5,0)
154253314140	T5-DIR/ASYM 3x14+1x40W.	178,38 €	(5,0)
154253324140	T5-DIR/ASYM 3x24+1x40W.	201,97 €	(5,0)
154253314155	T5-DIR/ASYM 3x14+1x55W.	181,52 €	(5,0)
154253324155	T5-DIR/ASYM 3x24+1x55W.	205,11 €	(5,0)

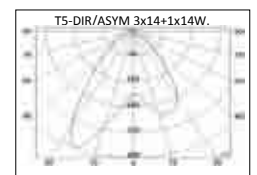

LOR= 52.95%



EMPOTRABLES ILUMINACION INDIRECTA

Materiales: Cuerpo en chapa de acero, difusor microperforado con lámina opal. "Solo techos armstrong".

CODIGO	REFERENCIA	P.V.P.	Kg.	LED	IP 20
13606L440	LD-LED/C-2x19W. 4400lm/840	337,32 €	(4,5)		

Paneles sin perforar bajo consulta.

Estas luminarias son de sencillo montaje y fácil instalación, por su rápida accesibilidad a la borna de conexión.

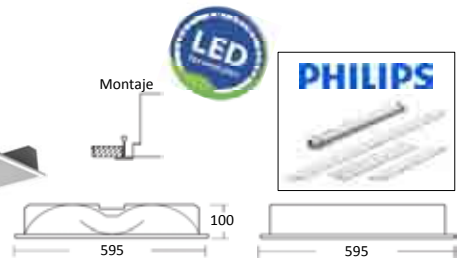

Materiales: Cuerpo en chapa de acero, difusor microperforado con lámina opal. "Solo techos armstrong".

CODIGO	REFERENCIA	P.V.P.	Kg.	LED	IP 20
136063236	LD/C-2x36W. H.F.	134,22 €	(4,5)		
136063255	LD/C-2x55W. H.F.	134,22 €	(4,5)		

Paneles sin perforar bajo consulta.

Estas luminarias son de sencillo montaje y fácil instalación, por su rápida accesibilidad a la borna de conexión.

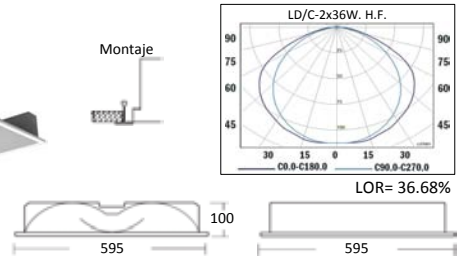

Materiales: Cuerpo en chapa de acero, difusor microperforado con lámina opal. Techos armstrong o escayola lisa.

CODIGO	REFERENCIA	P.V.P.	Kg.	LED	IP 20
136002236	LD-2x36W. 230V. A.F.	134,54 €	(6,5)	575x575	
136003136	LD-1x36W. H.F.	148,88 €	(5,7)	575x575	
136003155	LD-1x55W. H.F.	148,88 €	(5,7)	575x575	
136003236	LD-2x36W. H.F.	157,89 €	(5,7)	575x575	
136003255	LD-2x55W. H.F.	157,89 €	(5,7)	575x575	
0092301047	ANCLAJES PARA TECHOS DE ESCAYOLA LISA	5,52 €	---		

(BAJO PEDIDO, JUEGO 4 UDS.)

Paneles sin perforar bajo consulta.

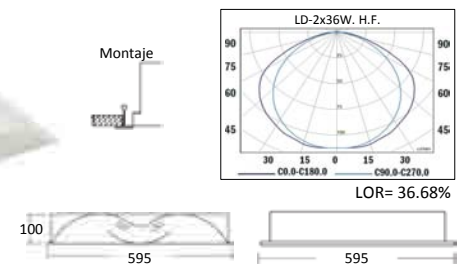

Materiales: Cuerpo en chapa de acero, difusor microperforado con lámina opal. Techos armstrong o escayola lisa.

CODIGO	REFERENCIA	P.V.P.	Kg.	LED	IP 20
136012236	LDL-2x36W. 230V. A.F.	133,20 €	(6,2)	575x575	
136013236	LDL-2x36W. H.F.	157,98 €	(5,4)	575x575	
136013255	LDL-2x55W. H.F.	157,98 €	(5,4)	575x575	
0092301047	ANCLAJES PARA TECHOS DE ESCAYOLA LISA	5,52 €	---		

(BAJO PEDIDO, JUEGO 4 UDS.)

Paneles sin perforar bajo consulta.

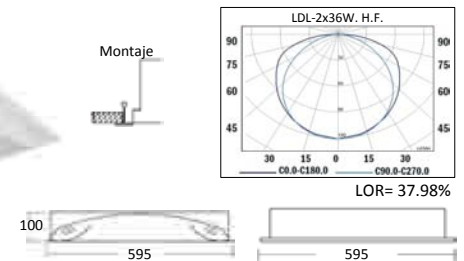

Materiales: Cuerpo en chapa de acero, difusor microperforado con lámina opal. Techos armstrong o escayola lisa.

CODIGO	REFERENCIA	P.V.P.	Kg.	LED	IP 20
136012136	LDA-1x36W. 230V. A.F.	80,00 €	(5,8)	575x575	
136013136	LDA-1x36W. H.F.	90,00 €	(5,0)	575x575	
136013155	LDA-1x55W. H.F.	90,00 €	(5,0)	575x575	
0092301047	ANCLAJES PARA TECHOS DE ESCAYOLA LISA	5,52 €	---		

(BAJO PEDIDO, JUEGO 4 UDS.)

Paneles sin perforar bajo consulta.

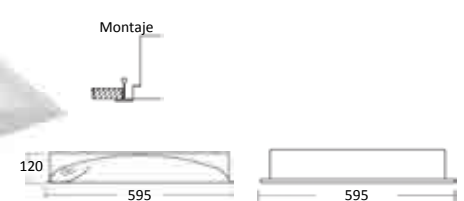

Materiales: Cuerpo en chapa de acero, difusor microperforado con lámina opal. Techos armstrong o escayola lisa.

CODIGO	REFERENCIA	P.V.P.	Kg.	LED	IP 20
13620412236	LDX-2x36W. 230V. A.F.	137,66 €	(6,3)	575x575	
13620413236	LDX-2x36W. H.F.	161,01 €	(5,3)	575x575	
13620413255	LDX-2x55W. H.F.	161,01 €	(5,3)	575x575	
0092301047	ANCLAJES PARA TECHOS DE ESCAYOLA LISA	5,52 €	---		

(BAJO PEDIDO, JUEGO 4 UDS.)

Paneles sin perforar bajo consulta.

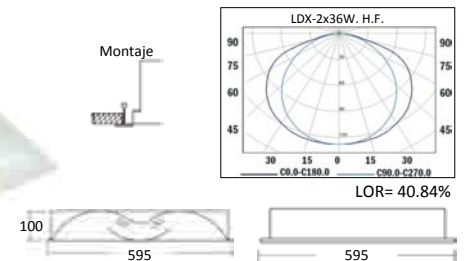

Materiales: Cuerpo en chapa de acero, difusor central doble parabólico con laterales microperforados con lámina opal.

Techos armstrong o escayola lisa.

CODIGO	REFERENCIA	P.V.P.	Kg.	LED	IP 20
1360312236	LD/BR-2x36+1x18W. 230V. A.F.	168,63 €	(6,3)	575x575	
1360313236	LD/BR-2x36+1x18W. H.F.	213,08 €	(5,2)	575x575	
1360313255	LD/BR-2x55+1x18W. H.F.	213,08 €	(5,2)	575x575	
0092301047	ANCLAJES PARA TECHOS DE ESCAYOLA LISA	5,52 €	---		

(BAJO PEDIDO, JUEGO 4 UDS.)

Paneles sin perforar bajo consulta.

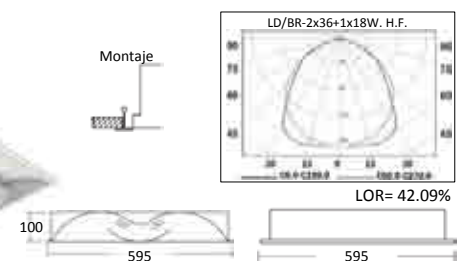

EMPOTRABLES ILUMINACION INDIRECTA

Materiales: Cuerpo en chapa de acero, difusor central doble parabólico con laterales microperforados con lámina opal. "Solo techos armstrong".

CODIGO	REFERENCIA	P.V.P.	Kg.
1362363155	LD/BR-T5/C-1x55W. TC-L H.F.	183,89 €	(4,1)
1362363314	LD/BR-T5/C-3x14W. H.F.	191,95 €	(4,1)
1362363324	LD/BR-T5/C-3x24W. H.F.	219,88 €	(4,1)

Paneles sin perforar bajo consulta.

Estas luminarias son de sencillo montaje y fácil instalación, por su rápida accesibilidad a la borna de conexión.

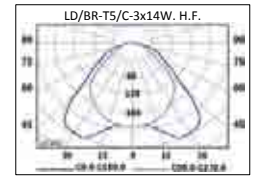

LOR= 53.00%

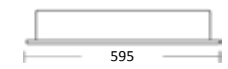

Materiales: Cuerpo en chapa de acero, difusor central doble parabólico con laterales microperforados con lámina opal.

Techos armstrong o escayola lisa.

CODIGO	REFERENCIA	P.V.P.	Kg.
1362313314	LD/BR-T5-3x14W. H.F.	207,61 €	(5,3)
1362313324	LD/BR-T5-3x24W. H.F.	250,93 €	(5,3)
13623132361	LD/BR-T5-2x36+1x14W. H.F.	250,93 €	(5,3)
13623132401	LD/BR-T5-2x40+1x14W. H.F.	250,93 €	(5,3)
13623132551	LD/BR-T5-2x55+1x14W. H.F.	250,93 €	(5,3)
0092301047	ANCLAJES PARA TECHOS DE ESCAYOLA LISA (BAJO PEDIDO, JUEGO 4 UDS.)	5,52 €	---

Paneles sin perforar bajo consulta.

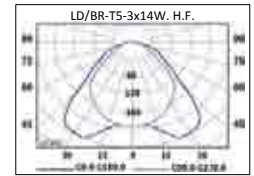

LOR= 53.00%

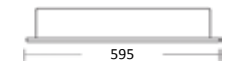

Materiales: Cuerpo en chapa de acero, difusor central doble parabólico con laterales microperforados con lámina opal. "Solo techos armstrong".

CODIGO	REFERENCIA	P.V.P.	Kg.
13623332366	LD/BRD/C-2x36W. H.F.	171,92 €	(4,0)
13623332556	LD/BRD/C-2x55W. H.F.	171,92 €	(4,0)
0092301047	ANCLAJES PARA TECHOS DE ESCAYOLA LISA (BAJO PEDIDO, JUEGO 4 UDS.)	5,52 €	---

Paneles sin perforar bajo consulta.

Estas luminarias son de sencillo montaje y fácil instalación, por su rápida accesibilidad a la borna de conexión.

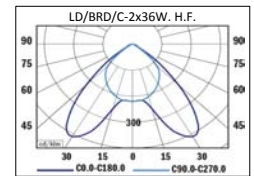

LOR= 63.00%



Materiales: Cuerpo en chapa de acero, difusor microperforado con lámina opal. Techos armstrong o escayola lisa.

CODIGO	REFERENCIA	P.V.P.	Kg.
13623332361	LD/BRD-2x36W. H.F.	185,27 €	(5,2)
13623332551	LD/BRD-2x55W. H.F.	185,27 €	(5,2)
0092301047	ANCLAJES PARA TECHOS DE ESCAYOLA LISA (BAJO PEDIDO, JUEGO 4 UDS.)	5,52 €	---

Paneles sin perforar bajo consulta.

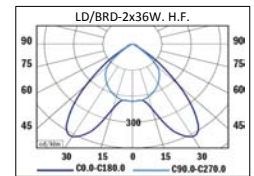

LOR= 63.00%



Materiales: Cuerpo en chapa de acero, difusor central parabólico brillante. Techos armstrong o escayola lisa.

CODIGO	REFERENCIA	P.V.P.	Kg.
136073314	LD-ELITE-3x14W. H.F.	245,88 €	(6,3)
136073324	LD-ELITE-3x24W. H.F.	286,75 €	(6,3)
1360732401	LD-ELITE-2x40+1x14W. H.F.	286,75 €	(6,3)
1360732402	LD-ELITE-2x40+1x24W. H.F.	286,75 €	(6,3)
1360732551	LD-ELITE-2x55+1x14W. H.F.	286,75 €	(6,3)
1360732552	LD-ELITE-2x55+1x24W. H.F.	286,75 €	(6,3)
0092301047	ANCLAJES PARA TECHOS DE ESCAYOLA LISA (BAJO PEDIDO, JUEGO 4 UDS.)	5,52 €	---

Paneles sin perforar bajo consulta.

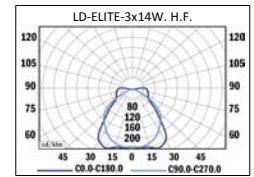

LOR= 54.02%



Materiales: Cuerpo en chapa de acero, difusor central de cristal mate-acido. Techos armstrong o escayola lisa.

CODIGO	REFERENCIA	P.V.P.	Kg.
1362353214	LD/GM-2x14W. H.F.	286,55 €	(8,0)
1362353224	LD/GM-2x24W. H.F.	286,55 €	(8,0)
0092301047	ANCLAJES PARA TECHOS DE ESCAYOLA LISA (BAJO PEDIDO, JUEGO 4 UDS.)	5,52 €	---

Paneles sin perforar bajo consulta.

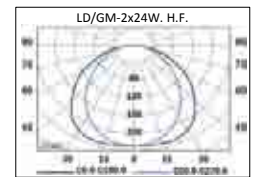

LOR= 71.71%



ADOSABLES ILUMINACION INDIRECTA

Materiales: Cuerpo en chapa de acero, difusor microperforado con lámina opal.

CODIGO	REFERENCIA	P.V.P.	Kg.
1361002236	LD/S-2x36W. 230V. A.F.	154,25 €	(8,5)
1361003255	LD/S-2x55W. H.F.	175,87 €	(7,7)

Paneles sin perforar bajo consulta.

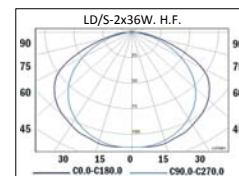

LOR= 36.68%

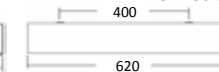

Materiales: Cuerpo en chapa de acero, difusor microperforado con lámina opal.

CODIGO	REFERENCIA	P.V.P.	Kg.
1361002136	LD/S-1x36W. 230V. A.F.	126,83 €	(7,9)
1361003155	LD/S-1x55W. H.F.	159,58 €	(7,5)

Paneles sin perforar bajo consulta.

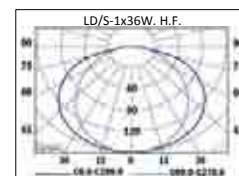

LOR= 36.85%

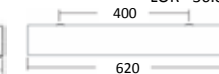
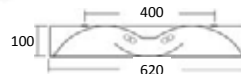

Materiales: Cuerpo en chapa de acero, difusor microperforado con lámina opal.

CODIGO	REFERENCIA	P.V.P.	Kg.
1361012236	LDX/S-2x36W. 230V. A.F.	157,37 €	(9,3)
1361013155	LDX/S-2x55W. H.F.	178,99 €	(8,5)

Paneles sin perforar bajo consulta.

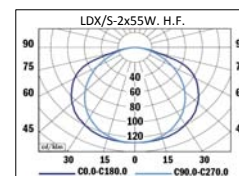

LOR= 40.84%

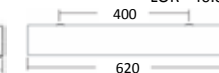
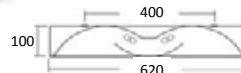

Materiales: Cuerpo en chapa de acero, difusor central doble parabólico con laterales microperforados con lámina opal.

CODIGO	REFERENCIA	P.V.P.	Kg.
1361042236	LD/BR/S-2x36+1x18W. 230V.	183,83 €	(8,9)
1361043255	LD/BR/S-2x55+1x18W. H.F.	228,28 €	(7,8)

Paneles sin perforar bajo consulta.

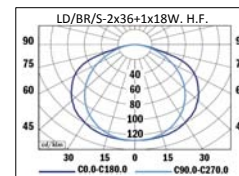
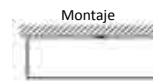

LOR= 42.09%

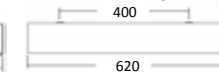
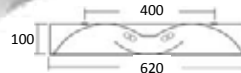

Materiales: Cuerpo en chapa de acero, difusor central doble parabólico con laterales microperforados con lámina opal.

CODIGO	REFERENCIA	P.V.P.	Kg.
1361023314	LD/BR-T5/S-3x14W. H.F.	183,45 €	(7,9)
1361023324	LD/BR-T5/S-3x24W. H.F.	199,17 €	(7,9)
13610232551	LD/BR-T5/S-2x55+1x14W. H.F.	236,86 €	(7,9)
13610232552	LD/BR-T5/S-2x55+1x24W. H.F.	236,86 €	(7,9)

Paneles sin perforar bajo consulta.

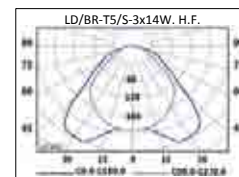

LOR= 53.00%

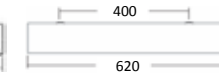
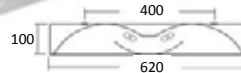

Materiales: Cuerpo en chapa de acero, difusor central doble parabólico con laterales microperforados con lámina opal.

CODIGO	REFERENCIA	P.V.P.	Kg.
1361033214	LD/BRD/S-2x14W. H.F.	198,61 €	(6,6)
1361033224	LD/BRD/S-2x24W. H.F.	198,61 €	(6,6)
1361033255	LD/BRD/S-2x55W. H.F.	198,61 €	(6,6)

Paneles sin perforar bajo consulta.

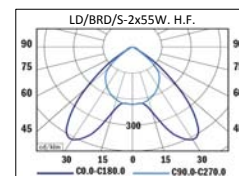

LOR= 63.00%

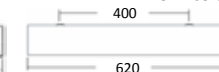
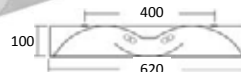

ADOSABLES Y EMPOTRABLES PARA LAMPARAS TC-L Y TC-D

Materiales: Cuerpo en chapa de acero, difusor doble parabólico brillante.

CODIGO	REFERENCIA	P.V.P.	Kg.
15120802218	NPL/BR-2x18W. 230V. A.F.	94,95 €	(2,2)
15120803218	NPL/BR-2x18W. H.F.	133,08 €	(1,9)
15120803224	NPL/BR-2x24W. H.F.	133,08 €	(1,9)
15120802218G	NPL/BR/GRIS-2x18W. 230V. A.F.	111,84 €	(2,2)
15120803218G	NPL/BR/GRIS-2x18W. H.F.	149,98 €	(1,9)
15120803224G	NPL/BR/GRIS-2x24W. H.F.	149,98 €	(1,9)

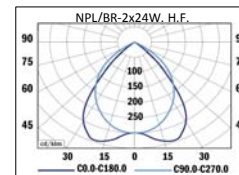
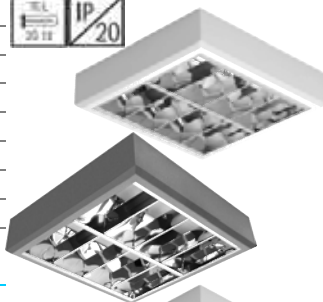

LOR= 57.97%



Materiales: Cuerpo en chapa de acero, difusor doble parabólico mate.

CODIGO	REFERENCIA	P.V.P.	Kg.
15120902218	NPL/MR-2x18W. 230V. A.F.	101,63 €	(2,2)
15120903218	NPL/MR-2x18W. H.F.	136,18 €	(1,9)
15120903224	NPL/MR-2x24W. H.F.	136,18 €	(1,9)
15120902218G	NPL/MR/GRIS-2x18W. 230V. A.F.	118,52 €	(2,2)
15120903218G	NPL/MR/GRIS-2x18W. H.F.	153,08 €	(1,9)
15120903224G	NPL/MR/GRIS-2x24W. H.F.	153,08 €	(1,9)

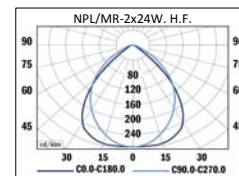
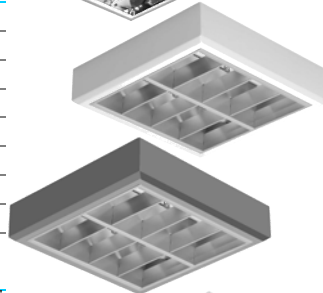

LOR= 50.21%



Materiales: Cuerpo en chapa de acero, difusor doble parabólico brillante.

CODIGO	REFERENCIA	P.V.P.	Kg.
13338002218	EPL/BR-2x18W. 230V. A.F.	59,91 €	(2,2)
13338003218	EPL/BR-2x18W. H.F.	98,54 €	(1,9)
13338003224	EPL/BR-2x24W. H.F.	98,54 €	(1,9)

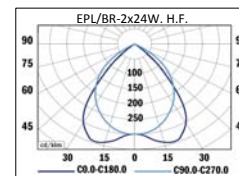
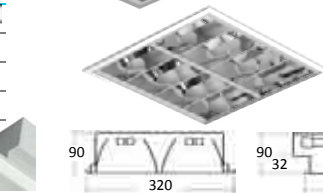

LOR= 57.97%

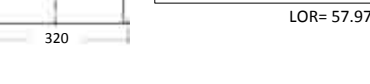

Materiales: Cuerpo en chapa de acero, difusor doble parabólico mate.

CODIGO	REFERENCIA	P.V.P.	Kg.
13339002218	EPL/MR-2x18W. 230V. A.F.	63,01 €	(2,2)
13339003218	EPL/MR-2x18W. H.F.	101,14 €	(1,9)
13339003224	EPL/MR-2x24W. H.F.	101,14 €	(1,9)

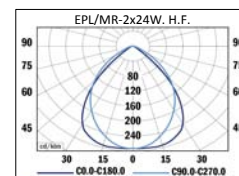
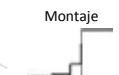
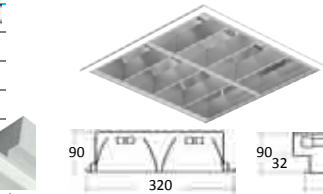

LOR= 50.21%

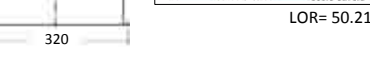

Materiales: Cuerpo en chapa de acero, difusor cristal opal.

CODIGO	REFERENCIA	P.V.P.	Kg.
13337002218	EPL/CRISTAL-2x18W. 230V. A.F.	100,70 €	(2,2)
13337003218	EPL/CRISTAL-2x18W. H.F.	138,88 €	(1,9)
13337003224	EPL/CRISTAL-2x24W. H.F.	138,88 €	(1,9)

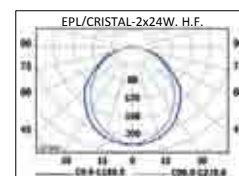
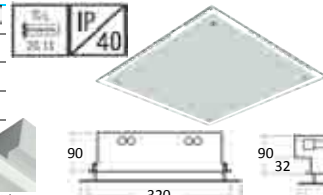

LOR= 52.34%



ACCESORIOS

13330	PLACA METALICA 595x595x10	20,32 €	---
-------	---------------------------	---------	-----



Materiales: Cuerpo en chapa de acero, difusor plástico de color rojo, azul, verde o amarillo.

CODIGO	REFERENCIA	P.V.P.	Kg.
1360322226R	INDI ROJO-2x26W. 230V. A.F.	52,81 €	(5,4)
1360322226AZ	INDI AZUL-2x26W. 230V. A.F.	52,81 €	(5,4)
1360322226V	INDI VERDE-2x26W. 230V. A.F.	52,81 €	(5,4)
1360322226AM	INDI AMARILLO-2x26W. 230V. A.F.	52,81 €	(5,4)
1360323226R	INDI ROJO-2x26W. H.F.	93,08 €	(4,4)
1360323226AZ	INDI AZUL-2x26W. H.F.	93,08 €	(4,4)
1360323226V	INDI VERDE-2x26W. H.F.	93,08 €	(4,4)
1360323226AM	INDI AMARILLO-2x26W. H.F.	93,08 €	(4,4)

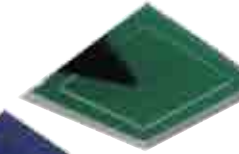



Materiales: Cuerpo en chapa de acero, marco de aluminio extruido, difusor PMMA opal + PMMA microprisma.

CODIGO	REFERENCIA	Indice rendimiento de color CRI (Ra)	Temperatura de color CCT (k)	P.V.P.	Kg.
LAB0L095	LEDBOX/C-14W. 950lm/830	>80	3000	636,86 €	(3,9)
LAB0L096	LEDBOX/C-14W. 950lm/840	>80	4000	636,86 €	(3,9)
LAB1L410	LEDBOX/C-52W. 4100lm/830	>80	3000	1.108,40 €	(11,0)
LAB1L411	LEDBOX/C-52W. 4100lm/840	>80	4000	1.108,40 €	(11,0)

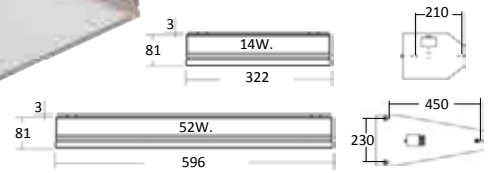
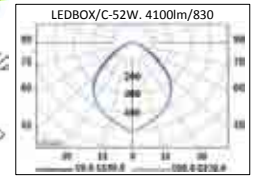
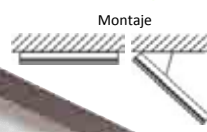

ADOSABLES T-5 BAJA LUMINANCIA

Materiales: Cuerpo en chapa de acero, difusor doble parabólico brillante, chasis compacto.

CODIGO	REFERENCIA	P.V.P.	Kg.
1562105414	NV-4x14W. H.F.	131,35 €	(3,1)
1562105424	NV-4x24W. H.F.	165,58 €	(3,1)

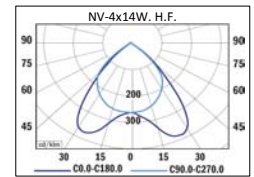
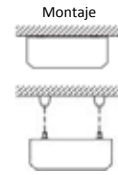

1562105228	NV-2x28W. H.F.	142,34 €	(4,9)
1562105254	NV-2x54W. H.F.	142,34 €	(4,9)
1562105235	NV-2x35W. H.F.	162,28 €	(6,0)
1562105249	NV-2x49W. H.F.	162,28 €	(6,0)
1562105280	NV-2x80W. H.F.	200,66 €	(6,0)

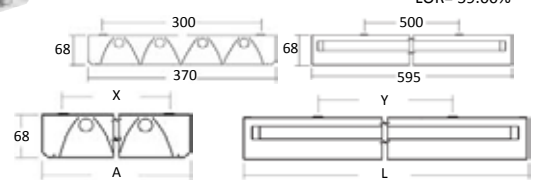
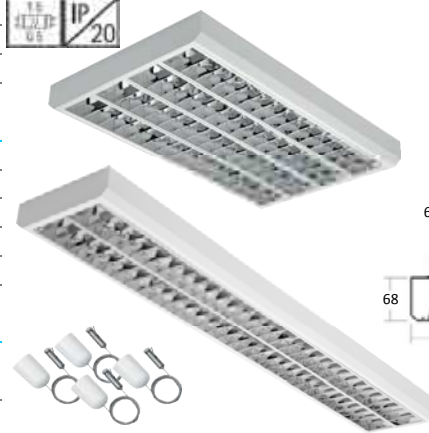

228/254/428W. - L=1218, Y=1125
235/249/280/435W. - L=1518, Y=1425

15620001	SET DE SUSPENSION (BAJO PEDIDO, JUEGO 4 UDS.)	31,18 €	---
----------	---	---------	-----

Materiales: Cuerpo en chapa de acero, difusor doble parabólico brillante, chasis ultracompacto.

CODIGO	REFERENCIA	P.V.P.	Kg.
1562005414	NT-5-4x14W. H.F.	161,06 €	(6,0)
1562005424	NT-5-4x24W. H.F.	201,93 €	(6,0)
156203000001B	INTERRUPTOR TIRADOR PULL SWITCH BLANCO	56,32 €	-
---	SENSOR	BAJO CONSULTA	-

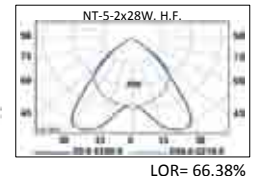

1562005214	NT-5-2x14W. H.F.	135,59 €	(3,5)
1562005224	NT-5-2x24W. H.F.	135,59 €	(3,5)
1562005228	NT-5-2x28W. H.F.	168,97 €	(5,3)
1562005254	NT-5-2x54W. H.F.	168,97 €	(5,3)
1562005235	NT-5-2x35W. H.F.	197,57 €	(6,4)
1562005249	NT-5-2x49W. H.F.	197,57 €	(6,4)
1562005280	NT-5-2x80W. H.F.	239,91 €	(6,4)

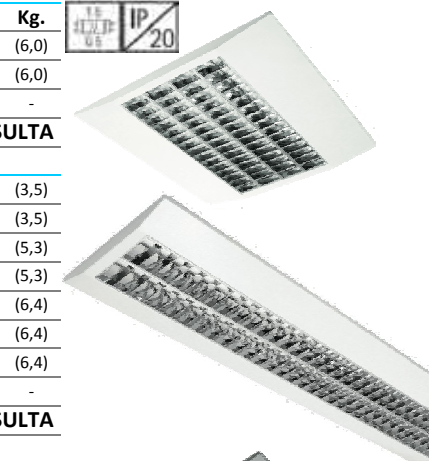

228/254W. - L1=1220, L2=1170, S= 973
235/249/280W. - L1=1520, L2=1470, S=1273

1562005414G	NT-5/GRIS-4x14W. H.F.	179,25 €	(6,0)
1562005424G	NT-5/GRIS-4x24W. H.F.	218,24 €	(6,0)
156203000001B	INTERRUPTOR TIRADOR PULL SWITCH BLANCO	56,32 €	-
---	SENSOR	BAJO CONSULTA	-



1562005214G	NT-5/GRIS-2x14W. H.F.	154,66 €	(3,5)
1562005224G	NT-5/GRIS-2x24W. H.F.	154,66 €	(3,5)
1562005228G	NT-5/GRIS-2x28W. H.F.	187,16 €	(5,3)
1562005254G	NT-5/GRIS-2x54W. H.F.	187,16 €	(5,3)
1562005235G	NT-5/GRIS-2x35W. H.F.	215,76 €	(6,4)
1562005249G	NT-5/GRIS-2x49W. H.F.	215,76 €	(6,4)
1562005280G	NT-5/GRIS-2x80W. H.F.	257,24 €	(6,4)
156203000001B	INTERRUPTOR TIRADOR PULL SWITCH BLANCO	56,32 €	-
---	SENSOR	BAJO CONSULTA	-

15620001	SET DE SUSPENSION (BAJO PEDIDO, JUEGO 4 UDS.)	31,18 €	---
----------	---	---------	-----



ADOSABLES T-5 BAJA LUMINANCIA

Materiales: Cuerpo en chapa de acero, difusor doble parabólico brillante, chasis compacto.

CODIGO	REFERENCIA	P.V.P.	Kg.
1562303414	NX-T5-4x14W. H.F.	179,63 €	(6,2)
1562303424	NX-T5-4x24W. H.F.	198,14 €	(6,2)

1562313414	NX-T5/MICRO-4x14W.	209,82 €	(6,2)
1562313424	NX-T5/MICRO-4x24W.	227,41 €	(6,2)

15620001	SET DE SUSPENSION (BAJO PEDIDO, JUEGO 4 UDS.)	31,18 €	---
----------	---	----------------	-----

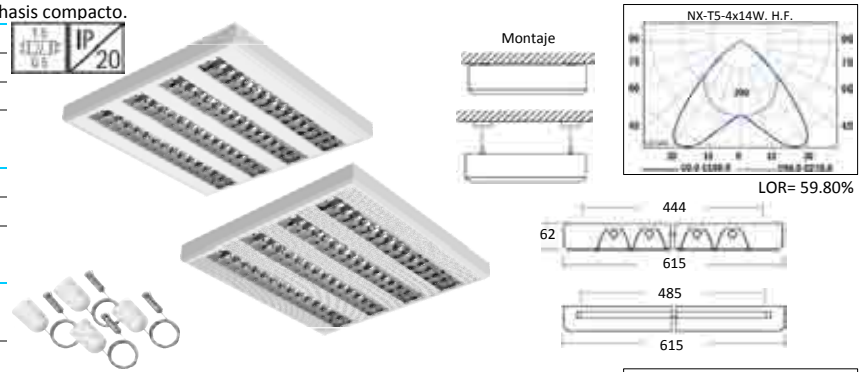

Materiales: Cuerpo en aluminio semibrillo anodizado, difusor lamas transversales.

CODIGO	REFERENCIA	P.V.P.	Kg.
036114228	ALUX-2x28W. H.F.	119,44 €	(2,6)
036114254	ALUX-2x54W. H.F.	119,44 €	(2,6)



ADOSABLES O SUSPENDIDAS T5 AREAS INDUSTRIALES

Materiales: Cuerpo en acero laminado en frío, reflector de aluminio anodizado brillante MIRO 4, óptica intensiva.

CODIGO	REFERENCIA	P.V.P.	Kg.
15120223328	POWER-REFLEX/COMPACT-3x28W. H.F.	457,65 €	7,0
15120223354	POWER-REFLEX/COMPACT-3x54W. H.F.	457,65 €	7,0
15120223335	POWER-REFLEX/COMPACT-3x35W. H.F.	468,35 €	8,2
15120223349	POWER-REFLEX/COMPACT-3x49W. H.F.	468,35 €	8,2
15120223380	POWER-REFLEX/COMPACT-3x80W. H.F.	506,69 €	8,2
15120223428	POWER-REFLEX/COMPACT-4x28W. H.F.	433,67 €	7,0
15120223454	POWER-REFLEX/COMPACT-4x54W. H.F.	433,67 €	7,0
15120223435	POWER-REFLEX/COMPACT-4x35W. H.F.	441,37 €	8,2
15120223449	POWER-REFLEX/COMPACT-4x49W. H.F.	441,37 €	8,2
15120223480	POWER-REFLEX/COMPACT-4x80W. H.F.	504,72 €	8,2
15120220001	CUBIERTA IP40 POWER-REFLEX/COMPACT-28/54W.	165,73 €	---
15120220002	CUBIERTA IP40 POWER-REFLEX/COMPACT-35/49/80W.	174,50 €	---

Cubierta-cierre IP40 abatible, en policarbonato transparente.

15620001	SISTEMA SUSPENSION CABLE RIGIDO MOD. 300	46,92 €	---
----------	---	----------------	-----

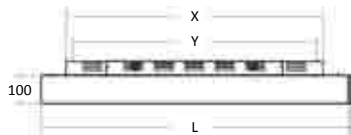
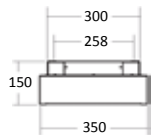

328/354/428/454W. - L=1215 X=1048 Y=1020
335/349/380/428/449/480W. - L=1515 X=1348

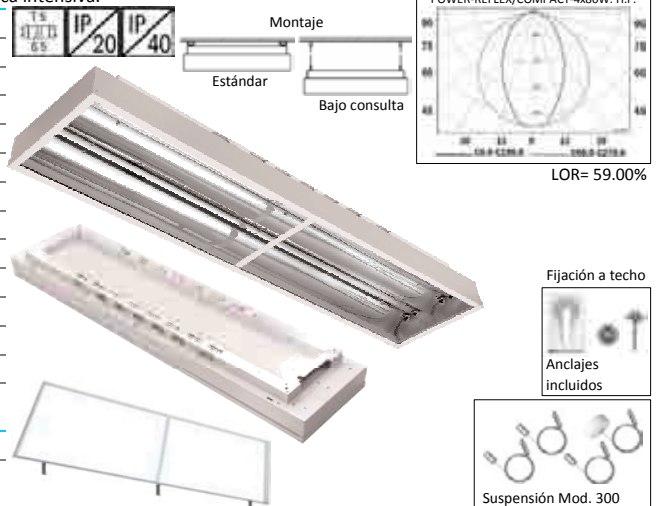

Materiales: Cuerpo en acero laminado en frío, reflector de aluminio anodizado brillante MIRO 4.

CODIGO	REFERENCIA	P.V.P.	Kg.
15120203454	POWER-REFLEX-4x54W. H.F.	519,39 €	12,0
15120203435	POWER-REFLEX-4x35W. H.F.	595,42 €	14,0
15120203449	POWER-REFLEX-4x49W. H.F.	595,42 €	14,0
15120203480	POWER-REFLEX-4x80W. H.F.	657,67 €	14,0
151202034120	POWER-REFLEX-4x120W. H.F.	777,06 €	14,0

POWER-REFLEX: Óptica intensiva.

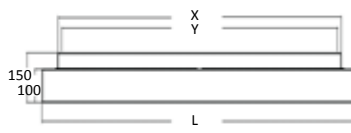
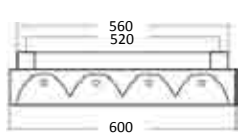

454W. - L=1215 X=1048 Y=1008
435/449/480/4120W. - L=1515 X=1348

15120213454	POWER-ULTRAREFLEX-4x54W. H.F.	503,06 €	12,0
15120213435	POWER-ULTRAREFLEX-4x35W. H.F.	627,69 €	14,0
15120213449	POWER-ULTRAREFLEX-4x49W. H.F.	627,69 €	14,0
15120213480	POWER-ULTRAREFLEX-4x80W. H.F.	689,90 €	14,0
151202134120	POWER-ULTRAREFLEX-4x120W. H.F.	809,29 €	14,0

POWER-ULTRAREFLEX: Óptica ultraintensiva.

15120200001	CUBIERTA IP40 POWER-REFLEX-4x54W.	199,72 €	---
15120200002	CUBIERTA IP40 POWER-REFLEX-4x35/49/80/120W.	216,57 €	---

Cubierta-cierre IP40 abatible, en policarbonato transparente.

15620001	SISTEMA SUSPENSION CABLE RIGIDO MOD. 300	46,92 €	---
----------	---	----------------	-----

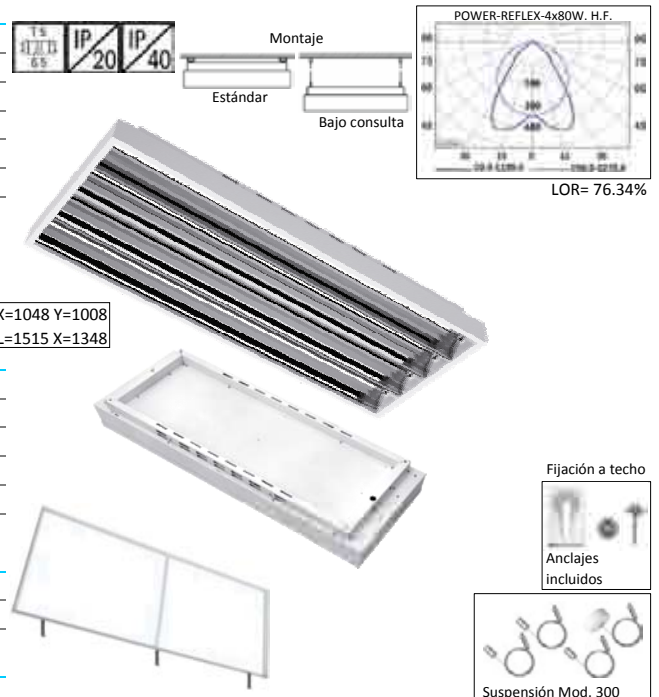

ADOSABLES IP54 BLANCAS

Materiales: Cuerpo en chapa de acero esmaltada en color blanco, difusor doble parabólico de aluminio brillante.

CODIGO	REFERENCIA	P.V.P.	Kg.
15423313318	N/BRPC-IP54-3x18W H.F.	346,91 €	(7,9)
15423313418	N/BRPC-IP54-4x18W H.F.	360,60 €	(7,9)
15423313236	N/BRPC-IP54-2x36W H.F.	350,55 €	(7,5)
15423313436	N/BRPC-IP54-4x36W H.F.	607,04 €	(14,5)
15423313314	N/BRPC-IP54-3x14W H.F.	346,91 €	(7,9)
15423313414	N/BRPC-IP54-4x14W H.F.	360,60 €	(7,9)
15423313324	N/BRPC-IP54-3x24W H.F.	361,55 €	(7,9)
15423313424	N/BRPC-IP54-4x24W H.F.	380,70 €	(7,9)
15423313228	N/BRPC-IP54-2x28W H.F.	350,55 €	(7,5)
15423313254	N/BRPC-IP54-2x54W H.F.	350,55 €	(7,5)
15423313428	N/BRPC-IP54-4x28W H.F.	607,04 €	(14,5)
15423313454	N/BRPC-IP54-4x54W H.F.	607,04 €	(14,5)
15423313340	N/BRPC-IP54-3x40W TC-L H.F.	406,64 €	(8,2)
15423313355	N/BRPC-IP54-3x55W TC-L H.F.	406,64 €	(8,2)

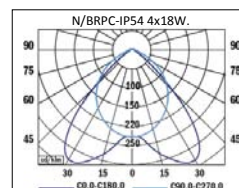
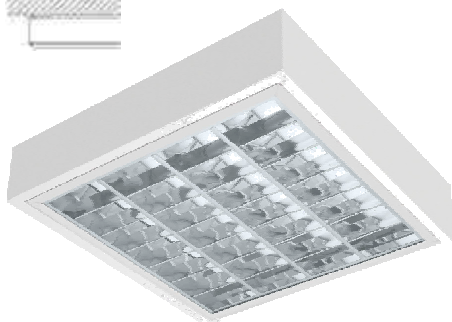
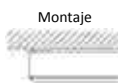

Materiales: Cuerpo en chapa de acero esmaltada en color blanco, difusor doble parabólico de aluminio satinado mate.

CODIGO	REFERENCIA	P.V.P.	Kg.
15423323318	N/MRPC-IP54-3x18W H.F.	348,44 €	(7,9)
15423323418	N/MRPC-IP54-4x18W H.F.	365,38 €	(7,9)
15423323236	N/MRPC-IP54-2x36W H.F.	353,99 €	(7,5)
15423323436	N/MRPC-IP54-4x36W H.F.	615,27 €	(14,5)
15423323314	N/MRPC-IP54-3x14W H.F.	348,44 €	(7,9)
15423323414	N/MRPC-IP54-4x14W H.F.	365,38 €	(7,9)
15423323324	N/MRPC-IP54-3x24W H.F.	367,58 €	(7,9)
15423323424	N/MRPC-IP54-4x24W H.F.	384,91 €	(7,9)
15423323228	N/MRPC-IP54-2x28W H.F.	353,99 €	(7,5)
15423323254	N/MRPC-IP54-2x54W H.F.	353,99 €	(7,5)
15423323428	N/MRPC-IP54-4x28W H.F.	615,27 €	(14,5)
15423323454	N/MRPC-IP54-4x54W H.F.	615,27 €	(14,5)
15423323340	N/MRPC-IP54-3x40W TC-L H.F.	412,67 €	(8,2)
15423323355	N/MRPC-IP54-3x55W TC-L H.F.	412,67 €	(8,2)

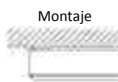

Materiales: Cuerpo en chapa de acero esmaltada en color blanco, difusor plancha opal policarbonato.

CODIGO	REFERENCIA	P.V.P.	Kg.
15423333318	N/OPALPC-IP54-3x18W H.F.	403,00 €	(7,3)
15423333418	N/OPALPC-IP54-4x18W H.F.	414,01 €	(7,3)
15423333236	N/OPALPC-IP54-2x36W H.F.	315,22 €	(6,9)
15423333436	N/OPALPC-IP54-4x36W H.F.	523,86 €	(13,9)
15423333314	N/OPALPC-IP54-3x14W H.F.	403,00 €	(7,3)
15423333414	N/OPALPC-IP54-4x14W H.F.	414,01 €	(7,3)
15423333324	N/OPALPC-IP54-3x24W H.F.	422,14 €	(7,3)
15423333424	N/OPALPC-IP54-4x24W H.F.	433,15 €	(7,3)
15423333228	N/OPALPC-IP54-2x28W H.F.	315,22 €	(6,9)
15423333254	N/OPALPC-IP54-2x54W H.F.	315,22 €	(6,9)
15423333428	N/OPALPC-IP54-4x28W H.F.	523,86 €	(13,9)
15423333454	N/OPALPC-IP54-4x54W H.F.	523,86 €	(13,9)
15423333340	N/OPALPC-IP54-3x40W TC-L H.F.	465,50 €	(7,6)
15423333355	N/OPALPC-IP54-3x55W TC-L H.F.	465,50 €	(7,6)

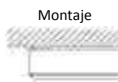

Materiales: Cuerpo en chapa de acero esmaltada en color blanco, difusor plancha prisma policarbonato.

CODIGO	REFERENCIA	P.V.P.	Kg.
15423343318	N/PRISMAPC-IP54-3x18W H.F.	353,77 €	(7,0)
15423343418	N/PRISMAPC-IP54-4x18W H.F.	264,21 €	(7,0)
15423343236	N/PRISMAPC-IP54-2x36W H.F.	256,17 €	(6,6)
15423343436	N/PRISMAPC-IP54-4x36W H.F.	412,53 €	(13,6)
15423343314	N/PRISMAPC-IP54-3x14W H.F.	253,77 €	(7,0)
15423343414	N/PRISMAPC-IP54-4x14W H.F.	264,21 €	(7,0)
15423343324	N/PRISMAPC-IP54-3x24W H.F.	272,92 €	(7,0)
15423343424	N/PRISMAPC-IP54-4x24W H.F.	283,73 €	(7,0)
15423343228	N/PRISMAPC-IP54-2x28W H.F.	256,17 €	(6,6)
15423343254	N/PRISMAPC-IP54-2x54W H.F.	256,17 €	(6,6)
15423343428	N/PRISMAPC-IP54-4x28W H.F.	412,53 €	(13,6)
15423343454	N/PRISMAPC-IP54-4x54W H.F.	412,53 €	(13,6)
15423343340	N/PRISMAPC-IP54-3x40W TC-L H.F.	313,50 €	(7,3)
15423343355	N/PRISMAPC-IP54-3x55W TC-L H.F.	313,50 €	(7,3)

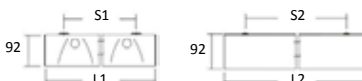
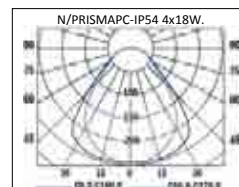
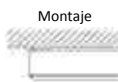
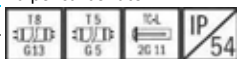

318/418W. - L1=618 L2= 618 S1=500 S2=500
236W. - L1=328 L2=1228 S1=109 S2=984
436W. - L1=628 L2=1228 S1=500 S2=984
314/414/324/424W. - L1=618 L2= 618 S1=500 S2=500
228/254W. - L1=328 L2=1228 S1=109 S2=984
428/454W. - L1=628 L2=1228 S1=500 S2=984
340/355W. TC-L - L1=618 L2= 618 S1=500 S2=500

ADOSABLES T-8

Materiales: Cuerpo en chapa de acero, difusor de aluminio parabólico brillante con transversales escalonadas.

CODIGO	REFERENCIA	P.V.P.	Kg.
15128122363	MN/EXTL-2x36W. 230V. A.F.	73,28 €	(4,8)
15128124183	MN/EXTL-4x18W. 230V. A.F.	73,48 €	(4,3)

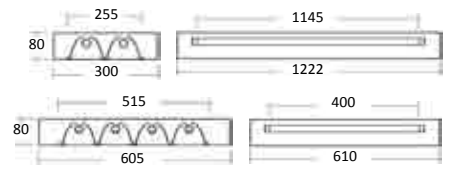

Materiales: Cuerpo en chapa de acero, difusor de aluminio parabólico brillante con transversales escalonadas.

CODIGO	REFERENCIA	P.V.P.	Kg.
1512812218	N/EXT-2x18W. 230V. A.F.	52,65 €	(2,7)
1512812236	N/EXT-2x36W. 230V. A.F.	94,74 €	(4,7)
1512812258	N/EXT-2x58W. 230V. A.F.	113,63 €	(6,2)
1512812418	N/EXT-4x18W. 230V. A.F.	96,57 €	(4,6)
1512812436	N/EXT-4x36W. 230V. A.F.	168,91 €	(8,8)
1512813218	N/EXT-2x18W. H.F.	77,68 €	(2,3)
1512813236	N/EXT-2x36W. H.F.	115,46 €	(4,1)
1512813258	N/EXT-2x58W. H.F.	122,70 €	(5,0)
1512813418	N/EXT-4x18W. H.F.	122,03 €	(4,0)
1512813436	N/EXT-4x36W. H.F.	210,33 €	(7,1)

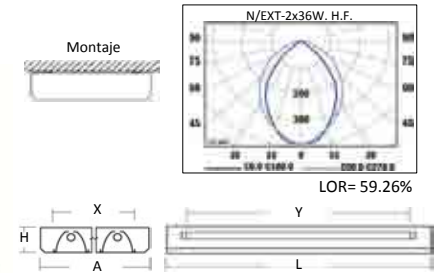
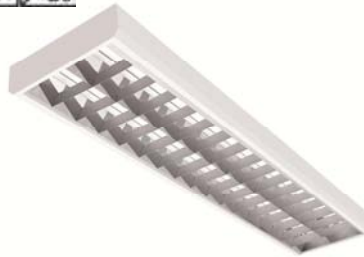

218W. - A=290, L= 614, X=203, Y= 510, H=67
236W. - A=290, L=1235, X=206, Y= 948, H=67
258W. - A=290, L=1535, X=206, Y=1379, H=67
418W. - A=615, L= 625, X=519, Y= 342, H=67
436W. - A=623, L=1250, X=518, Y= 950, H=84

Materiales: Cuerpo en chapa de acero, difusor de aluminio parabólico blanco con transversales escalonadas.

CODIGO	REFERENCIA	P.V.P.	Kg.
1512822218	N/LV-2x18W. 230V. A.F.	54,41 €	(2,7)
1512822236	N/LV-2x36W. 230V. A.F.	96,46 €	(4,7)
1512822258	N/LV-2x58W. 230V. A.F.	115,78 €	(6,2)
1512822418	N/LV-4x18W. 230V. A.F.	98,29 €	(4,6)
1512822436	N/LV-4x36W. 230V. A.F.	176,81 €	(8,8)
1512823218	N/LV-2x18W. H.F.	78,97 €	(2,3)
1512823236	N/LV-2x36W. H.F.	116,75 €	(4,1)
1512823258	N/LV-2x58W. H.F.	124,85 €	(5,0)
1512823418	N/LV-4x18W. H.F.	123,75 €	(4,0)
1512823436	N/LV-4x36W. H.F.	219,52 €	(7,1)

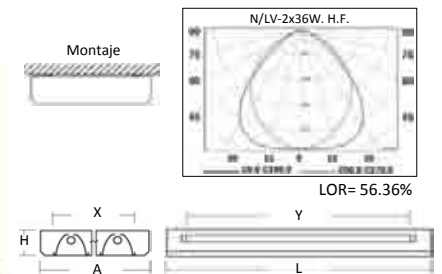

218W. - A=290, L= 614, X=203, Y= 510, H=67
236W. - A=290, L=1235, X=206, Y= 948, H=67
258W. - A=290, L=1535, X=206, Y=1379, H=67
418W. - A=615, L= 625, X=519, Y= 342, H=67
436W. - A=623, L=1250, X=518, Y= 950, H=84

Materiales: Cuerpo en chapa de acero, difusor plancha prisma.

CODIGO	REFERENCIA	P.V.P.	Kg.
1512872218	N/PRISMA-2x18W. 230V. A.F.	56,56 €	(3,2)
1512872236	N/PRISMA-2x36W. 230V. A.F.	93,02 €	(5,6)
1512872258	N/PRISMA-2x58W. 230V. A.F.	115,35 €	(7,4)
1512872418	N/PRISMA-4x18W. 230V. A.F.	94,85 €	(5,6)
1512872436	N/PRISMA-4x36W. 230V. A.F.	168,64 €	(10,6)
1512873218	N/PRISMA-2x18W. H.F.	81,55 €	(2,8)
1512873236	N/PRISMA-2x36W. H.F.	112,84 €	(5,0)
1512873258	N/PRISMA-2x58W. H.F.	124,42 €	(6,2)
1512873418	N/PRISMA-4x18W. H.F.	120,31 €	(5,0)
1512873436	N/PRISMA-4x36W. H.F.	211,31 €	(8,9)

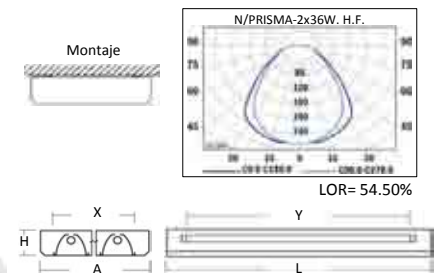

218W. - A=290, L= 620, X=205, Y= 460, H=84
236W. - A=290, L=1250, X=205, Y=1070, H=84
258W. - A=290, L=1550, X=205, Y=1370, H=84
418W. - A=623, L= 623, X=518, Y= 340, H=84
436W. - A=623, L=1250, X=518, Y= 950, H=84

Materiales: Cuerpo en chapa de acero, difusor plancha opal.

CODIGO	REFERENCIA	P.V.P.	Kg.
1512882218	N/OPAL-2x18W. 230V. A.F.	60,43 €	(3,2)
1512882236	N/OPAL-2x36W. 230V. A.F.	104,67 €	(5,6)
1512882258	N/OPAL-2x58W. 230V. A.F.	130,01 €	(7,4)
1512882418	N/OPAL-4x18W. 230V. A.F.	111,24 €	(5,6)
1512882436	N/OPAL-4x36W. 230V. A.F.	194,49 €	(10,6)
1512883218	N/OPAL-2x18W. H.F.	85,42 €	(2,8)
1512883236	N/OPAL-2x36W. H.F.	124,93 €	(5,0)
1512883258	N/OPAL-2x58W. H.F.	138,66 €	(6,2)
1512883418	N/OPAL-4x18W. H.F.	136,66 €	(5,0)
1512883436	N/OPAL-4x36W. H.F.	237,63 €	(8,9)

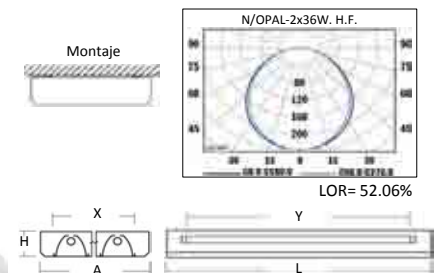

218W. - A=290, L= 620, X=205, Y= 460, H=84
236W. - A=290, L=1250, X=205, Y=1070, H=84
258W. - A=290, L=1550, X=205, Y=1370, H=84
418W. - A=623, L= 623, X=518, Y= 340, H=84
436W. - A=623, L=1250, X=518, Y= 950, H=84

ADOSABLES T-8

Materiales: Cuerpo en chapa de acero, difusor de aluminio doble parabólico brillante.

CODIGO	REFERENCIA	P.V.P.	Kg.
15128322363	MN/BRL-2x36W. 230V. A.F.	77,96 €	(4,8)
15128324183	MN/BRL-4x18W. 230V. A.F.	83,04 €	(4,3)

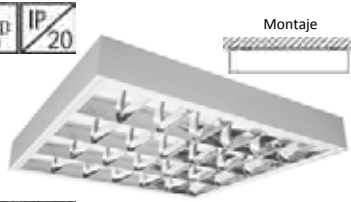

Materiales: Cuerpo en chapa de acero, difusor de aluminio doble parabólico brilla

CODIGO	REFERENCIA	P.V.P.	Kg.
1512832218	N/BR-2x18W. 230V. A.F.	58,28 €	(3,2)
1512832236	N/BR-2x36W. 230V. A.F.	101,31 €	(6,7)
1512832258	N/BR-2x58W. 230V. A.F.	126,05 €	(7,9)
1512832418	N/BR-4x18W. 230V. A.F.	109,52 €	(6,2)
1512832436	N/BR-4x36W. 230V. A.F.	193,36 €	(11,7)
1512833218	N/BR-2x18W. H.F.	84,58 €	(2,8)
1512833236	N/BR-2x36W. H.F.	120,76 €	(6,0)
1512833258	N/BR-2x58W. H.F.	134,76 €	(6,4)
1512833418	N/BR-4x18W. H.F.	135,37 €	(5,6)
1512833436	N/BR-4x36W. H.F.	234,73 €	(10,0)

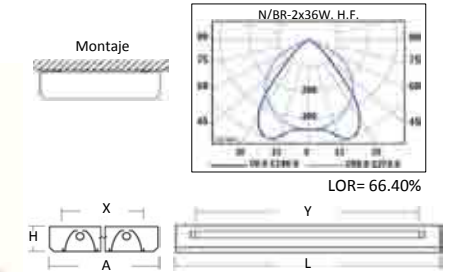

218W.	- A=290, L= 620, X=205, Y= 460, H=84
236W.	- A=291, L=1236, X=206, Y=1080, H=90
258W.	- A=291, L=1536, X=206, Y=1379, H=90
418W.	- A=615, L= 625, X=519, Y= 342, H=90
436W.	- A=623, L=1250, X=518, Y= 950, H=84

Materiales: Cuerpo en chapa de acero, difusor de aluminio doble parabólico mate.

CODIGO	REFERENCIA	P.V.P.	Kg.
1512842218	N/MR-2x18W. 230V. A.F.	63,44 €	(3,2)
1512842236	N/MR-2x36W. 230V. A.F.	117,61 €	(6,7)
1512842258	N/MR-2x58W. 230V. A.F.	140,13 €	(7,9)
1512842418	N/MR-4x18W. 230V. A.F.	121,60 €	(6,2)
1512842436	N/MR-4x36W. 230V. A.F.	216,52 €	(11,7)
1512843218	N/MR-2x18W. H.F.	88,90 €	(2,8)
1512843236	N/MR-2x36W. H.F.	137,44 €	(6,0)
1512843258	N/MR-2x58W. H.F.	148,39 €	(6,4)
1512843418	N/MR-4x18W. H.F.	147,45 €	(5,6)
1512843436	N/MR-4x36W. H.F.	257,52 €	(10,0)

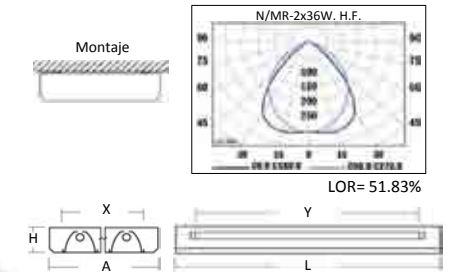

218W.	- A=290, L= 620, X=205, Y= 460, H=84
236W.	- A=291, L=1236, X=206, Y=1080, H=90
258W.	- A=291, L=1536, X=206, Y=1379, H=90
418W.	- A=615, L= 625, X=519, Y= 342, H=90
436W.	- A=623, L=1250, X=518, Y= 950, H=84

Materiales: Cuerpo en chapa de acero, difusor parabólico brillante con transversales escalonadas.

CODIGO	REFERENCIA	P.V.P.	Kg.
1512942118	MN/T8/EXT-1x18W. 230V. A.F.	44,92 €	(2,5)
1512942136	MN/T8/EXT-1x36W. 230V. A.F.	66,39 €	(4,4)
1512942158	MN/T8/EXT-1x58W. 230V. A.F.	82,88 €	(5,9)
1512942218	MN/T8/EXT-2x18W. 230V. A.F.	47,18 €	(2,6)
1512942236	MN/T8/EXT-2x36W. 230V. A.F.	79,42 €	(5,0)
1512942258	MN/T8/EXT-2x58W. 230V. A.F.	101,55 €	(6,8)
1512943118	MN/T8/EXT-1x18W.H.F.	66,42 €	(2,1)
1512943136	MN/T8/EXT-1x36W.H.F.	84,61 €	(4,4)
1512943158	MN/T8/EXT-1x58W.H.F.	97,06 €	(5,2)
1512943218	MN/T8/EXT-2x18W.H.F.	73,27 €	(2,2)
1512943236	MN/T8/EXT-2x36W.H.F.	89,57 €	(4,1)
1512943258	MN/T8/EXT-2x58W.H.F.	104,44 €	(5,1)

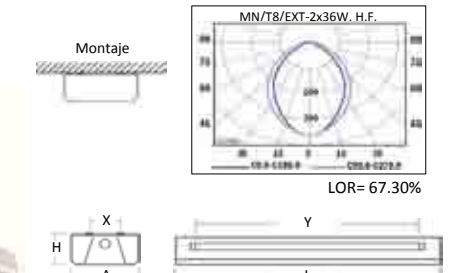

118/218W.	- A=210, L= 625, X=118, Y= 433, H=80
136/236W.	- A=210, L=1235, X=118, Y=1043, H=80
158/258W.	- A=210, L=1535, X=118, Y=1343, H=80

ADOSABLES T-5

Materiales: Cuerpo en chapa de acero, difusor parabólico brillante con transversales escalonadas.

CODIGO	REFERENCIA	P.V.P.	Kg.
1562025114	MN/T5/EXT-1x14W. H.F.	79,70 €	(2,1)
1562025124	MN/T5/EXT-1x24W. H.F.	79,70 €	(2,1)
1562025128	MN/T5/EXT-1x28W. H.F.	93,01 €	(4,0)
1562025154	MN/T5/EXT-1x54W. H.F.	93,01 €	(4,0)
1562025135	MN/T5/EXT-1x35W. H.F.	103,72 €	(5,2)
1562025149	MN/T5/EXT-1x49W. H.F.	103,72 €	(5,2)
1562025180	MN/T5/EXT-1x80W. H.F.	120,18 €	(5,2)
1562025214	MN/T5/EXT-2x14W. H.F.	85,94 €	(2,2)
1562025224	MN/T5/EXT-2x24W. H.F.	85,94 €	(2,2)
1562025228	MN/T5/EXT-2x28W. H.F.	101,87 €	(4,1)
1562025254	MN/T5/EXT-2x54W. H.F.	101,87 €	(4,1)
1562025235	MN/T5/EXT-2x35W. H.F.	112,37 €	(5,1)
1562025249	MN/T5/EXT-2x49W. H.F.	112,37 €	(5,1)
1562025280	MN/T5/EXT-2x80W. H.F.	183,15 €	(5,1)

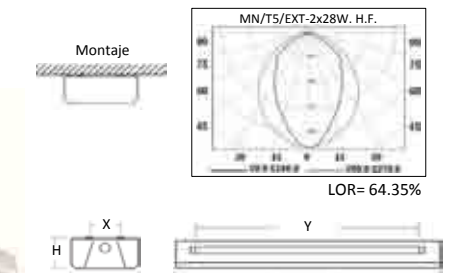

114/124/214/224W.	- A=210, L= 625, X=118, Y= 433, H=80
128/154/228/254W.	- A=210, L=1235, X=118, Y=1043, H=80
135/149/180/235/249/280W.	- A=210, L=1535, X=118, Y=1343, H=80

ADOSABLES T-5 AREAS DEPORTIVAS

Materiales: Cuerpo en chapa de acero, difusor de aluminio doble parabólico brillante con plancha transparente de policarbonato.

CODIGO	REFERENCIA	P.V.P.	Kg.
1512013328	IMPACT-IP44-3x28W. H.F.	394,53 €	(9,3)
1512013354	IMPACT-IP44-3x54W. H.F.	394,53 €	(9,3)
1512013335	IMPACT-IP44-3x35W. H.F.	432,09 €	(11,3)
1512013349	IMPACT-IP44-3x49W. H.F.	432,09 €	(11,3)
1512013380	IMPACT-IP20-3x80W. H.F.	548,93 €	(11,3)

Debido a la temperatura de funcionamiento, el modelo 3x80W. incorpora ranuras de aireación.

Sistema de suspensión cable rígido, bajo consulta.

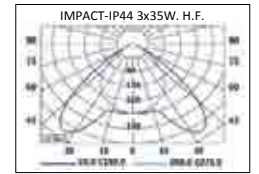
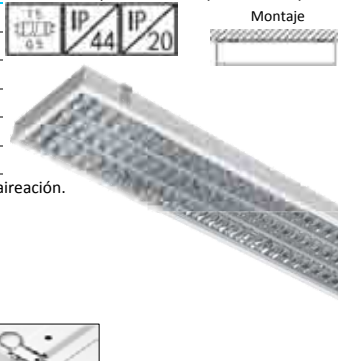

LOR= 50.76%

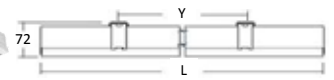
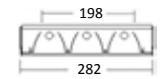

328/354W. - L=1206, Y= 980
335/349/380W. - L=1506, Y=1280

ADOSABLES T-5

Materiales: Cuerpo en chapa de acero, difusor de policarbonato opal o prismático.

CODIGO	REFERENCIA	P.V.P.	Kg.
030243214	OPTIMA/OPAL-2x14W. H.F.	105,55 €	(2,0)
030243228	OPTIMA/OPAL-2x28W. H.F.	107,12 €	(2,6)
030243235	OPTIMA/OPAL-2x35W. H.F.	128,48 €	(3,2)
030243249	OPTIMA/OPAL-2x49W. H.F.	128,48 €	(3,2)
030253214	OPTIMA/PRISMA-2x14W. H.F.	104,19 €	(2,0)
030253228	OPTIMA/PRISMA-2x28W. H.F.	105,06 €	(2,6)
030253235	OPTIMA/PRISMA-2x35W. H.F.	124,12 €	(3,2)
030253249	OPTIMA/PRISMA-2x49W. H.F.	124,12 €	(3,2)

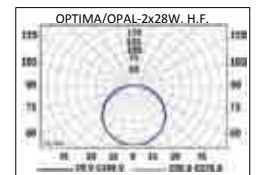

LOR= 62.16%

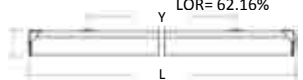

214W. - L= 594, Y= 400
228W. - L=1194, Y=1000
235/249W. - L=1494, Y=1300

Materiales: Cuerpo en chapa de acero, difusor de metacrilato de metilo prismático.

CODIGO	REFERENCIA	P.V.P.	Kg.
03026013218	NOVA/OPAL-2x18W. H.F.	53,81 €	(1,6)
03026013236	NOVA/OPAL-2x36W. H.F.	73,38 €	(3,1)
03026013258	NOVA/OPAL-2x58W. H.F.	83,17 €	(4,4)
03026023218	NOVA/PRISMA-2x18W. H.F.	53,81 €	(1,6)
03026023236	NOVA/PRISMA-2x36W. H.F.	73,38 €	(3,1)
03026023258	NOVA/PRISMA-2x58W. H.F.	83,17 €	(4,4)

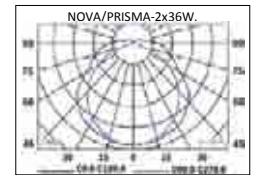
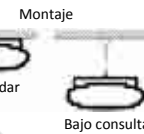

218W. - L= 683, Y= 500
236W. - L=1293, Y= 800
258W. - L=1593, Y=1000



Líneas continuas bajo consulta.

15620002	SET DE SUSPENSION (BAJO PEDIDO, JUEGO 2 UDS.)	31,18 €	---
----------	--	---------	-----

ADOSABLES T-8

Materiales: Cuerpo en chapa de acero, difusor de metacrilato de metilo prismático.

CODIGO	REFERENCIA	P.V.P.	Kg.
030221218	KTX/N-2x18W. 230V. B.F.	30,45 €	(1,8)
030221236	KTX/N-2x36W. 230V. B.F.	46,68 €	(3,6)
030221258	KTX/N-2x58W. 230V. B.F.	65,08 €	(4,7)
030222118	KTX/N-1x18W. 230V. A.F.	28,50 €	(1,4)
030222136	KTX/N-1x36W. 230V. A.F.	36,86 €	(2,0)
030222158	KTX/N-1x58W. 230V. A.F.	48,07 €	(2,6)
030222218	KTX/N-2x18W. 230V. A.F.	32,78 €	(1,9)
030222236	KTX/N-2x36W. 230V. A.F.	49,75 €	(3,7)
030222258	KTX/N-2x58W. 230V. A.F.	68,60 €	(4,8)
030223118	KTX/N-1x18W. H.F.	60,87 €	(1,1)
030223136	KTX/N-1x36W. H.F.	64,45 €	(1,7)
030223158	KTX/N-1x58W. H.F.	70,27 €	(2,2)
030223218	KTX/N-2x18W. H.F.	63,13 €	(1,5)
030223236	KTX/N-2x36W. H.F.	69,53 €	(2,7)
030223258	KTX/N-2x58W. H.F.	74,16 €	(3,1)

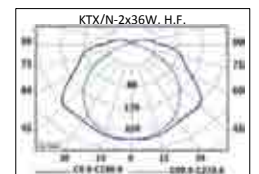
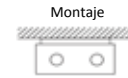
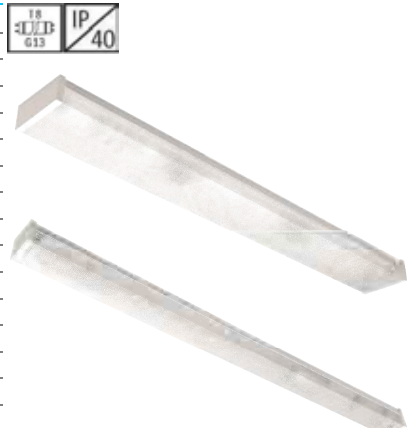

LOR= 68.10%

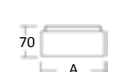

118W. - A= 70, L= 625, Y= 415
136W. - A= 70, L=1255, Y=1040
158W. - A= 70, L=1535, Y=1320
218W. - A=150, L= 625, Y= 437
136W. - A=150, L=1255, Y=1040
158W. - A=150, L=1535, Y=1320

Materiales: Cuerpo en chapa de acero, difusor de aluminio parabólico blanco con transversales planas.

3002310220	EU-2x18W. 230V. B.F.	28,50 €	(2,6)
------------	----------------------	---------	-------

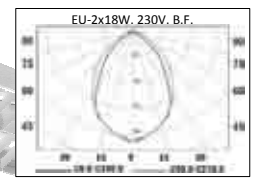
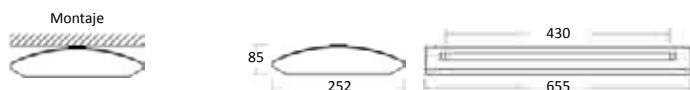

LOR= 59.82%

ADOSABLES ULTIMA GENERACION T5-FC

Materiales: Cuerpo en chapa de acero, anillo reflector de aluminio brillante, difusor PMMA opal. Techos armstrong.

CODIGO	REFERENCIA	P.V.P.	Kg.
15128513040	PYRAMIDE/S-OPAL-IN - 40W. H.F.	320,19 €	(4,9)
15128513055	PYRAMIDE/S-OPAL-IN - 55W. H.F.	355,02 €	(4,9)
15128513060	PYRAMIDE/S-OPAL-IN - 60W. H.F.	357,75 €	(4,9)
15128513422	PYRAMIDE/S-OPAL-IN - 40+22W. H.F.	373,39 €	(4,9)
15128513522	PYRAMIDE/S-OPAL-IN - 55+22W. H.F.	408,26 €	(4,9)
15128513622	PYRAMIDE/S-OPAL-IN - 60+22W. H.F.	411,51 €	(4,9)
<hr/>			
15620001	SET DE SUSPENSION (BAJO PEDIDO, JUEGO 4 UDS.)	31,18 €	---

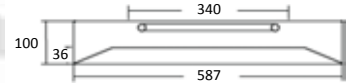
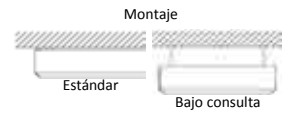

Materiales: Cuerpo en chapa de acero, anillo reflector de aluminio brillante, difusor PMMA opal. Techos armstrong.

CODIGO	REFERENCIA	P.V.P.	Kg.
15128503040	PYRAMIDE/S-OPAL-OUT - 40W. H.F.	320,19 €	(4,9)
15128503055	PYRAMIDE/S-OPAL-OUT - 55W. H.F.	355,02 €	(4,9)
15128503060	PYRAMIDE/S-OPAL-OUT - 60W. H.F.	357,75 €	(4,9)
15128503422	PYRAMIDE/S-OPAL-OUT - 40+22W. H.F.	373,39 €	(4,9)
15128503522	PYRAMIDE/S-OPAL-OUT - 55+22W. H.F.	408,26 €	(4,9)
15128503622	PYRAMIDE/S-OPAL-OUT - 60+22W. H.F.	411,51 €	(4,9)
<hr/>			
15620001	SET DE SUSPENSION (BAJO PEDIDO, JUEGO 4 UDS.)	31,18 €	---

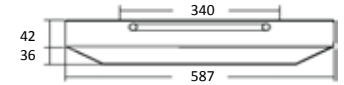
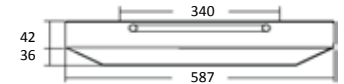
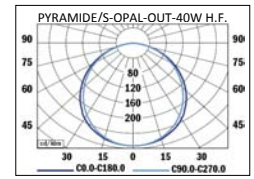
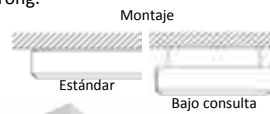

Materiales: Cuerpo en chapa de acero, anillo reflector de aluminio brillante, difusor PMMA prismático. Techos armstrong.

CODIGO	REFERENCIA	P.V.P.	Kg.
15128613040	PYRAMIDE/S-PRISMA-IN - 40W. H.F.	287,88 €	(4,9)
15128613055	PYRAMIDE/S-PRISMA-IN - 55W. H.F.	322,75 €	(4,9)
15128613060	PYRAMIDE/S-PRISMA-IN - 60W. H.F.	332,93 €	(4,9)
15128613422	PYRAMIDE/S-PRISMA-IN - 40+22W. H.F.	341,12 €	(4,9)
15128613522	PYRAMIDE/S-PRISMA-IN - 55+22W. H.F.	375,95 €	(4,9)
15128613622	PYRAMIDE/S-PRISMA-IN - 60+22W. H.F.	379,24 €	(4,9)
<hr/>			
15620001	SET DE SUSPENSION (BAJO PEDIDO, JUEGO 4 UDS.)	31,18 €	---

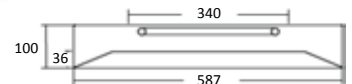
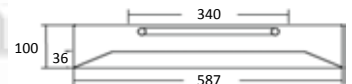
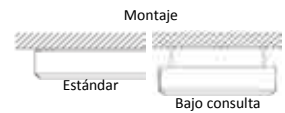

Materiales: Cuerpo en chapa de acero, anillo reflector de aluminio brillante, difusor PMMA prismático. Techos armstrong.

CODIGO	REFERENCIA	P.V.P.	Kg.
15128603040	PYRAMIDE/S-PRISMA-OUT - 40W. H.F.	287,88 €	(4,9)
15128603055	PYRAMIDE/S-PRISMA-OUT - 55W. H.F.	322,75 €	(4,9)
15128603060	PYRAMIDE/S-PRISMA-OUT - 60W. H.F.	332,93 €	(4,9)
15128603422	PYRAMIDE/S-PRISMA-OUT - 40+22W. H.F.	341,12 €	(4,9)
15128603522	PYRAMIDE/S-PRISMA-OUT - 55+22W. H.F.	375,95 €	(4,9)
15128603622	PYRAMIDE/S-PRISMA-OUT - 60+22W. H.F.	379,24 €	(4,9)
<hr/>			
15620001	SET DE SUSPENSION (BAJO PEDIDO, JUEGO 4 UDS.)	31,18 €	---

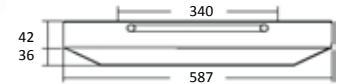
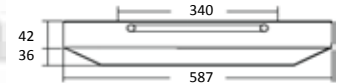
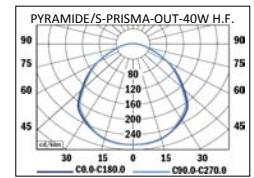
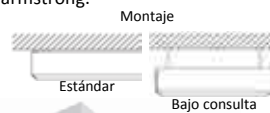
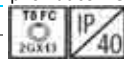

ASIMÉTRICAS ADOSABLES / EMPOTRABLES BAÑADORES DE PARED

Materiales: Luminaria bañador de pared adosable en chapa de acero, difusor prismático para iluminación indirecta y microperforado para iluminación directa.

CODIGO	REFERENCIA	P.V.P.	Kg.
1372912118	COMET-1x18W. G13 230V. A.F.	96,92 €	(1,6)
1372912136	COMET-1x36W. G13 230V. A.F.	164,98 €	(3,1)
1372912158	COMET-1x58W. G13 230V. A.F.	197,12 €	(3,9)
1372913118	COMET-1x18W. G13 H.F.	114,66 €	(1,2)
1372913136	COMET-1x36W. G13 H.F.	183,45 €	(2,6)
1372913158	COMET-1x58W. G13 H.F.	209,31 €	(3,4)
1372913236	COMET-2x36W. 2G11 H.F.	197,24 €	(3,0)
1372913255	COMET-2x55W. 2G11 H.F.	197,24 €	(3,0)
1372912118G	COMET/GRIS-1x18W. G13 230V. A.F.	113,81 €	(1,6)
1372912136G	COMET/GRIS-1x36W. G13 230V. A.F.	181,88 €	(3,1)
1372912158G	COMET/GRIS-1x58W. G13 230V. A.F.	214,02 €	(3,9)
1372913118G	COMET/GRIS-1x18W. G13 H.F.	131,55 €	(1,2)
1372913136G	COMET/GRIS-1x36W. G13 H.F.	200,34 €	(2,6)
1372913158G	COMET/GRIS-1x58W. G13 H.F.	226,20 €	(3,4)
1372913236G	COMET/GRIS-2x36W. 2G11 H.F.	214,14 €	(3,0)
1372913255G	COMET/GRIS-2x55W. 2G11 H.F.	214,14 €	(3,0)

Modelos T-5 bajo consulta.

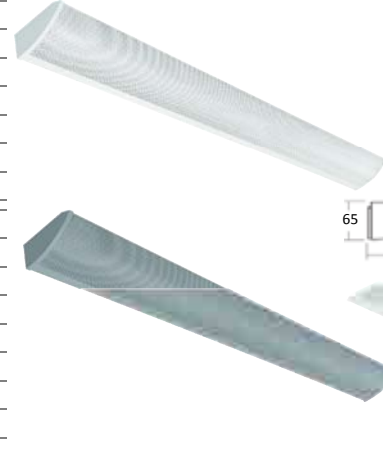

Montaje

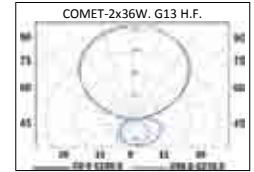

LOR= 60.99%



118W. G13 - L= 645, Y= 490
136W. G13 - L=1255, Y=1095
158W. G13 - L=1555, Y=1392
236/255W. 2G11 - L=1255, Y=1095

Materiales: Luminaria adosable en chapa de acero, reflector de aluminio asimétrico.

CODIGO	REFERENCIA	P.V.P.	Kg.
1542702136	ASYM/S-1x36W. 230V. A.F.	79,54 €	(4,0)
1542702158	ASYM/S-1x58W. 230V. A.F.	103,88 €	(5,0)
1542703136	ASYM/S-1x36W. H.F.	104,96 €	(3,5)
1542703158	ASYM/S-1x58W. H.F.	117,62 €	(4,5)
1542702136G	ASYM/S/GRIS-1x36W. 230V. A.F.	98,64 €	(4,0)
1542702158G	ASYM/S/GRIS-1x58W. 230V. A.F.	122,98 €	(5,0)
1542703136G	ASYM/S/GRIS-1x36W. H.F.	123,15 €	(3,5)
1542703158G	ASYM/S/GRIS-1x58W. H.F.	135,81 €	(4,5)



Montaje

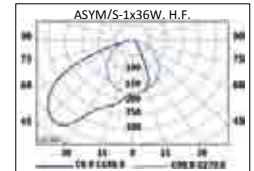
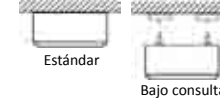

LOR= 62.49%



136W. - L=1235, Y=1050
158W. - L=1545, Y=1370

Materiales: Luminaria adosable en chapa de acero, reflector de aluminio asimétrico.

CODIGO	REFERENCIA	P.V.P.	Kg.
1542703128	ASYM-T5/S-1x28W. H.F.	122,31 €	(3,5)
1542703154	ASYM-T5/S-1x54W. H.F.	122,31 €	(3,5)
1542703135	ASYM-T5/S-1x35W. H.F.	136,63 €	(4,5)
1542703149	ASYM-T5/S-1x49W. H.F.	136,63 €	(4,5)
1542703180	ASYM-T5/S-1x80W. H.F.	150,54 €	(4,5)
1542703128G	ASYM-T5/S/GRIS-1x28W. H.F.	140,51 €	(3,5)
1542703154G	ASYM-T5/S/GRIS-1x54W. H.F.	140,51 €	(3,5)
1542703135G	ASYM-T5/S/GRIS-1x35W. H.F.	154,83 €	(4,5)
1542703149G	ASYM-T5/S/GRIS-1x49W. H.F.	154,83 €	(4,5)
1542703180G	ASYM-T5/S/GRIS-1x80W. H.F.	168,73 €	(4,5)

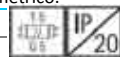

Montaje

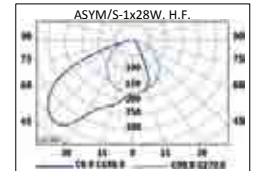
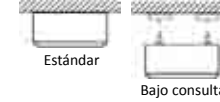

LOR= 62.49%



128/154W. - L=1235, Y=1050
135/149/180W. - L=1545, Y=1370

Materiales: Luminaria empotrable techos lisos en chapa de acero, reflector de aluminio asimétrico.

CODIGO	REFERENCIA	P.V.P.	Kg.
1542712118	ASYM/PTE-1x18W. 230V. A.F.	71,92 €	(3,0)
1542712136	ASYM/PTE-1x36W. 230V. A.F.	81,28 €	(4,0)
1542713118	ASYM/PTE-1x18W. H.F.	101,11 €	(3,0)
1542713136	ASYM/PTE-1x36W. H.F.	108,76 €	(4,0)
1542712118G	ASYM/PTE/GRIS-1x18W. 230V. A.F.	92,62 €	(3,0)
1542712136G	ASYM/PTE/GRIS-1x36W. 230V. A.F.	100,99 €	(4,0)
1542713118G	ASYM/PTE/GRIS-1x18W. H.F.	120,82 €	(3,0)
1542713136G	ASYM/PTE/GRIS-1x36W. H.F.	128,47 €	(4,0)



Montaje

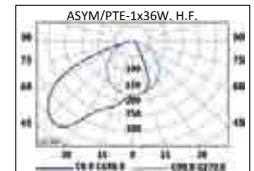

LOR= 62.49%



118W. - L= 620
136W. - L=1220

Materiales: Luminaria empotrable techos lisos en chapa de acero, reflector de aluminio asimétrico.

CODIGO	REFERENCIA	P.V.P.	Kg.
1542713114	ASYM-T5/PTE-1x14W. H.F.	110,21 €	(2,0)
1542713124	ASYM-T5/PTE-1x24W. H.F.	110,21 €	(2,0)
1542713128	ASYM-T5/PTE-1x28W. H.F.	125,45 €	(3,5)
1542713154	ASYM-T5/PTE-1x54W. H.F.	125,45 €	(3,5)
1542713114G	ASYM-T5/PTE/GRIS-1x14W. H.F.	129,92 €	(2,0)
1542713124G	ASYM-T5/PTE/GRIS-1x24W. H.F.	129,92 €	(2,0)
1542713128G	ASYM-T5/PTE/GRIS-1x28W. H.F.	145,16 €	(3,5)
1542713154G	ASYM-T5/PTE/GRIS-1x54W. H.F.	145,16 €	(3,5)

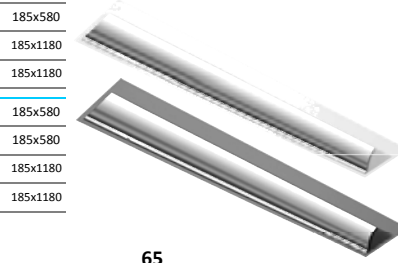

Montaje

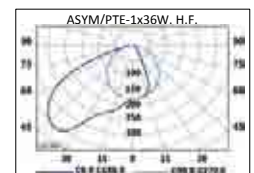



LOR= 62.49%



114/124W. - L= 620
128/154W. - L=1220

ADOSABLES CIRCULARES / SUSPENDIDOS CIRCULARES

Materiales: Cuerpo en policarbonato, difusor de policarbonato prismático.

CODIGO	REFERENCIA	Indice rendimiento de color CRI (Ra)	Temperatura de color CCT (k)	P.V.P.	Kg.	 
160291L150	CIRCLINE LED-16W. 1500lm/840	>80	4000	432,31 €	(3,5)	

Detector de presencia bajo consulta.

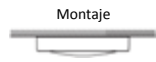

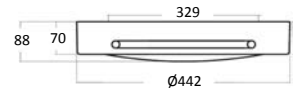

160292L150G	CIRCLINE LED/GRIS-16W. 1500lm/840	>80	4000	451,81 €	(3,5)	
-------------	--	-----	------	-----------------	-------	--

Detector de presencia bajo consulta.



Materiales: Cuerpo en policarbonato, difusor de policarbonato prismático.

CODIGO	REFERENCIA	Indice rendimiento de color CRI (Ra)	Temperatura de color CCT (k)	P.V.P.	Kg.	 
160292L150	CIRCLINE PENDULAR LED-16W. 1500lm/840	>80	4000	451,70 €	(3,5)	

Suspensiones incluidas.

Detector de presencia bajo consulta.

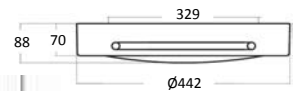
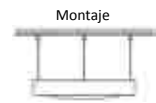



160292L150G	CIRCLINE PENDULAR LED/GRIS-16W. 1500lm/840	>80	4000	471,20 €	(3,5)	
-------------	---	-----	------	-----------------	-------	--

Suspensiones incluidas.

Detector de presencia bajo consulta.

ADOSABLES CIRCULARES T5-FC / SUSPENDIDOS CIRCULARES T5-FC

Materiales: Cuerpo en policarbonato, difusor de policarbonato prismático.

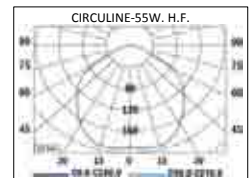
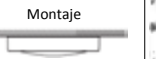

CODIGO	REFERENCIA	P.V.P.	Kg.	 
1602913040	CIRCLINE - 40W. H.F.	251,80 €	(3,5)	
1602913042	CIRCLINE - 40+22W. H.F.	267,23 €	(3,5)	
1602913055	CIRCLINE - 55W. H.F.	322,89 €	(3,5)	

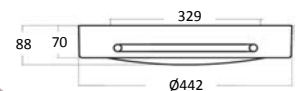

1602923040G	CIRCLINE/GRIS - 40W. H.F.	271,30 €	(3,5)	
1602923042G	CIRCLINE/GRIS - 40+22W. H.F.	286,72 €	(3,5)	
1602923055G	CIRCLINE/GRIS - 55W. H.F.	342,39 €	(3,5)	



Materiales: Cuerpo en policarbonato, difusor de policarbonato prismático.

CODIGO	REFERENCIA	P.V.P.	Kg.	 
1602923040	CIRCLINE PENDULAR - 40W. H.F.	271,21 €	(3,5)	
1602923042	CIRCLINE PENDULAR - 40+22W. H.F.	286,59 €	(3,5)	
1602923055	CIRCLINE PENDULAR - 55W. H.F.	342,26 €	(3,5)	

Suspensiones incluidas.

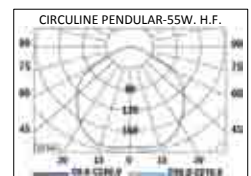

1602923040G	CIRCLINE PENDULAR/GRIS - 40W. H.F.	290,71 €	(3,5)	
1602923042G	CIRCLINE PENDULAR/GRIS - 40+22W. H.F.	306,08 €	(3,5)	
1602923055G	CIRCLINE PENDULAR/GRIS - 55W. H.F.	361,75 €	(3,5)	

Suspensiones incluidas.

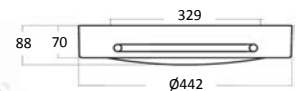

APLIQUES ADOSABLES



Materiales: Cuerpo en policarbonato color blanco, difusor de policarbonato opal, cierres de policarbonato.

CODIGO	REFERENCIA	P.V.P.	Kg.		
160270L150	LUNA LED-350 IP65 16W. 1500lm/840	216,72 €	(1,5)		

Detector de presencia bajo consulta.

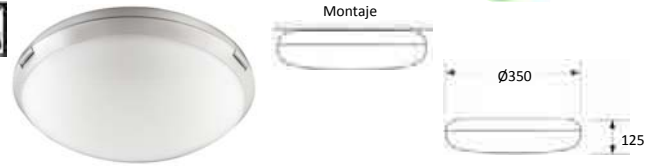

Materiales: Cuerpo en policarbonato color blanco, difusor de PMMA opal.

CODIGO	REFERENCIA	P.V.P.	Kg.		
LASC0L090	SC LED-300 IP65 13W. 900lm/840	359,24 €	(1,8)		

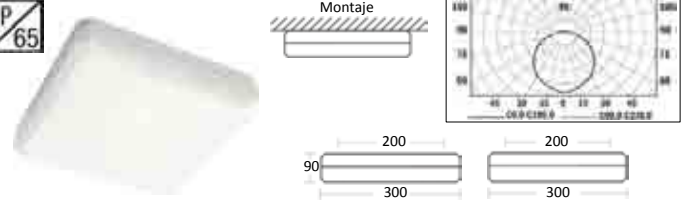

ADOSABLES CIRCULARES OJOS DE BUEY

Materiales: Cuerpo en policarbonato color blanco, difusor de policarbonato opal, cierres de policarbonato.

CODIGO	REFERENCIA	P.V.P.	Kg.		
1602703022L	LUNA-350 IP65 22W. H.F. + Lámpara	111,49 €	(1,4)		

Detector de presencia bajo consulta.

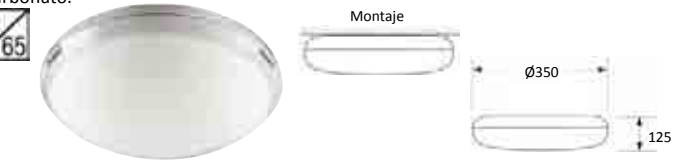





1602713040L	LUNA-430 IP65 40W. H.F. + Lámpara	127,64 €	(2,1)
1602713402L	LUNA-430 IP65 40+22W. H.F. + Lámparas	175,27 €	(2,2)
1602713055L	LUNA-430 IP65 55W. H.F. + Lámpara	154,84 €	(2,1)
1602713552L	LUNA-430 IP65 55+22W. H.F. + Lámparas	220,68 €	(2,2)

Detector de presencia bajo consulta.





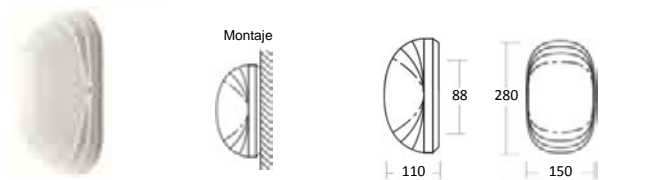

Materiales: Cuerpo en policarbonato irrompible, difusor de policarbonato opalino.

CODIGO	REFERENCIA	P.V.P.	Kg.				
0202204040	A/E27-40W.	30,99 €	(0,8)				
0202205209	A/G23-2x9W. 230V.	43,01 €	(1,1)				



Materiales: Cuerpo en policarbonato irrompible, difusor de policarbonato opalino.

CODIGO	REFERENCIA	P.V.P.	Kg.				
0202204060	AX/E27-40W.	31,67 €	(1,0)				
0202205219	AX/G23-2x9W. 230V.	43,70 €	(1,3)				

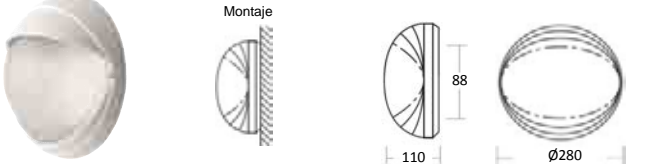



Materiales: Cuerpo en policarbonato irrompible, difusor de policarbonato opalino.

CODIGO	REFERENCIA	P.V.P.	Kg.			
0202206100	CLT-IP44/E27-100W.	20,47 €	(0,8)			

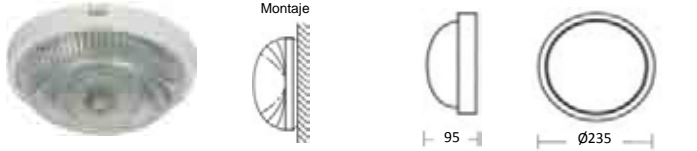
Embalaje 5 unidades.



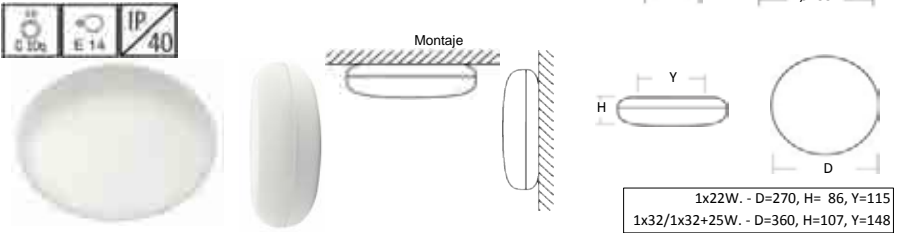

Materiales: Cuerpo en policarbonato, difusor de policarbonato opal.

CODIGO	REFERENCIA	P.V.P.	Kg.			
1602500222	SLO-1x22W. 230V.	36,89 €	(1,6)			
1602500232	SLO-1x32W. 230V.	48,42 €	(2,0)			
1602503225	SLO-1x32W.+25W. 230V.	48,42 €	(2,1)			



1x22W. - D=270, H= 86, Y=115
1x32/1x32+25W. - D=360, H=107, Y=148

Materiales: Cuerpo en policarbonato, difusor de policarbonato prismático.

CODIGO	REFERENCIA	P.V.P.	Kg.			
1602600222	SLP-1x22W. 230V.	38,66 €	(1,6)			
1602600232	SLP-1x32W. 230V.	53,68 €	(2,0)			
1602603225	SLP-1x32W.+25W. 230V.	53,68 €	(2,1)			

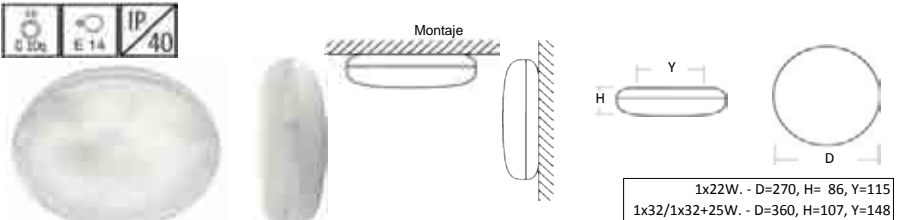

1x22W. - D=270, H= 86, Y=115
1x32/1x32+25W. - D=360, H=107, Y=148

LUMINARIAS DE EMERGENCIA

Materiales: Cuerpo en policarbonato, difusor de policarbonato transparente.

CODIGO	REFERENCIA	P.V.P.	Kg.
0203001000	E-1000 (8W. T5 3h NO PER. IP65)	56,14 €	(1,1)

Pictogramas incluidos.



Montaje

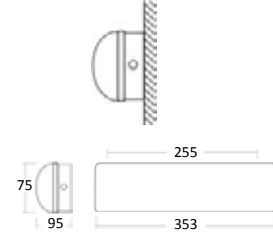

Materiales: Cuerpo en policarbonato, difusor de policarbonato transparente.

CODIGO	REFERENCIA	P.V.P.	Kg.
0203002000	E-2000 (8W. T5 3h NO PER. IP65) (80Lm)	57,70 €	(1,0)

Pictogramas incluidos.



Montaje

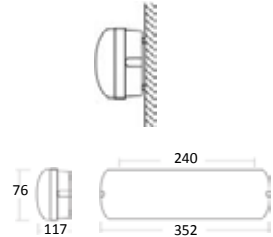

Materiales: Cuerpo en ABS, difusor de policarbonato transparente.

CODIGO	REFERENCIA	P.V.P.	Kg.
0203003000	E-3000 (8W. T5 1,5h NO PER. IP42)	86,18 €	(0,9)
02030030001	CAJA E-3000 EMPOTRAR + MUELLES	34,74 €	---

Pictogramas incluidos.



Montaje

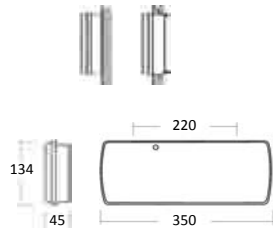

Materiales: Cuerpo en perfil de aluminio, difusor de plexiglass.

CODIGO	REFERENCIA	P.V.P.	Kg.
0203004000	E-4000L (8W. LEDS 3h PER. IP30)	288,73 €	(1,0)

Consumo: 5W.

Rendimiento: 4400 mcd 120°



Montaje

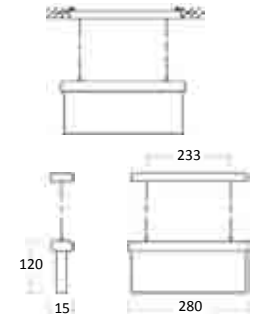

Materiales: Cuerpo en perfil de aluminio, difusor de plexiglass.

CODIGO	REFERENCIA	P.V.P.	Kg.
0203005000	E-5000L (8W. LEDS 3h PER. IP30)	147,60 €	(0,8)

Consumo: 5W.

Rendimiento: 5100 mcd 120°



Montaje

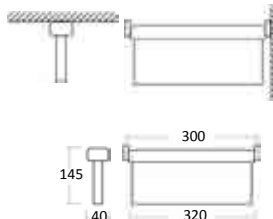

Materiales: Cuerpo en policarbonato, difusor de policarbonato opalizado.

CODIGO	REFERENCIA	P.V.P.	Kg.
0203006000	E-6000 (8W. T5 1h NO PER. IP65) (80Lm)	113,86 €	(1,7)

Pictogramas incluidos.



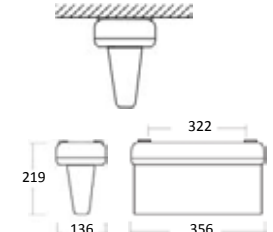

Montaje



ALUMBRADO PUBLICO Y RESIDENCIAL



Materiales: Cuerpo y base en fundición de aluminio esmaldo en color negro RAL 9005, brazos de sujeción de aluminio extruido anodizado en color aluminio.

CODIGO	REFERENCIA	Indice rendimiento de color CRI (Ra)	Temperatura de color CCT (k)	Altura recomendada	Clase de vía	P.V.P.	Kg.		
VOPL417	OPTIMUS LED-4x17W. 5000lm/743	>70	4300	4-6	S2-S3	4.093,74 €	(15,5)		

Entrada **columna** 76mm Ø.

Equipo de control electrónico, doble nivel (100%/50%) EEI=A2.

Amplio rango de temperatura de funcionamiento: -40°C hasta +55°C

Posibilidad de diferentes distribuciones de luz.

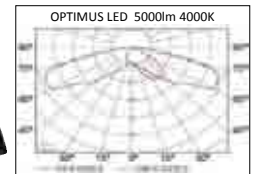

Cantidad mínima 2 unidades.

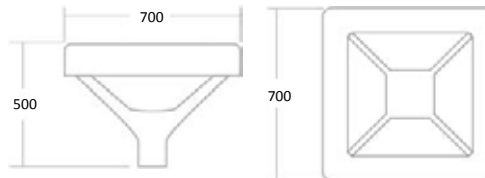
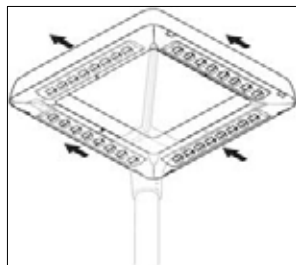
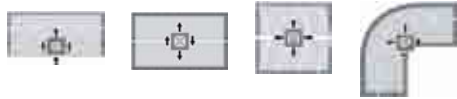

LOR= 85.00%



Materiales: Cuerpo en aluminio extruido RAL 7021, cubierta de luminaria de aluminio fundido RAL 7047 con efecto metálico, difusor PMMA transparente.

CODIGO	REFERENCIA	Indice rendimiento de color CRI (Ra)	Temperatura de color CCT (k)	Altura recomendada	Clase de vía	P.V.P.	Kg.		
1702503217	DENTHIA-M-2x17W. LED 2400lm	>70	4300 ó 5300	6-10	S3	2.126,40 €	(13,5)		
1702503417	DENTHIA-M-4x17W. LED 4800lm	>70	4300 ó 5300	6-10	ME5	2.126,40 €	(13,5)		
1702503617	DENTHIA-M-6x17W. LED 7200lm	>70	4300 ó 5300	8-12	ME4b	2.126,40 €	(13,5)		

Entrada **columna** 76mm Ø.

Equipo de control electrónico, doble nivel (100%/50%) EEI=A2.

Posibilidad de selección de la temperatura de color de la luz, 4300K ó 5300K.

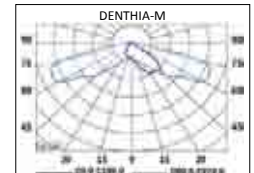

DENTHIA-M

DENTHIA-L

DENTHIA-XL

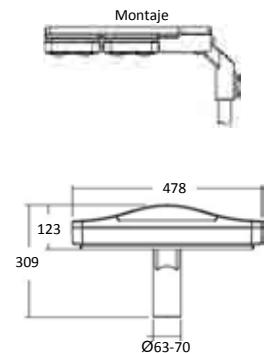
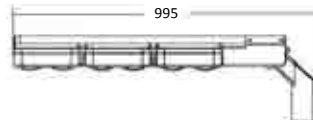
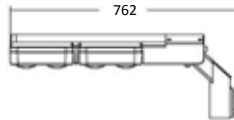
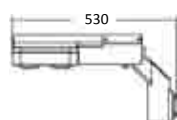

Tira de color: Bajo consulta
Colores disponibles: Rojo, Amarillo, Verde y Azul



Materiales: Cuerpo en aluminio extruido color negro con marco inferior en color gris, difusor PMMA transparente.

CODIGO	REFERENCIA	Indice rendimiento de color CRI (Ra)	Temperatura de color CCT (k)	Altura recomendada	Clase de vía	P.V.P. Kg.
VO4L019	ZEPHYR 1 LED-19W. 1300lm/742	>70	4200	4-5	S4	PENDIENTE DE FABRICACION
VO4L035	ZEPHYR 2 LED-35W. 2700lm/742	>70	4200	6-10	ME5	PENDIENTE DE FABRICACION
VO4L092	ZEPHYR 3 LED-92W. 6600lm/742	>70	4200	8-12	ME4	PENDIENTE DE FABRICACION
VO4L092	ZEPHYR 3 LED-122W. 9300lm/742	>70	4200	8-12	ME3	PENDIENTE DE FABRICACION



Entrada **columna** 60mm Ø.

Amplio rango de temperatura de funcionamiento: -20°C hasta +50°C

Bajo consulta, equipo de control electrónico, doble nivel (100%/50%) EEI=A2.

Bajo consulta, equipo de control electrónico dimmable 1-10V EEI=A1.

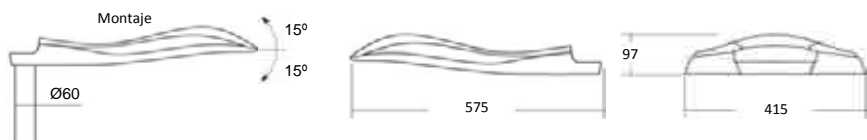
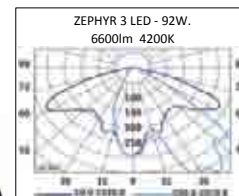

Materiales: Cuerpo en fundición de aluminio color negro y marco y cubierta inferior en policarbonato color gris, reflector aluminio MIRO4.

CODIGO	REFERENCIA	Indice rendimiento de color CRI (Ra)	Temperatura de color CCT (k)	Altura recomendada	Clase de vía	P.V.P. Kg.
VZA0L710	ZAKLA-79W. LED 1-10V 7100lm/750	>70	5000	7-12	ME5	2.045,43 € (12,0)
VZA0L830	ZAKLA-92W. LED 1-10V 8300lm/750	>70	5000	7-12	ME5	2.166,24 € (12,0)
VZA0L950	ZAKLA-106W. LED 1-10V 9500lm/750	>70	5000	7-12	ME4	2.286,46 € (12,0)
VZA0L1070	ZAKLA-120W. LED 1-10V 10700lm/750	>70	5000	7-12	ME4	2.403,55 € (12,0)



Entrada **brazo o columna** 60mm Ø.

Temperatura ambiente desde -35°C hasta 50°C.

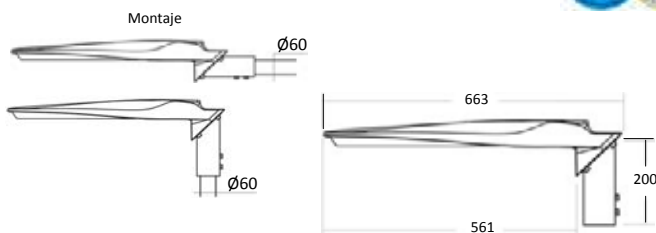
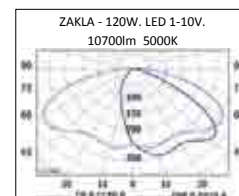

Materiales: Cuerpo en poliéster reforzado con fibra de vidrio RAL 7035, difusor de policarbonato irrompible transparente con prismas longitudinales Fresnel y cierres inox (acero inoxidable).

CODIGO	REFERENCIA	Indice rendimiento de color CRI (Ra)	Temperatura de color CCT (k)	Altura recomendada	Clase de vía	P.V.P. Kg.
070L137	LPX-LED-37W. 3000lm/740	>75	4000	3-8	S4	801,39 € (5,6)



Entrada **brazo** 50mm Ø (estándar) o **columna** 60mm Ø (bajo consulta).

LED **PHILIPS** FORTIMO

Equipo de control electrónico **PHILIPS** XITANIUM dimmable 1-10V EEI=A1.

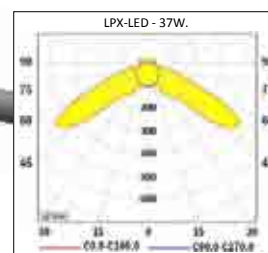

LOR=93%

Materiales: Cuerpo en aluminio fundido moldeado por inyección color aluminio, difusor de policarbonato irrompible transparente con prismas longitudinales Fresnel y cierres inox (acero inoxidable).

CODIGO	REFERENCIA	Indice rendimiento de color CRI (Ra)	Temperatura de color CCT (k)	Altura recomendada	Clase de vía	P.V.P. Kg.
071L155	LPX/AL-LED-55W. 4500lm/740	>75	4000	3-8	S4	801,39 € (5,6)



Entrada **brazo** 50mm Ø (estándar) o **columna** 60mm Ø (bajo consulta).



LED **PHILIPS** FORTIMO

Equipo de control electrónico **PHILIPS** XITANIUM dimmable 1-10V EEI=A1.



ALUMBRADO RESIDENCIAL T-5

Materiales: Cuerpo en aluminio extruido y cabezal de fundición de aluminio, esmaltado en color gris oscuro de alta resistencia a la corrosión, difusor de policarbonato resistente al calor y a los impactos.

CODIGO	REFERENCIA			P.V.P.	Kg.		
1702603328	VELTA-3x28W. H.F.	T5	G5	890,18 €	(9,0)		

Balasto electrónico EI1=A2.

Balasto electrónico regulable EE1=A1 , bajo consulta.

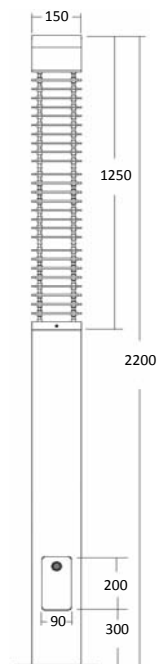
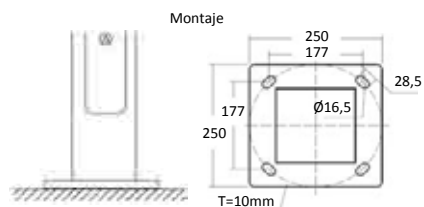

ALUMBRADO PUBLICO DESCARGA LAMPARAS COMPACTAS

Materiales: Cuerpo en aluminio inyectado (RAL-9006), reflector aluminio, difusor cristal templado,cierres inox.

CODIGO	REFERENCIA			P.V.P.	Kg.
0701101050	ANDROMEDA 1- 50W.	V.M.	E-27	144,22 €	(7,3)
0701101080	ANDROMEDA 1- 80W.	V.M.	E-27	150,08 €	(7,3)
0701101125	ANDROMEDA 1- 125W.	V.M.	E-27	146,66 €	(7,3)
0701102070	ANDROMEDA 1- 70W.	HPS	E-27	171,01 €	(7,3)
0701103070	ANDROMEDA 1- 70W.	HIT	E-27	171,01 €	(7,3)
0701202070	ANDROMEDA 2- 70W.	HPS	E-27	214,70 €	(8,3)
0701202100	ANDROMEDA 2- 100W.	HPS	E-40	221,56 €	(8,8)
0701202150	ANDROMEDA 2- 150W.	HPS	E-40	232,11 €	(9,2)
0701203070	ANDROMEDA 2- 70W.	HIT	E-27	214,70 €	(8,3)
0701203100	ANDROMEDA 2- 100W.	HIT	E-40	221,56 €	(8,8)
0701203150	ANDROMEDA 2- 150W.	HIT	E-40	232,11 €	(9,2)
0701301250	ANDROMEDA 3- 250W.	V.M.	E-40	254,92 €	(9,8)
0701302250	ANDROMEDA 3- 250W.	HPS	E-40	287,82 €	(10,9)
0701303250	ANDROMEDA 3- 250W.	HIT	E-40	287,82 €	(10,9)

0701402400	ANDROMEDA 4- 400W.	HPS	E-40	367,13 €	(13,5)
0701403400	ANDROMEDA 4- 400W.	HIT	E-40	367,13 €	(13,5)

Entrada **brazo o columna** 60mm Ø.

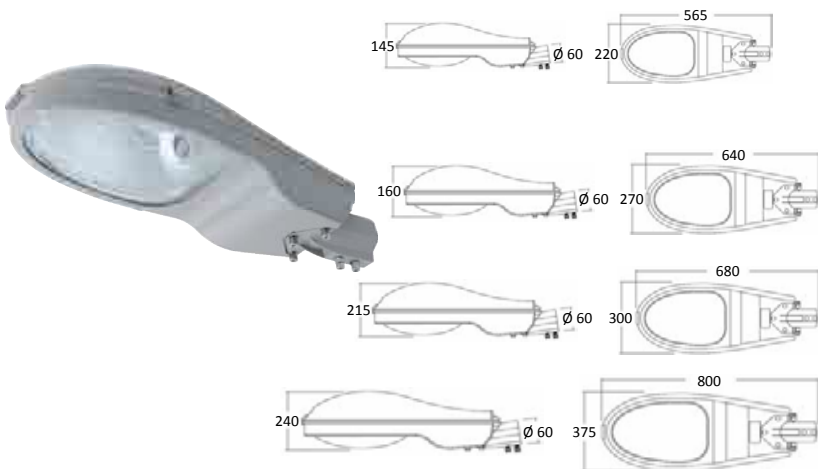
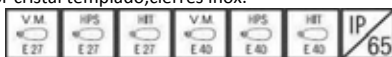

Materiales: Cuerpo en aluminio inyectado (RAL-7035), reflector aluminio, difusor cristal templado,cierres inox.

CODIGO	REFERENCIA			P.V.P.	Kg.
0703012070	FORNAX-70W.	HPS	E-27	191,77 €	(6,7)
0703012100	FORNAX-100W.	HPS	E-40	196,26 €	(6,7)
0703012150	FORNAX-150W.	HPS	E-40	213,81 €	(7,4)
0703013100	FORNAX-100W.	HIT	E-40	196,26 €	(6,7)
0703013150	FORNAX-150W.	HIT	E-40	213,81 €	(7,4)
07030120701	FORNAX-D/E-70W.	* HPS	E-27	203,08 €	(7,1)
07030121001	FORNAX-D/E-100W.	* HPS	E-40	208,84 €	(7,1)
07030121501	FORNAX-D/E-150W.	* HPS	E-40	226,39 €	(7,7)
07030131001	FORNAX-D/E-100W.	* HIT	E-40	208,84 €	(7,1)
07030131501	FORNAX-D/E-150W.	* HIT	E-40	226,39 €	(7,7)

* FORNAX-D/E, con desconexión eléctrica automática de red en apertura de luminaria.

Entrada **brazo o columna** 60mm Ø.

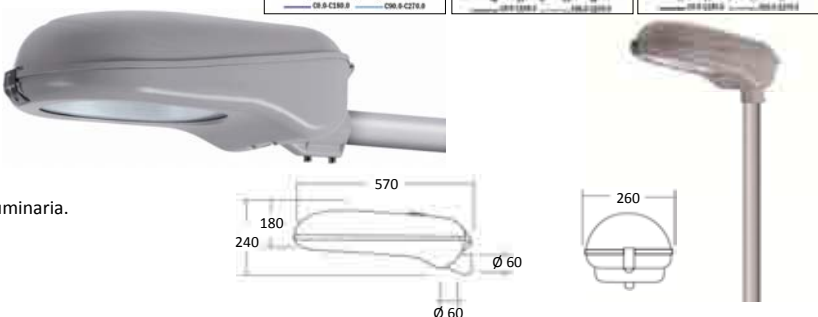
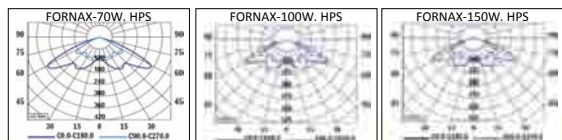

Materiales: Cuerpo en aluminio inyectado (RAL-9006), reflector facetado, difusor policarbonato irrompible,cierres inox.

CODIGO	REFERENCIA			P.V.P.	Kg.
070291070	ALCOTAN-70W.	HPS	E-27	243,82 €	(4,6)
070291100	ALCOTAN-100W.	HPS	E-40	246,12 €	(6,1)
070291150	ALCOTAN-150W.	HPS	E-40	262,02 €	(6,6)
070292070	ALCOTAN-70W.	HIT	E-27	243,82 €	(4,6)
070292100	ALCOTAN-100W.	HIT	E-27	246,12 €	(6,1)
070292150	ALCOTAN-150W.	HIT	E-27	262,02 €	(6,6)

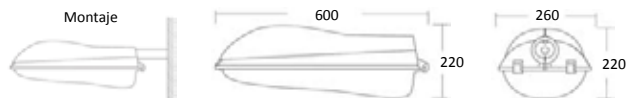

Materiales: Cuerpo en poliéster reforzado con fibra de vidrio (RAL-7035), difusor policarbonato irrompible,cierres inox.

CODIGO	REFERENCIA			P.V.P.	Kg.
070247	LPX-35W. L.P.S. (SODIO BAJA)			238,44 €	(5,6)
070248	LPX-55W. L.P.S. (SODIO BAJA)			257,16 €	(5,6)
070243	LPX-2x36W. TC-L 230V. A.F.			203,99 €	(6,1)
0702436	LPX-2x36W. TC-L H.F.			211,84 €	(5,0)

Entrada **brazo** 50mm Ø (estándar).

Entrada **columna** 60mm Ø (bajo consulta).



ESFERICAS DESCARGA

BOLAS ANTI-POLUCION LUMINICA POLICARBONATO PRISMATICO (LPP-I/APL)

REFERENCIA	BASE ALUMINIO CON CUBRE-EQUIPOS Y REFLECTOR LAMINAR		BASE ALUMINIO CON CUBRE-EQUIPOS		DIFUSOR
	P.V.P.	Kg.	P.V.P.	Kg.	P.V.P.
LPP-I/APL/GRIS-500 (VM-80W.)	384,43 €	(2,5)	318,27 €	(2,5)	207,37 € 1702106500
LPP-I/APL/GRIS-500 (VM-125W.)	386,72 €	(3,0)	320,56 €	(3,0)	207,37 € 1702106500
LPP-I/APL/GRIS-500 (HPS-70W.)	396,59 €	(2,6)	330,43 €	(2,6)	207,37 € 1702106500
LPP-I/APL/GRIS-500 (HPS-100W.)	406,35 €	(2,7)	340,19 €	(2,7)	207,37 € 1702106500
LPP-I/APL/GRIS-500 (HPS-150W.)	414,16 €	(4,0)	348,00 €	(4,0)	207,37 € 1702106500

Semiesfera en color gris (estándar), en color negro bajo consulta.
Entrada columna de Ø 60 ó 50 mm.



BOLAS DE POLICARBONATO OPAL (LPO)

REFERENCIA	BASE ALUMINIO		BASE POLICARBONATO		DIFUSOR
	P.V.P.	Kg.	P.V.P.	Kg.	P.V.P.
LPO-400 (VM-80W.)	145,71 €	(2,5)	130,72 €	(2,1)	64,23 € 1702001400
LPO-400 (VM-125W.)	148,00 €	(3,0)	133,01 €	(2,6)	64,23 € 1702001400
LPO-400 (HPS-70W.)	157,87 €	(2,6)	142,88 €	(2,2)	64,23 € 1702001400
LPO-450 (VM-80W.)	156,32 €	(2,5)	141,33 €	(2,1)	74,84 € 1702001450
LPO-450 (VM-125W.)	158,61 €	(3,0)	143,62 €	(2,6)	74,84 € 1702001450
LPO-450 (HPS-70W.)	168,48 €	(2,6)	153,49 €	(2,2)	74,84 € 1702001450
LPO-450 (HPS-100W.)	178,24 €	(2,7)	163,40 €	(2,3)	74,84 € 1702001450
LPO-450 (HPS-150W.)	186,05 €	(4,0)	171,21 €	(3,6)	74,84 € 1702001450
LPO-500 (VM-80W.)	178,80 €	(2,5)	163,81 €	(2,1)	97,32 € 1702001500
LPO-500 (VM-125W.)	181,09 €	(3,0)	166,10 €	(2,6)	97,32 € 1702001500
LPO-500 (HPS-70W.)	190,96 €	(2,6)	175,97 €	(2,2)	97,32 € 1702001500
LPO-500 (HPS-100W.)	200,72 €	(2,7)	185,88 €	(2,3)	97,32 € 1702001500
LPO-500 (HPS-150W.)	208,53 €	(4,0)	193,69 €	(3,6)	97,32 € 1702001500
LPO-550 (VM-125W.)	203,63 €	(3,0)	188,64 €	(2,6)	119,86 € 1702001550
LPO-550 (VM-250W.)	224,13 €	(3,9)	209,29 €	(3,5)	119,86 € 1702001550
LPO-550 (HPS-70W.)	213,50 €	(2,6)	198,51 €	(2,2)	119,86 € 1702001550
LPO-550 (HPS-100W.)	223,26 €	(2,7)	208,42 €	(2,3)	119,86 € 1702001550
LPO-550 (HPS-150W.)	231,07 €	(4,0)	216,23 €	(3,6)	119,86 € 1702001550

Entrada columna de Ø 60 ó 50 mm.



BOLAS DE POLICARBONATO

LPI (INCOLORO)

LPF (FUME INCOLORO)

REFERENCIA	BASE ALUMINIO CON CUBRE-EQUIPOS Y REFLECTOR LAMINAR		BASE ALUMINIO CON CUBRE-EQUIPOS		DIFUSOR
	P.V.P.	Kg.	P.V.P.	Kg.	P.V.P.
LPI/LPF-400 (VM-80W.)	241,29 €	(2,5)	175,13 €	(2,1)	64,23 € 1702002400 / 3400
LPI/LPF-400 (VM-125W.)	243,58 €	(3,0)	177,42 €	(2,6)	64,23 € 1702002400 / 3400
LPI/LPF-400 (HPS-70W.)	253,45 €	(2,6)	187,29 €	(2,2)	64,23 € 1702002400 / 3400
LPI/LPF-450 (VM-80W.)	251,90 €	(2,5)	185,74 €	(2,1)	74,84 € 1702002450 / 3450
LPI/LPF-450 (VM-125W.)	254,19 €	(3,0)	188,03 €	(2,6)	74,84 € 1702002450 / 3450
LPI/LPF-450 (HPS-70W.)	264,06 €	(2,6)	197,90 €	(2,2)	74,84 € 1702002450 / 3450
LPI/LPF-450 (HPS-100W.)	273,82 €	(2,7)	207,66 €	(2,3)	74,84 € 1702002450 / 3450
LPI/LPF-450 (HPS-150W.)	281,63 €	(4,0)	215,47 €	(3,6)	74,84 € 1702002450 / 3450
LPI/LPF-500 (VM-80W.)	274,38 €	(2,5)	208,22 €	(2,1)	97,32 € 1702002500 / 3500

CONTINUA EN LA PAGINA SIGUIENTE



ESFERICAS DESCARGA

BOLAS DE POLICARBONATO

LPI (INCOLORO)

LPF (FUME INCOLORO)

REFERENCIA	BASE ALUMINIO CON CUBRE-EQUIPOS Y REFLECTOR LAMINAR		BASE ALUMINIO CON CUBRE-EQUIPOS		DIFUSOR P.V.P.
	P.V.P.	Kg.	P.V.P.	Kg.	
LPI/LPF-500 (VM-125W.)	276,67 €	(3,0)	210,51 €	(2,6)	97,32 € 1702002500 / 3500
LPI/LPF-500 (HPS-70W.)	286,54 €	(2,6)	220,38 €	(2,2)	97,32 € 1702002500 / 3500
LPI/LPF-500 (HPS-100W.)	296,30 €	(2,7)	230,14 €	(2,3)	97,32 € 1702002500 / 3500
LPI/LPF-500 (HPS-150W.)	304,11 €	(4,0)	237,95 €	(3,6)	97,32 € 1702002500 / 3500
LPI/LPF-550 (VM-125W.)	299,21 €	(3,0)	233,05 €	(2,6)	119,86 € 1702002550 / 3550
LPI/LPF-550 (VM-250W.)	319,71 €	(3,9)	253,55 €	(3,5)	119,86 € 1702002550 / 3550
LPI/LPF-550 (HPS-70W.)	309,08 €	(2,6)	242,92 €	(2,2)	119,86 € 1702002550 / 3550
LPI/LPF-550 (HPS-100W.)	318,84 €	(2,7)	252,68 €	(2,3)	119,86 € 1702002550 / 3550
LPI/LPF-550 (HPS-150W.)	326,65 €	(4,0)	260,49 €	(3,6)	119,86 € 1702002550 / 3550

Entrada columna de Ø 60 ó 50 mm.



BOLAS DE POLIETILENO OPAL (LEO)

REFERENCIA	BASE ALUMINIO		BASE POLICARBONATO		DIFUSOR P.V.P.
	P.V.P.	Kg.	P.V.P.	Kg.	
LEO-400 (VM-80W.)	118,30 €	(2,5)	103,31 €	(2,1)	36,82 € 1702000400
LEO-400 (VM-125W.)	120,59 €	(3,0)	105,60 €	(2,6)	36,82 € 1702000400
LEO-400 (HPS-70W.)	130,46 €	(2,6)	115,47 €	(2,2)	36,82 € 1702000400
LEO-450 (VM-80W.)	124,10 €	(2,5)	109,11 €	(2,1)	42,62 € 1702000450
LEO-450 (VM-125W.)	126,39 €	(3,0)	111,40 €	(2,6)	42,62 € 1702000450
LEO-450 (HPS-70W.)	136,26 €	(2,6)	121,27 €	(2,2)	42,62 € 1702000450
LEO-450 (HPS-100W.)	146,02 €	(2,7)	131,18 €	(2,3)	42,62 € 1702000450
LEO-450 (HPS-150W.)	153,83 €	(4,0)	138,99 €	(3,6)	42,62 € 1702000450
LEO-500 (VM-80W.)	142,51 €	(2,5)	127,52 €	(2,1)	61,03 € 1702000500
LEO-500 (VM-125W.)	144,80 €	(3,0)	129,81 €	(2,6)	61,03 € 1702000500
LEO-500 (HPS-70W.)	154,67 €	(2,6)	139,68 €	(2,2)	61,03 € 1702000500
LEO-500 (HPS-100W.)	164,43 €	(2,7)	149,59 €	(2,3)	61,03 € 1702000500
LEO-500 (HPS-150W.)	172,24 €	(4,0)	157,40 €	(3,6)	61,03 € 1702000500
LEO-550 (VM-125W.)	154,01 €	(3,0)	139,02 €	(2,6)	70,24 € 1702000550
LEO-550 (VM-250W.)	174,51 €	(3,9)	159,67 €	(3,5)	70,24 € 1702000550
LEO-550 (HPS-70W.)	163,88 €	(2,6)	148,89 €	(2,2)	70,24 € 1702000550
LEO-550 (HPS-100W.)	173,64 €	(2,7)	158,80 €	(2,3)	70,24 € 1702000550
LEO-550 (HPS-150W.)	181,45 €	(4,0)	166,61 €	(3,6)	70,24 € 1702000550

Entrada columna de Ø 60 ó 50 mm.



DESGLOSE LUMINARIAS ESFERICAS

CODIGO	REFERENCIA	P.V.P.
1712000080	EQUIPO ELECTRICO (80W.) V.M.	33,19 €
1712000125	EQUIPO ELECTRICO (125W.) V.M.	35,48 €
1712000250	EQUIPO ELECTRICO (250W.) V.M.	48,86 €
1712000070	EQUIPO ELECTRICO (70W.) H.P.S.	45,35 €
1712000100	EQUIPO ELECTRICO (100W.) H.P.S.	47,99 €
1712000150	EQUIPO ELECTRICO (150W.) H.P.S.	55,80 €
1792000027	BASE ALUMINIO - E27	48,29 €
1792000040	BASE ALUMINIO - E40	55,41 €
1792000227	BASE POLICARBONATO - E27	33,30 €
1792000240	BASE POLICARBONATO - E40	40,57 €
1792200027	BASE ALUMINIO - E27 + CUBRE-EQUIPOS	77,71 €
1792200040	BASE ALUMINIO - E40 + CUBRE-EQUIPOS	84,83 €
1792001001	CUBRE-EQUIPOS	22,08 €
1792300027	BASE ALUMINIO - E27 + CUBRE-EQUIPOS + REFLECTOR LAMINAR	143,87 €
1792300040	BASE ALUMINIO - E40 + CUBRE-EQUIPOS + REFLECTOR LAMINAR	150,99 €



PROYECTOR ATHENA 1000W - 2000W DESCARGA



ATHENA

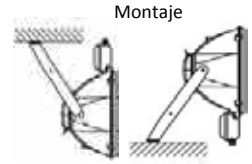
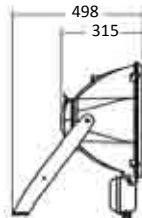
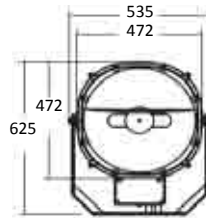

Montaje

Optica C6 Fotometrias

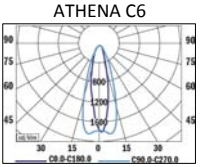
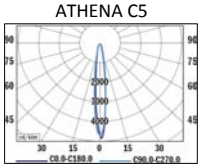
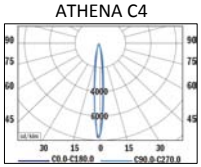
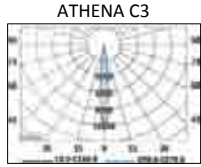
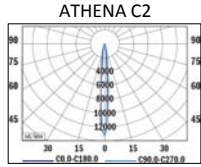
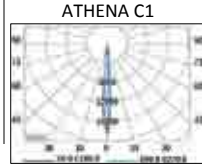

ATHENA BOOSTER

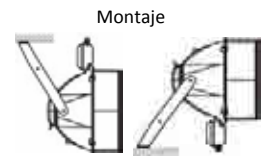
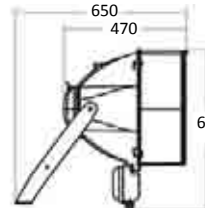
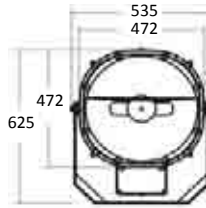

Montaje

Optica C6 Fotometrias

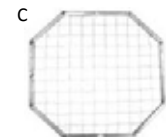
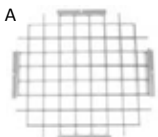
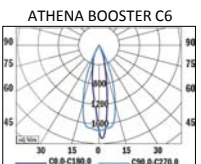
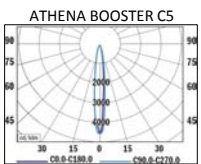
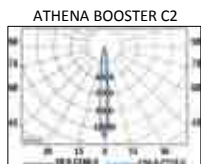
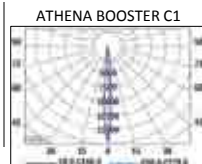

CODIGO	REFERENCIA	OPTICA	P.V.P.	Kg.	Potencia	Lámpara	Portalámparas	Superficie Max. expuesta al viento	Color
W									
0631113100	ATHENA C1 1000W.	C1 - Circular/ultra intensiva	1.282,01 €	(15,5)	1X1000	MN	cabla	0,20	RAL 9006
0631123100	ATHENA C2 1000W.	C2 - Circular/intensiva	1.441,60 €	(15,5)	1X1000	MN	cabla	0,20	RAL 9006
0631133100	ATHENA C3 1000W.	C3 - Circular/media	1.441,60 €	(15,5)	1X1000	MN	cabla	0,20	RAL 9006
0631143100	ATHENA C4 1000W.	C4 - Circular/semiextensiva	1.441,60 €	(15,5)	1X1000	MN	cabla	0,20	RAL 9006
0631153100	ATHENA C5 1000W.	C5 - Circular/extensiva	1.441,60 €	(15,5)	1X1000	MN	cabla	0,20	RAL 9006
0631163100	ATHENA C6 1000W.	C6 - Circular/ultra extensiva	1.441,60 €	(15,5)	1X1000	MN	cabla	0,20	RAL 9006
0631113200	ATHENA C1 2000W.	C1 - Circular/ultra intensiva	1.282,01 €	(15,5)	1X2000	MN	cabla	0,20	RAL 9006
0631123200	ATHENA C2 2000W.	C2 - Circular/intensiva	1.441,60 €	(15,5)	1X2000	MN	cabla	0,20	RAL 9006
0631133200	ATHENA C3 2000W.	C3 - Circular/media	1.441,60 €	(15,5)	1X2000	MN	cabla	0,20	RAL 9006
0631143200	ATHENA C4 2000W.	C4 - Circular/semiextensiva	1.441,60 €	(15,5)	1X2000	MN	cabla	0,20	RAL 9006
0631153200	ATHENA C5 2000W.	C5 - Circular/extensiva	1.441,60 €	(15,5)	1X2000	MN	cabla	0,20	RAL 9006
0631163200	ATHENA C6 2000W.	C6 - Circular/ultra extensiva	1.441,60 €	(15,5)	1X2000	MN	cabla	0,20	RAL 9006
0631213100	ATHENA BOOSTER C1 1000W.	C1 - Circular/ultra intensiva	2.367,04 €	(19,2)	1X1000	MN	cabla	0,20	RAL 9006
0631223100	ATHENA BOOSTER C2 1000W.	C2 - Circular/intensiva	2.193,98 €	(19,2)	1X1000	MN	cabla	0,20	RAL 9006
0631233100	ATHENA BOOSTER C3 1000W.	C3 - Circular/media	2.193,98 €	(19,2)	1X1000	MN	cabla	0,20	RAL 9006
0631243100	ATHENA BOOSTER C4 1000W.	C4 - Circular/semiextensiva	2.193,98 €	(19,2)	1X1000	MN	cabla	0,20	RAL 9006
0631253100	ATHENA BOOSTER C5 1000W.	C5 - Circular/extensiva	2.193,98 €	(19,2)	1X1000	MN	cabla	0,20	RAL 9006
0631263100	ATHENA BOOSTER C6 1000W.	C6 - Circular/ultra extensiva	2.193,98 €	(19,2)	1X1000	MN	cabla	0,20	RAL 9006
0631213200	ATHENA BOOSTER C1 2000W.	C1 - Circular/ultra intensiva	2.367,04 €	(19,2)	1X2000	MN	cabla	0,20	RAL 9006
0631223200	ATHENA BOOSTER C2 2000W.	C2 - Circular/intensiva	2.193,98 €	(19,2)	1X2000	MN	cabla	0,20	RAL 9006
0631233200	ATHENA BOOSTER C3 2000W.	C3 - Circular/media	2.193,98 €	(19,2)	1X2000	MN	cabla	0,20	RAL 9006
0631243200	ATHENA BOOSTER C4 2000W.	C4 - Circular/semiextensiva	2.193,98 €	(19,2)	1X2000	MN	cabla	0,20	RAL 9006
0631253200	ATHENA BOOSTER C5 2000W.	C5 - Circular/extensiva	2.193,98 €	(19,2)	1X2000	MN	cabla	0,20	RAL 9006
0631263200	ATHENA BOOSTER C6 2000W.	C6 - Circular/ultra extensiva	2.193,98 €	(19,2)	1X2000	MN	cabla	0,20	RAL 9006
0631100001	(A) REJILLA DE PROTECCION ATHENA		243,72 €	---	---	---	---	---	---
0631100002	(B) BISERA CIRCULAR ATHENA		462,61 €	---	---	---	---	---	---
0631100003	(C) REJILLA DE PROTECCIÓN ACERO INOXIDABLE ATHENA		144,56 €	---	---	---	---	---	---
0631100004	(D) BOOSTER CIRCULAR NEGRO (solo ATHENA BOOSTER)		383,94 €	---	---	---	---	---	---
200210005	LAMPARA OSRAM HQI-TS 1000W/D/S K12S		476,26 €	---	1000	MN	cabla	Arco corto 9,4A 5900k	
06025110005	EQUIPO ELECTRICO 1000W. COFRE ALUMINIO IP 65		420,20 €	---	1000	---	---	1000.3/E, 10,3A	
06025110006	EQUIPO ELECTRICO 1000W. COFRE PLASTICO IP 66		371,73 €	---	1000	---	---	1000.3/E, 10,3A CLASE II	
200220006	LAMPARA OSRAM HQI-TS 2000W/NDL/S K12S		459,19 €	---	2000	MN	cabla	Arco corto 11,3A 4400k	
200220005	LAMPARA OSRAM HQI-TS 2000W/D/S K12S		504,68 €	---	2000	MN	cabla	Arco corto 11,5A 5900k	
06025120005	EQUIPO ELECTRICO 2000W. COFRE ALUMINIO IP 65		524,30 €	---	2000	---	---	2400.34, 10,3A/11,3A, 380/400V	

PROYECTOR ARCOS 1000W DESCARGA

ARCOS/SIMETRICO



ARCOS/ASIMETRICO



ARCOS/CIRCULAR

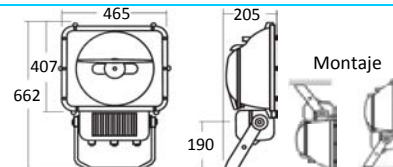
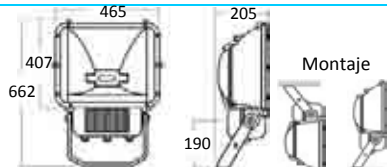
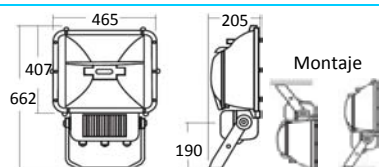

Fotometrias

ARCOS/SIMETRICO L2
MN - ARCO LARGO



ARCOS/SIMETRICO P4
MN - ARCO LARGO

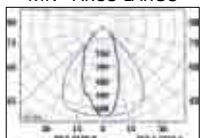

ARCOS/SIMETRICO L2
MN - ARCO CORTO



ARCOS/SIMETRICO P4
MN - ARCO CORTO



ARCOS/ASIMETRICO L2
MN - ARCO LARGO

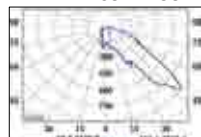

ARCOS/ASIMETRICO L4
MN - ARCO LARGO



ARCOS/ASIMETRICO L2
MN - ARCO CORTO

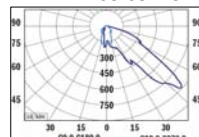

ARCOS/ASIMETRICO L4
MN - ARCO CORTO



ARCOS/CIRCULAR C1
MN - ARCO CORTO



ARCOS/CIRCULAR C2
MN - ARCO CORTO



ARCOS/CIRCULAR C3
MN - ARCO CORTO



ARCOS/CIRCULAR C4
MN - ARCO CORTO

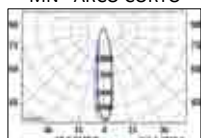

ARCOS/CIRCULAR C5
MN - ARCO CORTO



CODIGO	REFERENCIA	OPTICA	P.V.P.	Kg.	Potencia	Lámpara	Portalámparas	Superficie Max. expuesta al viento	Color	
					W					
						(m ²)				
06313231001	ARCOS/SIMETRICO L2 1000W.	L2 - Lisa/intensiva	787,25 €	(13,5)	1X1000	HIT/HPS	E40	0,26	RAL 9006	
06313431001	ARCOS/SIMETRICO P4 1000W.	P4 - Perlada/semiextensiva	787,25 €	(13,5)	1X1000	HIT/HPS	E40	0,26	RAL 9006	
0631323100	ARCOS/SIMETRICO L2 1000W.	L2 - Lisa/intensiva	1.242,11 €	(13,3)	1X1000	MN	cable	0,26	RAL 9006	
0631343100	ARCOS/SIMETRICO P4 1000W.	P4 - Perlada/semiextensiva	1.242,11 €	(13,3)	1X1000	MN	cable	0,26	RAL 9006	
06313231001A	ARCOS/ASIMETRICO L2 1000W.	L2 - Lisa/intensiva	787,25 €	(13,5)	1X1000	HIT/HPS	E40	0,26	RAL 9006	
0631323100A	ARCOS/ASIMETRICO L2+D 1000W.	L2 - Lisa+deflector/intensiva	1.282,01 €	(13,3)	1X1000	MN	cable	0,26	RAL 9006	
0631343100A	ARCOS/ASIMETRICO L4 1000W.	L4 - Lisa/semiextensiva	1.282,01 €	(13,3)	1X1000	MN	cable	0,26	RAL 9006	
0631413100	ARCOS/CIRCULAR C1 1000W.	C1 - Circular/ultra intensiva	1.441,60 €	(13,3)	1X1000	MN	cable	0,26	RAL 9006	
0631423100	ARCOS/CIRCULAR C2 1000W.	C2 - Circular/intensiva	1.297,95 €	(13,3)	1X1000	MN	cable	0,26	RAL 9006	
0631433100	ARCOS/CIRCULAR C3 1000W.	C3 - Circular/media	1.760,78 €	(13,3)	1X1000	MN	cable	0,26	RAL 9006	
0631443100	ARCOS/CIRCULAR C4 1000W.	C4 - Circular/semiextensiva	1.297,95 €	(13,3)	1X1000	MN	cable	0,26	RAL 9006	
0631453100	ARCOS/CIRCULAR C5 1000W.	C5 - Circular/extensiva	1.297,95 €	(13,3)	1X1000	MN	cable	0,26	RAL 9006	
0631463100	ARCOS/CIRCULAR C6 1000W.	C6 - Circular/ultra extensiva	926,31 €	(13,5)	1X1000	HIT/HPS	E40	0,26	RAL 9006	
0631300101	(A) REJILLA DE PROTECCION ARCOS 1000		110,31 €	---	---	---	---	---	---	
0631300102	(B) REJILLA DE PROTECCIÓN ACERO INOXIDABLE ARCOS 1000W		291,63 €	---	---	---	---	---	---	
0631300103	(C) BISERA CIRCULAR ARCOS 1000W		346,34 €	---	---	---	---	---	---	
0631300104	(D) ACCESORIO ANTIDESLUMBRANTE ARCOS/SIMETRICO 1000W		113,76 €	---	---	---	---	---	---	
0631300105	(E) ACCESORIO ANTIDESLUMBRANTE ARCOS/ASIMETRICO 1000W		264,25 €	---	---	---	---	---	---	
2002210002	LAMPARA PHILIPS HPI-T		197,19 €	---	1000	HIT	E40	8,23A 4300K		
200221000	LAMPARA PHILIPS SON-T		148,98 €	---	1000	HPS	E40	10,60A 2000K		
200210005	LAMPARA OSRAM HQI-TS 1000W/D/S K12S		476,26 €	---	1000	MN	cable	Arco corto K12S 9,4A 5900k		
0602511000	EQUIPO ELECTRICO 1000W. COFRE ALUMINIO IP65 HIT para lámpara Philips		377,88 €	---	1000	---	---	VHE-1000/23 8,25A		
0602521000	EQUIPO ELECTRICO 1000W. COFRE ALUMINIO IP65 HPS para lámpara Philips		387,41 €	---	1000	---	---	VSE-1000/23 10,30A		
06025110006	EQUIPO ELECTRICO 1000W. COFRE ALUMINIO IP65		420,20 €	---	1000	Sin arrancador		1000.3/E, 10,3A		
06025110006	EQUIPO ELECTRICO 1000W. COFRE PLASTICO IP66 CLASE II		371,73 €	---	1000	Sin arrancador		1000.3/E, 10,3A CLASE II		

PROYECTOR ARCOS 2000W DESCARGA

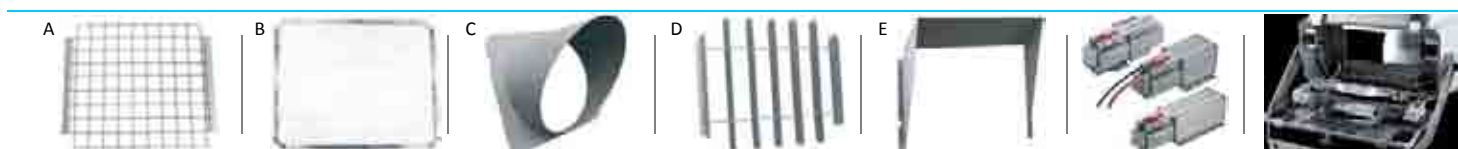
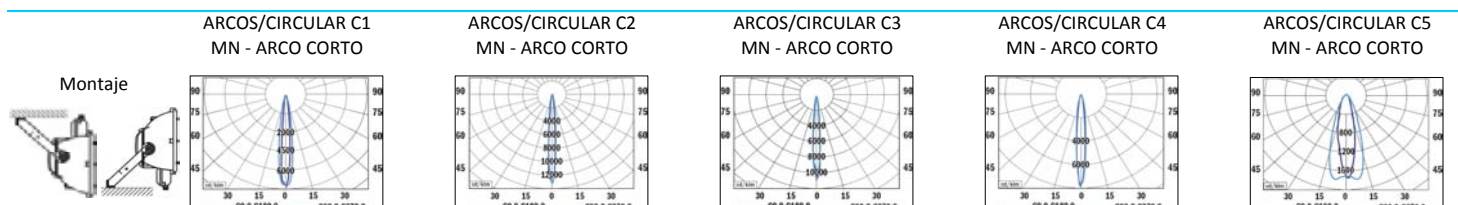
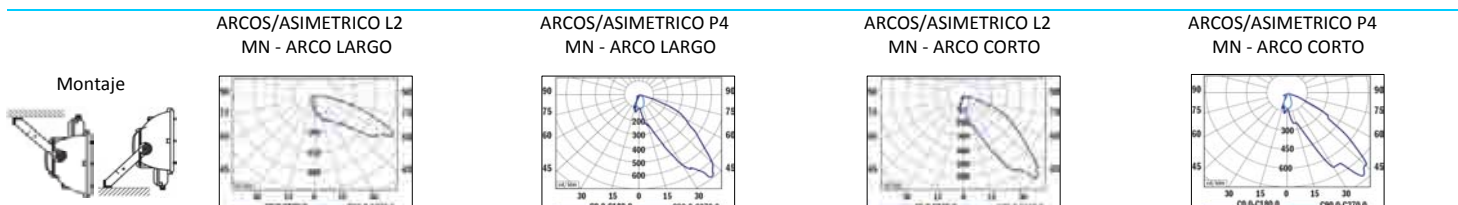
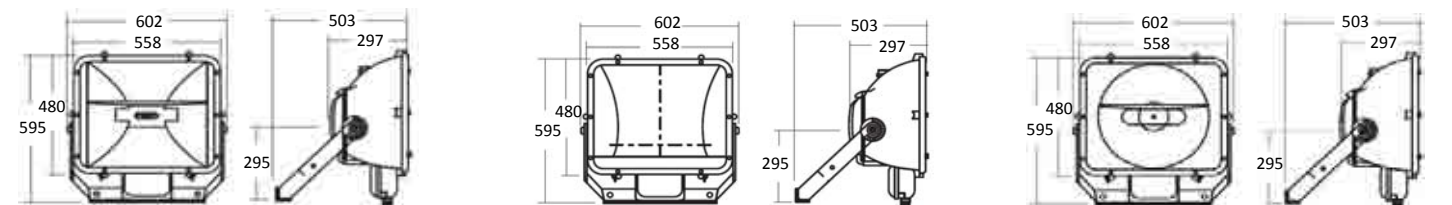

CODIGO	REFERENCIA	OPTICA	P.V.P.	Kg.	Potencia	Lámpara	Portalámparas	Superficie Max. expuesta al viento	Color
					W			(m ²)	
0631323200	ARCOS/SIMETRICO L2 2000W. HIT	L2 - Lisa/intensiva	1.282,01 € (19,4)		1X2000	MN	cable - arco corto/largo	0,26	RAL 9006
0631343200	ARCOS/SIMETRICO P4 2000W. HIT	P4 - Perlada/semiextensiva	1.282,01 € (19,4)		1X2000	MN	cable - arco corto/largo	0,26	RAL 9006
0631323200A	ARCOS/ASIMETRICO L2 2000W. HIT	L2 - Lisa/intensiva	1.282,01 € (19,4)		1X2000	MN	cable - arco corto/largo	0,26	RAL 9006
06313232001A	ARCOS/ASIMETRICO L2+D 2000W. HIT	L2 - Lisa+deflector/intensiva	1.282,01 € (19,4)		1X2000	MN	cable - arco corto/largo	0,26	RAL 9006
0631343200A	ARCOS/ASIMETRICO P4 2000W. HIT	P4 - Perlada/semiextensiva	1.282,01 € (19,4)		1X2000	MN	cable - arco corto	0,26	RAL 9006
06313432001A	ARCOS/ASIMETRICO P4+D 2000W. HIT	P4 - Perlada+deflec/semiextensiva	1.282,01 € (19,4)		1X2000	MN	cable - arco largo	0,26	RAL 9006
0631413200	ARCOS/CIRCULAR C1 2000W. HIT	C1 - Circular/ultra intensiva	1.409,67 € (19,4)		1X2000	MN	cable - arco corto/largo	0,26	RAL 9006
0631423200	ARCOS/CIRCULAR C2 2000W. HIT	C2 - Circular/intensiva	1.409,67 € (19,4)		1X2000	MN	cable - arco corto/largo	0,26	RAL 9006
0631433200	ARCOS/CIRCULAR C3 2000W. HIT	C3 - Circular/media	1.409,67 € (19,4)		1X2000	MN	cable - arco corto	0,26	RAL 9006
0631443200	ARCOS/CIRCULAR C4 2000W. HIT	C4 - Circular/semiextensiva	1.409,67 € (19,4)		1X2000	MN	cable - arco corto/largo	0,26	RAL 9006
0631453200	ARCOS/CIRCULAR C5 2000W. HIT	C5 - Circular/extensiva	1.409,67 € (19,4)		1X2000	MN	cable - arco corto	0,26	RAL 9006
0631463200	ARCOS/CIRCULAR C6 2000W. HIT	C6 - Circular/ultra extensiva	1.409,67 € (19,4)		1X2000	MN	cable - arco corto	0,26	RAL 9006
0631300201	(A) REJILLA DE PROTECCION ARCOS 2000W		147,98 €	---	---	---	---	---	---
0631300202	(B) REJILLA DE PROTECCIÓN ACERO INOXIDABLE ARCOS 2000W		483,15 €	---	---	---	---	---	---
0631300203	(C) BISERA CIRCULAR ARCOS 2000W		483,15 €	---	---	---	---	---	---
0631300204	(D) ACCESORIO ANTIDESLUMBRANTE ARCOS/SIMETRICO 2000W		291,63 €	---	---	---	---	---	---
0631300205	(E) ACCESORIO ANTIDESLUMBRANTE ARCOS/ASIMETRICO 2000W		154,83 €	---	---	---	---	---	---
200220006	LAMPARA OSRAM HQI-TS 2000W/NDL/S K12S		459,19 €	---	2000	MN	cable	Arco corto 11,3A 4400k	
200220005	LAMPARA OSRAM HQI-TS 2000W/D/S K12S		504,68 €	---	2000	MN	cable	Arco corto 11,5A 5900k	
06025120005	EQUIPO ELECTRICO 2000W. COFRE ALUMINIO IP 65		524,30 €	---	2000		Sin arrancador	2400.34, 10,3A/11,3A, 380/400V	

PROYECTORES DESCARGA

Materiales: Cuerpo en aluminio inyectado, cierre de cristal templado.

CODIGO	REFERENCIA	P.V.P.	Kg.
0632610012	LUX/C-1000W. HIT a 230V.	522,64 €	(20,4)
0632610012L	LUX/C-1000W. HIT a 230V. con lámpara	695,76 €	(21,0)
0632611012	LUX/C-1000W. HPS a 230V.	549,85 €	(20,9)
0632611012L	LUX/C-1000W. HPS a 230V. con lámpara	706,45 €	(21,5)

Lira en acero galvanizado al fuego, con dispositivo goniométrico.

Tornillería en acero inoxidable.

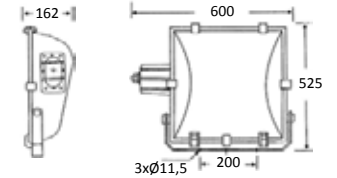
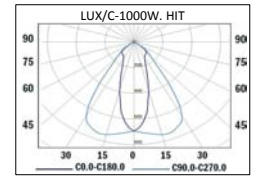
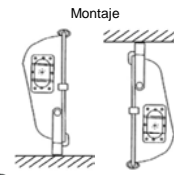
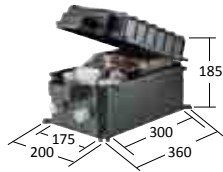

Materiales: Cuerpo en aluminio inyectado, cierre de cristal templado.

CODIGO	REFERENCIA	P.V.P.	Kg.
06326010011	LUX/M-1000W. HIT a 230V.	588,51 €	(26,1)
06326010011L	LUX/M-1000W. HIT a 230V. con lámpara	761,63 €	(26,7)
0632610112	LUX/M-1000W. HPS a 230V.	612,08 €	(26,6)
0632610112L	LUX/M-1000W. HPS a 230V. con lámpara	768,68 €	(27,3)

Lira en acero galvanizado al fuego, con dispositivo goniométrico.

Tornillería en acero inoxidable.

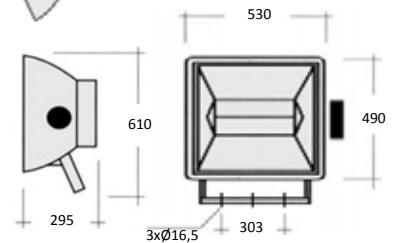
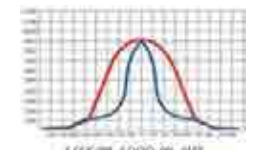
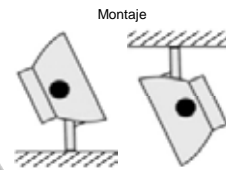
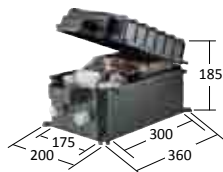

Materiales: Cuerpo en aluminio inyectado, cierre de cristal templado.

CODIGO	REFERENCIA	P.V.P.	Kg.
0632620011	LUX/M-2000W. HIT a 230V.	716,04 €	(33,4)
0632620011L	LUX/M-2000W. HIT a 230V. con lámpara	997,59 €	(34,1)
0632621011	LUX/M-2000W. HIT a 380V.	716,04 €	(33,4)
0632621011L	LUX/M-2000W. HIT a 380V. con lámpara	997,59 €	(34,1)

Lira en acero galvanizado al fuego, con dispositivo goniométrico.

Tornillería en acero inoxidable.

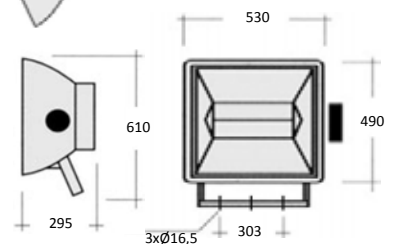
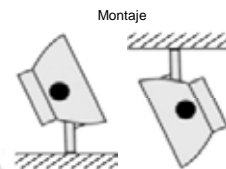
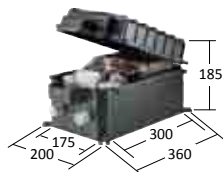

Materiales: Cuerpo en aluminio inyectado, cierre de cristal templado.

CODIGO	REFERENCIA	P.V.P.	Kg.
0612012503	RES-250W. HPS a 230V.	166,62 €	(9,7)
0612012503L	RES-250W. HPS a 230V. con lámpara	193,32 €	(9,9)
0612014003	RES-400W. HPS a 230V.	179,29 €	(11,0)
0612014003L	RES-400W. HPS a 230V. con lámpara	209,74 €	(11,2)
0612022505	REH-250W. HIT a 230V.	169,97 €	(8,9)
0612022505L	REH-250W. HIT a 230V. con lámpara	215,24 €	(9,1)
0612024005	REH-400W. HIT a 230V.	182,64 €	(9,8)
0612024005L	REH-400W. HIT a 230V. con lámpara	227,91 €	(10,0)

Color estándar negro, bajo consulta en color gris.

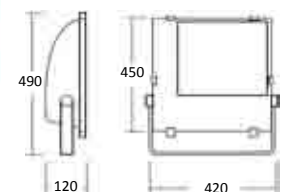
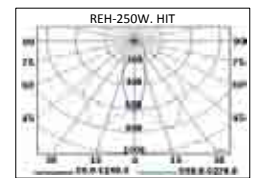
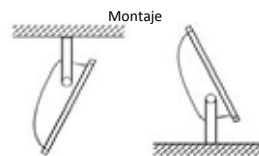

PROYECTORES DESCARGA

Materiales: Cuerpo en aluminio inyectado, cierre de cristal templado.

CODIGO	REFERENCIA	P.V.P.	Kg.
062205250	TPS-250W. HPS a 230V.	183,99 €	(11,7)
062205250L	TPS-250W. HPS a 230V. con lámpara	210,69 €	(11,9)
062205400	TPS-400W. HPS a 230V.	196,66 €	(12,9)
062205400L	TPS-400W. HPS a 230V. con lámpara	227,11 €	(13,1)
062206250	TPH-250W. HIT a 230V.	187,34 €	(11,8)
062206250L	TPH-250W. HIT a 230V. con lámpara	232,61 €	(12,0)
062206400	TPH-400W. HIT a 230V.	200,02 €	(11,8)
062206400L	TPH-400W. HIT a 230V. con lámpara	245,29 €	(12,0)

TPS y TPH - REFLECTOR SIMETRICO.

VERSION ASIMETRICA (TPS/A ó TPH/A), mismo precio que simétrico.

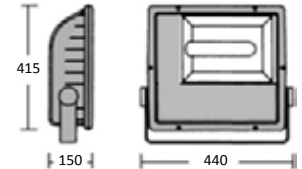
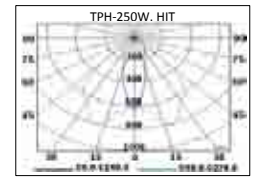
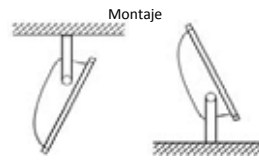

Materiales: Cuerpo en aluminio inyectado, cierre de cristal templado.

CODIGO	REFERENCIA	P.V.P.	Kg.
0602012501	PRS/C-250W. HPS a 230V.	144,72 €	(11,7)
0602012501L	PRS/C-250W. HPS a 230V. con lámpara	171,42 €	(11,9)
0602014001	PRS/C-400W. HPS a 230V.	157,39 €	(12,9)
0602014001L	PRS/C-400W. HPS a 230V. con lámpara	187,84 €	(13,1)
0602022501	PRH/C-250W. HIT a 230V.	148,08 €	(11,8)
0602022501L	PRH/C-250W. HIT a 230V. con lámpara	193,35 €	(12,0)
0602024001	PRH/C-400W. HIT a 230V.	160,75 €	(11,8)
0602024001L	PRH/C-400W. HIT a 230V. con lámpara	206,02 €	(12,0)

TPS y TPH - REFLECTOR SIMETRICO.

VERSION ASIMETRICA (TPS/A ó TPH/A), mismo precio que simétrico.

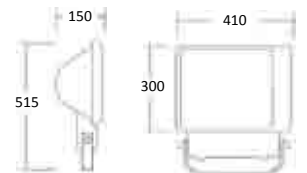
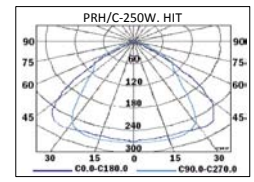
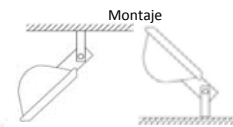

Materiales: Cuerpo en aluminio inyectado, cierre de cristal templado.

CODIGO	REFERENCIA	P.V.P.	Kg.
061214070	TCS-70W. HST-DE a 230V.	125,58 €	(4,4)
061214150	TCS-150W. HST-DE a 230V.	137,84 €	(4,7)
061213070	TCH-70W. HIT-DE a 230V.	125,58 €	(4,4)
061213070L	TCH-70W. HIT-DE a 230V. con lámpara	149,43 €	(4,5)
061213150	TCH-150W. HIT-DE a 230V.	137,84 €	(4,7)
061213150L	TCH-150W. HIT-DE a 230V. con lámpara	161,69 €	(4,8)

TCS y TCH - REFLECTOR SIMETRICO.

VERSION ASIMETRICA (TCS/A ó TCH/A), mismo precio que simétrico.

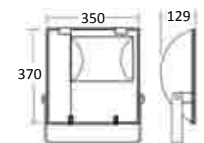
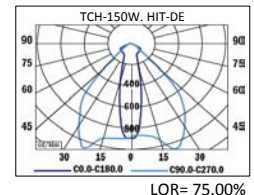
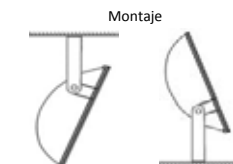

CODIGO	REFERENCIA	P.V.P.	Kg.
061214250	TCS-250W. HPS a 230V.	198,89 €	(9,0)
061214250L	TCS-250W. HPS a 230V. con lámpara	225,59 €	(9,1)
061214400	TCS-400W. HPS a 230V.	218,59 €	(9,1)
061214400L	TCS-400W. HPS a 230V. con lámpara	249,04 €	(9,2)
061213250	TCH-250W. HIT a 230V.	198,89 €	(9,0)
061213250L	TCH-250W. HIT a 230V. con lámpara	244,16 €	(9,1)
061213400	TCH-400W. HIT a 230V.	218,59 €	(9,1)
061213400L	TCH-400W. HIT a 230V. con lámpara	263,86 €	(9,2)

TCS y TCH - REFLECTOR SIMETRICO.

VERSION ASIMETRICA (TCS/A ó TCH/A), mismo precio que simétrico.

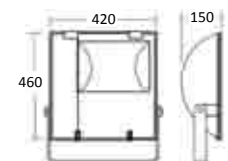
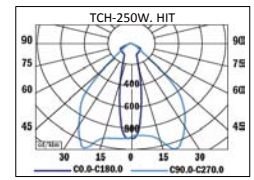

PROYECTORES DESCARGA

Materiales: Cuerpo en aluminio inyectado, cierre de cristal templado.

CODIGO	REFERENCIA	P.V.P.	Kg.
06420702	TELEC-70W. HIT-DE a 230V.	93,64 €	(4,3)
06420702L	TELEC-70W. HIT-DE a 230V. con lámpara	106,70 €	(4,4)
06421502	TELEC-150W. HIT-DE a 230V.	117,49 €	(5,2)
06421502L	TELEC-150W. HIT-DE a 230V. con lámpara	130,55 €	(5,3)



Negro

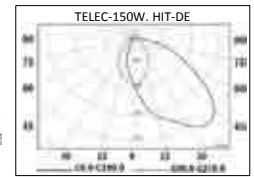
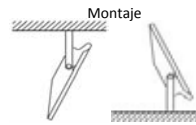

Marfil claro

Gris

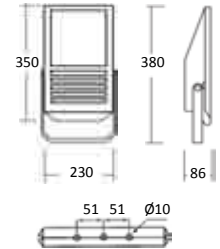
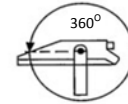

Materiales: Cuerpo en aluminio inyectado, cierre de cristal templado.

CODIGO	REFERENCIA	P.V.P.	Kg.
0640101070	PARK/SYM-70W. HST-DE a 230V.	106,70 €	(3,8)
0640102070	PARK/SYM-70W. HIT-DE a 230V.	106,70 €	(3,8)
0640102070L	PARK/SYM-70W. HIT-DE a 230V. con lámpara	130,55 €	(3,9)

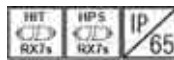

SIMETRICO

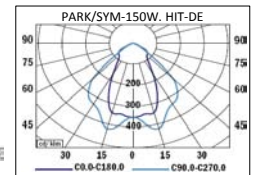
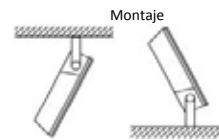

LOR= 62.50%



INTENSIVO

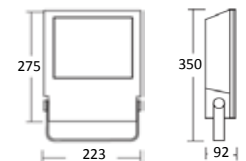

0640111070	PARK/SPOT-70W. HST-DE a 230V.	106,70 €	(3,8)
0640112070	PARK/SPOT-70W. HIT-DE a 230V.	106,70 €	(3,8)
0640112070L	PARK/SPOT-70W. HIT-DE a 230V. con lámpara	130,55 €	(3,9)

Materiales: Cuerpo en aluminio pintado en color gris, difusor en cristal opalino.

CODIGO	REFERENCIA	P.V.P.	Kg.
06460070	FC-70W. HIT-DE a 230V. (SIN ALETAS CORTAFLUJOS)	134,26 €	(3,3)
06460070	FC-150W. HIT-DE a 230V. (SIN ALETAS CORTAFLUJOS)	146,21 €	(4,6)
064609001	BDR (FC) (ALETAS CORTAFLUJOS)	27,92 €	---



Montaje

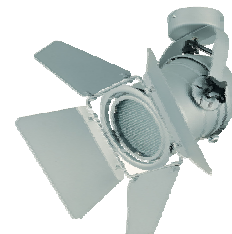
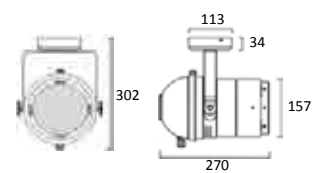

Materiales: Cuerpo en aluminio pintado en color gris, difusor en cristal opalino.

CODIGO	REFERENCIA	P.V.P.	Kg.
06480170	LSH-70W. HIT-DE a 230V.	125,10 €	(4,0)



Montaje

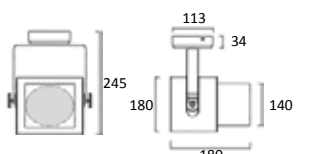
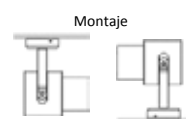

06491070	LSCD-70W. HIT-DE a 230V.	126,70 €	(4,4)
06491150	LSCD-150W. HIT-DE a 230V.	139,30 €	(5,4)

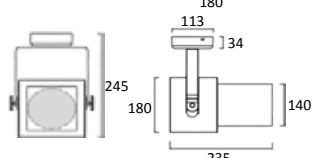
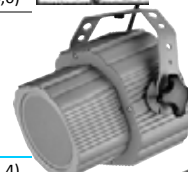

PROYECTOR LED



Materiales: Cuerpo en fundición de aluminio, difusor de material termoplástico opalino.

CODIGO	REFERENCIA	Indice rendimiento de color CRI (Ra)	Temperatura de color CCT (k)	P.V.P.	Kg.	LED	IP 65
PF1L054	FOCUS MAX-54W. 3500lm/733	>70	3300	817,89 €	(7,5)		

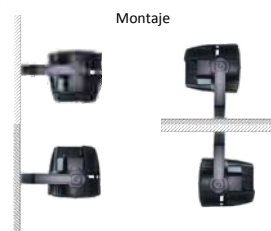
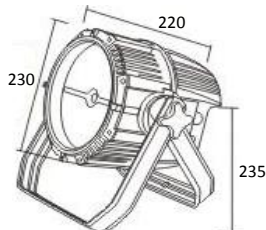

PROYECTORES DESCARGA SERIE RESIDENCIAL

Materiales: Cuerpo en fundición de aluminio, reflector de aluminio brillante, cierre de cristal templado.

CODIGO	REFERENCIA	P.V.P.	Kg.	HIT	IP 65
06626403035	VILLA-160-G12 35W. HIT	204,08 €	(3,9)		
06626403070	VILLA-160-G12 70W. HIT	204,08 €	(4,0)		

Tornillería de acero inoxidable 18/8, prensaestopas metálico de alta calidad.

Esmaltado en color gris oscuro de alta resistencia a la corrosión.

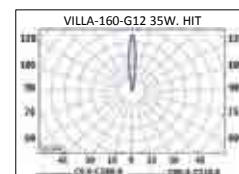
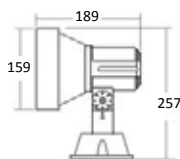
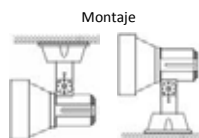

LOR= 92.00%

Materiales: Cuerpo en fundición de aluminio, reflector de aluminio brillante, cierre de cristal templado.

CODIGO	REFERENCIA	P.V.P.	Kg.	HIT	IP 65
06626303070	VILLA-240-RX7S 70W. HIT-DE	203,81 €	(4,8)		
06626303150	VILLA-240-RX7S 150W. HIT-DE	223,74 €	(4,9)		

Tornillería de acero inoxidable 18/8, prensaestopas metálico de alta calidad.

Esmaltado en color gris oscuro de alta resistencia a la corrosión.

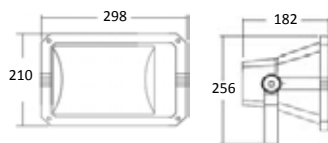
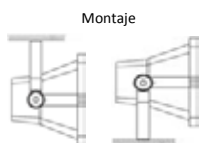

Materiales: Cuerpo en fundición de aluminio, reflector de aluminio brillante, cierre de cristal templado.

CODIGO	REFERENCIA	P.V.P.	Kg.	HIT	IP 65
06626203070	VILLA-260-G12 70W. HIT	238,90 €	(5,3)		
06626203150	VILLA-260-G12 150W. HIT	249,76 €	(5,4)		

Tornillería de acero inoxidable 18/8, prensaestopas metálico de alta calidad.

Esmaltado en color gris oscuro de alta resistencia a la corrosión.

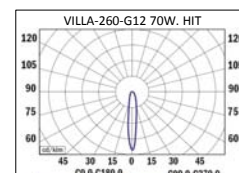
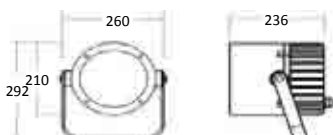

LOR= 92.00%

PROYECTORES DESCARGA / T-5 SERIE RESIDENCIAL

Materiales: Cuerpo en aluminio extruido, reflector de aluminio anodizado martelado, marco de fundición de aluminio, cristal templado.

CODIGO	REFERENCIA	P.V.P.	Kg.
06627203214	LYRIS-REF - 2x14W. G5 230V. T5 H.F.	185,50 €	(4,1)

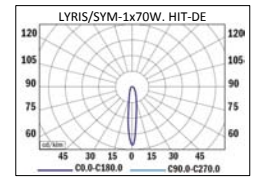

Tornillería de acero inoxidable 18/8, prensaestopas metálico de alta calidad.
Esmaltado en color gris oscuro de alta resistencia a la corrosión.

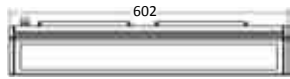
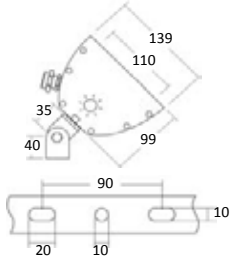

06627213070	LYRIS-SYM - 1x70W. RX7s 230V. HIT-DE	200,22 €	(5,4)
06627223070	LYRIS-ASYM - 1x70W. RX7s 230V. HIT-DE	200,22 €	(5,4)

Tornillería de acero inoxidable 18/8, prensaestopas metálico de alta calidad.
Esmaltado en color gris oscuro de alta resistencia a la corrosión.

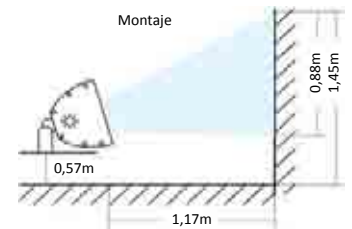
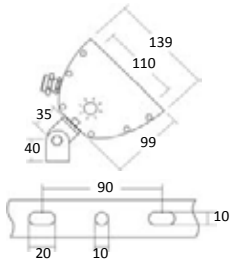

06627213150	LYRIS-SYM - 1x150W. RX7s 230V. HIT-DE	224,79 €	(5,6)
06627223150	LYRIS-ASYM - 1x150W. RX7s 230V. HIT-DE	211,23 €	(5,6)
06627233150	LYRIS-SYM - 1x150W. E40 230V. HIT	219,37 €	(5,6)

Tornillería de acero inoxidable 18/8, prensaestopas metálico de alta calidad.
Esmaltado en color gris oscuro de alta resistencia a la corrosión.

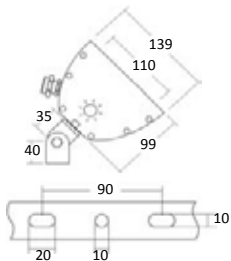

BAÑADOR DE EMBELLECIMIENTO SERIE RESIDENCIAL

Materiales: Cuerpo en aluminio extruido, reflector asimétrico de aluminio anodizado, marco de fundición de aluminio, cristal templado.

CODIGO	REFERENCIA	P.V.P.	Kg.
06627103114	ATTIS/ASYM - 1x14W. G5 230V. T5 H.F.	185,71 €	(3,2)
06627103121	ATTIS/ASYM - 1x21W. G5 230V. T5 H.F.	217,73 €	(4,4)
06627103139	ATTIS/ASYM - 1x39W. G5 230V. T5 H.F.	218,42 €	(4,4)
06627103128	ATTIS/ASYM - 1x28W. G5 230V. T5 H.F.	259,62 €	(5,8)
06627103154	ATTIS/ASYM - 1x54W. G5 230V. T5 H.F.	260,31 €	(5,8)



1x14W. - L= 630
1x21/1x39W. - L= 930
1x28/1x54W. - L=1230

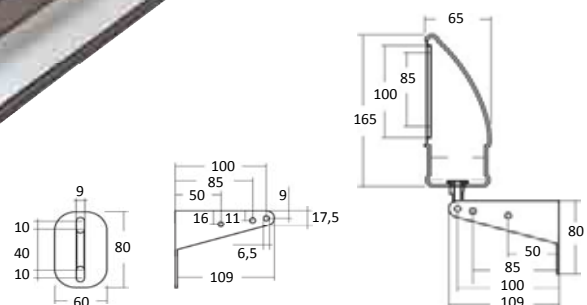
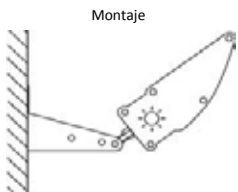
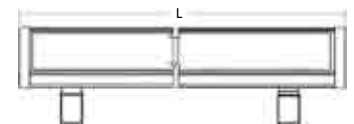

APLIQUES DE PARED DESCARGA SERIE RESIDENCIAL

Materiales: Cuerpo en aluminio extruido, reflector de aluminio anodizado, marco de fundición de aluminio, cristal templado antivandálico.

CODIGO	REFERENCIA	P.V.P.	Kg.
06627303035	NELL - 1x35W. G12 230V. HIT	205,03 €	(4,3)
06627303070	NELL - 1x70W. G12 230V. HIT	213,96 €	(4,3)
06627303150	NELL - 1x150W. E27 230V. HIT	240,51 €	(4,5)

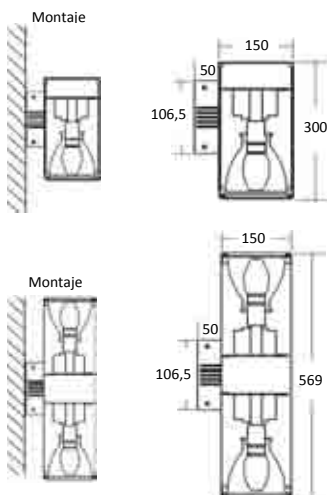
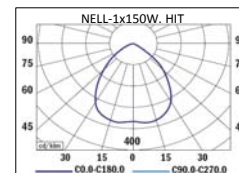

06627303235	NELL - 2x35W. G12 230V. HIT	344,35 €	(5,5)
06627303270	NELL - 2x70W. G12 230V. HIT	362,07 €	(5,5)
06627303215	NELL - 2x150W. E27 230V. HIT	437,96 €	(5,7)

APLIQUES ADOSABLES / PARED DESCARGA SERIE RESIDENCIAL

Materiales: Cuerpo en aluminio extruido, reflector de aluminio brillante, marco de fundición de aluminio, cristal templado.

CODIGO	REFERENCIA	P.V.P.	Kg.
06627403070	WAKO-1-1x70W. RX7s 230V. HIT	228,12 €	(3,1)
06627403150	WAKO-1-1x150W. RX7s 230V. HIT	243,54 €	(3,1)

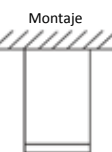
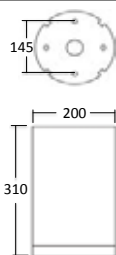

06627413070	WAKO-2-1x70W. RX7s 230V. HIT	246,40 €	(3,6)
06627413150	WAKO-2-1x150W. RX7s 230V. HIT	261,83 €	(3,6)

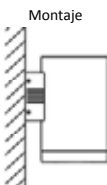
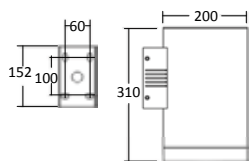

06627423070	WAKO-3-2x70W. RX7s 230V. HIT	384,16 €	(5,1)
06627423150	WAKO-3-2x150W. RX7s 230V. HIT	415,00 €	(5,1)

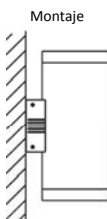
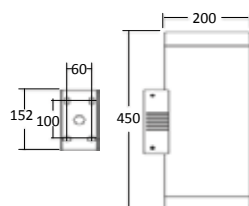

PROYECTORES HALOGENOS DESCARGA LAMPARAS COMPACTAS

Materiales: Cuerpo en aluminio inyectado, cierre de cristal templado.

CODIGO	REFERENCIA	P.V.P.	Kg.
066260150NR	PCR-150W. Negro con lámpara	9,44 €	(0,5)
066260150BR	PCR-150W. Blanco con lámpara	9,44 €	(0,5)

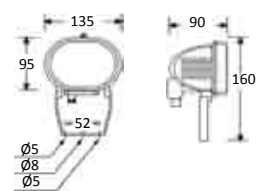
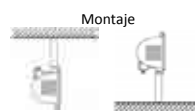

Materiales: Cuerpo en aluminio inyectado, cierre de cristal templado.

CODIGO	REFERENCIA	P.V.P.	Kg.
06621R	PCR-500W.	13,73 €	(0,9)

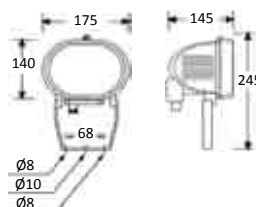
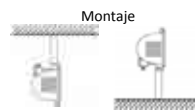

Materiales: Cuerpo en aluminio inyectado, cierre de cristal templado.

CODIGO	REFERENCIA	P.V.P.	Kg.
066260150N	PC-150W. Negro con lámpara	8,67 €	(0,5)
066260150B	PC-150W. Blanco con lámpara	8,67 €	(0,5)

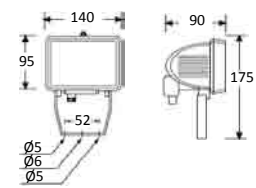
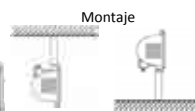

Materiales: Cuerpo en aluminio inyectado, cierre de cristal templado.

CODIGO	REFERENCIA	P.V.P.	Kg.
06621	PC-500W.	13,15 €	(0,9)

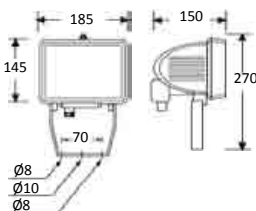
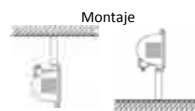

Materiales: Cuerpo en aluminio inyectado, cierre de cristal templado.

CODIGO	REFERENCIA	P.V.P.	Kg.
06622	PC-1000W.	31,57 €	(1,9)

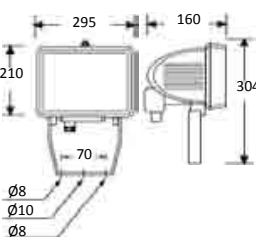
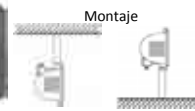

Materiales: Cuerpo en aluminio inyectado, cierre de cristal templado.

CODIGO	REFERENCIA	P.V.P.	Kg.
06623	PC-1500W.	48,88 €	(2,6)

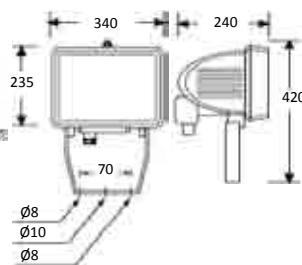
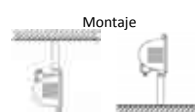

Materiales: Cuerpo termoplástico autoextinguible, cierre de policarbonato con cristal templado interior.



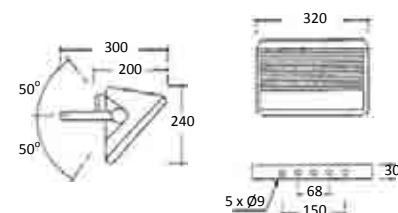

CODIGO	REFERENCIA	P.V.P.	Kg.
06920803	PXM-80W. V.M. a 230V.	104,02 €	(3,6)
06920701	PXS-70W. H.P.S. a 230V.	115,28 €	(3,7)
06920702	PXH-70W. H.I.T.-E a 230V.	119,09 €	(3,7)



CODIGO	REFERENCIA	P.V.P.	Kg.
069200024	PX-PL-L-2x18W. A.F. a 230V.	53,77 €	(2,7)



Materiales: Cuerpo en aluminio inyectado, difusor de PMMA microprismático.

CODIGO	REFERENCIA	Indice rendimiento de color CRI (Ra)	Temperatura de color CCT (k)	P.V.P. Kg.	 
06531L1105	INDUS IP65-106W. LED 11050lm/850	>80	5000	PENDIENTE DE FABRICACION	 

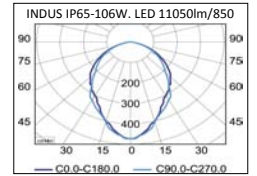
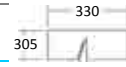

ACCESORIOS





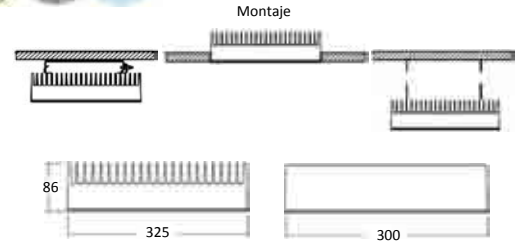
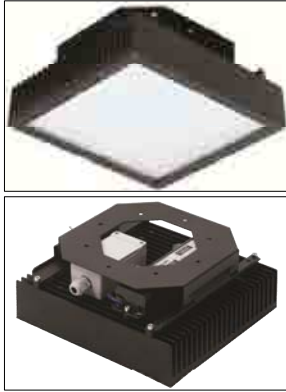





















































































15620004	SET DE SUSPENSION INDUS IP65 (BAJO PEDIDO)	PENDIENTE DE FABRICACION			
----------	---	--------------------------	--	--	--

Estándar en color Negro, bajo consulta en color blanco.



PROYECTORES DESCARGA

Materiales: Proyector adosable, cuerpo en chapa de acero, cristal cierre transparente.

CODIGO	REFERENCIA		P.V.P. Kg.	     
065316250	PST/S-IP65-250W. V.M. a 230V.	E-40	239,90 € (13,1)	     
065316400	PST/S-IP65-400W. V.M. a 230V.	E-40	252,29 € (14,0)	     
065317070	PST/S-IP65-70W. V.P.S. a 230V.	E-27	236,26 € (11,7)	     
065317150	PST/S-IP65-150W. V.P.S. a 230V.	E-40	247,41 € (13,1)	     
065317250	PST/S-IP65-250W. V.P.S. a 230V.	E-40	260,03 € (13,1)	     
065317250L	PST/S-IP65-250W. V.P.S. a 230V. con lámpara	E-40	286,73 € (13,3)	     
065317400	PST/S-IP65-400W. V.P.S. a 230V.	E-40	271,52 € (14,0)	     
065317400L	PST/S-IP65-400W. V.P.S. a 230V. con lámpara	E-40	301,97 € (14,2)	     
065318070	PST/S-IP65-70W. H.I.T. a 230V.	E-27	236,26 € (11,7)	     
065318150	PST/S-IP65-150W. H.I.T. a 230V.	E-40	247,41 € (13,1)	     
065318250	PST/S-IP65-250W. H.I.T. a 230V.	E-40	263,07 € (13,1)	     
065318250L	PST/S-IP65-250W. H.I.T. a 230V. con lámpara	E-40	308,34 € (13,3)	     
065318400	PST/S-IP65-400W. H.I.T. a 230V.	E-40	274,56 € (14,0)	     
065318400L	PST/S-IP65-400W. H.I.T. a 230V. con lámpara	E-40	319,83 € (14,2)	     
065000	REJILLA DE PROTECCION PST		39,78 € ---	
---	CONMUTADOR DE EMERGENCIA PST		98,55 € ---	

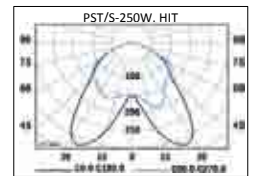
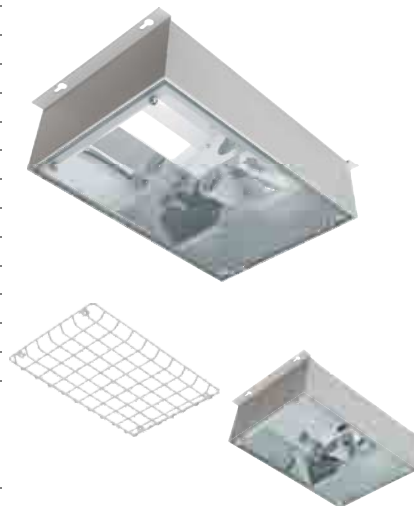





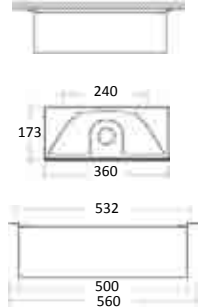





















































































LOR= 75.35%

Montaje



VERSION ASIMETRICA (PST/S/ASYM), mismo precio que simétrico.

Materiales: Proyector empotrable, cuerpo en chapa de acero, cristal cierre transparente.

CODIGO	REFERENCIA		P.V.P. Kg.	     
065416250	PST/GA-IP65-250W. V.M. a 230V.	E-40	258,00 € (13,6)	     
065416400	PST/GA-IP65-400W. V.M. a 230V.	E-40	270,39 € (14,5)	     
065417070	PST/GA-IP65-70W. V.P.S. a 230V.	E-27	254,36 € (11,8)	     
065417150	PST/GA-IP65-150W. V.P.S. a 230V.	E-40	265,51 € (13,2)	     
065417250	PST/GA-IP65-250W. V.P.S. a 230V.	E-40	278,12 € (13,6)	     
065417250L	PST/GA-IP65-250W. V.P.S. a 230V. con lámpara	E-40	304,82 € (13,8)	     
065417400	PST/GA-IP65-400W. V.P.S. a 230V.	E-40	289,61 € (14,5)	     
065417400L	PST/GA-IP65-400W. V.P.S. a 230V. con lámpara	E-40	320,06 € (14,7)	     
065418070	PST/GA-IP65-70W. H.I.T. a 230V.	E-27	254,36 € (11,8)	     
065418150	PST/GA-IP65-150W. H.I.T. a 230V.	E-40	265,51 € (13,2)	     
065418250	PST/GA-IP65-250W. H.I.T. a 230V.	E-40	281,17 € (13,6)	     
065418250L	PST/GA-IP65-250W. H.I.T. a 230V. con lámpara	E-40	326,44 € (13,8)	     
065418400	PST/GA-IP65-400W. H.I.T. a 230V.	E-40	292,65 € (14,5)	     
065418400L	PST/GA-IP65-400W. H.I.T. a 230V. con lámpara	E-40	337,92 € (14,7)	     
065000	REJILLA DE PROTECCION PST		39,78 € ---	
---	CONMUTADOR DE EMERGENCIA PST		98,55 € ---	

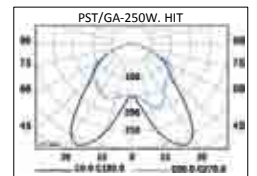
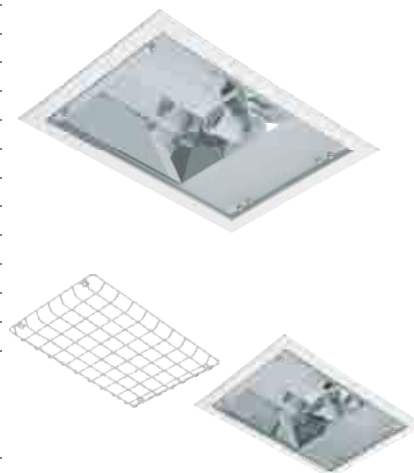

LOR= 75.35%

Montaje

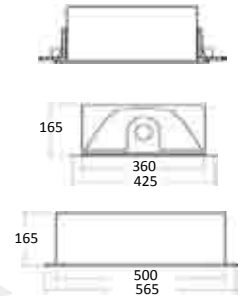

VERSION ASIMETRICA (PST/GA/ASYM), mismo precio que simétrico.

BALIZAS EMPOTRABLES DE SUELO SERIE RESIDENCIAL

Materiales: Cuerpo en fundición de aluminio, cierre de fundición de aluminio con cristal de seguridad de 12 mm de espesor, caja empotrable de poliamida.

CODIGO	REFERENCIA	P.V.P.	Kg.
4002020023	DOE-ASYM-1x7-23W.* E27 230V. TC-TSE	227,21 €	(6,5)
4002023070	DOE-ASYM-70W.** RX7s 230V. HIT-DE	302,72 €	(7,7)

* Categoría C4, según Norma UNE-EN 60598-2-13.

** Categoría C1, según Norma UNE-EN 60598-2-13.

Tornillería de acero inoxidable 18/8, prensaestopas metálico de alta calidad.

Esmaltado en color negro de alta resistencia a la corrosión.

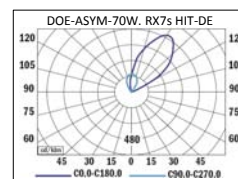

Materiales: Cuerpo en fundición de aluminio, cierre de aluminio extruido, difusor de cristal con 6 ranuras/salidas de luz caja empotrable de poliamida.

CODIGO	REFERENCIA	P.V.P.	Kg.
4002003070	DOD-6 - 70W.* G12 230V. HIT	368,61 €	(8,0)

* Categoría C1, según Norma UNE-EN 60598-2-13.

Carga máxima 2.000 Kg.

Tornillería de acero inoxidable 18/8, prensaestopas metálico de alta calidad.

Esmaltado en color gris oscuro de alta resistencia a la corrosión.

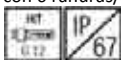

Materiales: Cuerpo en aluminio extruido con cabezal de poliamida, cierre de fundición de aluminio con cristal de seguridad, caja empotrable de poliamida.

CODIGO	REFERENCIA	P.V.P.	Kg.
4002013070	DOF - 70W.* G12 230V. HIT	375,80 €	(7,7)
4002003070	DOF - 150W.* G12 230V. HIT	391,13 €	(7,9)

* Categoría C1, según Norma UNE-EN 60598-2-13.

Carga máxima 2.000 Kg.

Tornillería de acero inoxidable 18/8, prensaestopas metálico de alta calidad.

Esmaltado en color gris oscuro de alta resistencia a la corrosión.

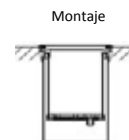
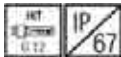

Materiales: Cuerpo en aluminio extruido en su color natural, tapas finales de aluminio extruido en color gris RAL 9006, cierre de cristal satinado mate de 8mm. de espesor, reflector de aluminio anodizado.

CODIGO	REFERENCIA	P.V.P.	Kg.
4002033114	WOI/SYM-1x14W. H.F. T5	117,46 €	(2,2)
4002033121	WOI/SYM-1x21W. H.F. T5	189,35 €	(3,2)
4002033128	WOI/SYM-1x28W. H.F. T5	226,74 €	(4,3)

Carga máxima 2.000 Kg.

Tornillería de acero inoxidable 18/8, prensaestopas metálico de alta calidad.

Esmaltado en color gris oscuro de alta resistencia a la corrosión.

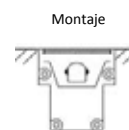
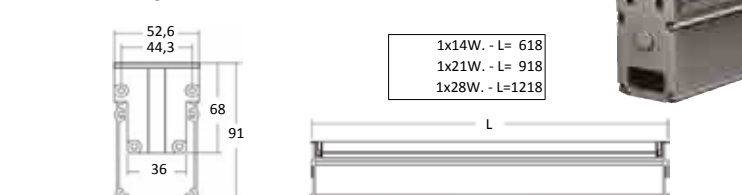

BALIZAS SERIE RESIDENCIAL

Materiales: Cuerpo en aluminio extruido, cabezal de fundición de aluminio, reflector de aluminio brillante, difusor de policarbonato incoloro.

CODIGO	REFERENCIA		P.V.P.	Kg.	TC-TSE	HIT	IP
08020110020	BALI 1 - 1x7-20W.	E27 230V. TC-TSE	347,08 €	(4,2)	E27	G12	54
08020113035	BALI 1 - 35W.	G12 230V. HIT	431,99 €	(5,7)			

Esmaltado en color gris oscuro de alta resistencia a la corrosión.

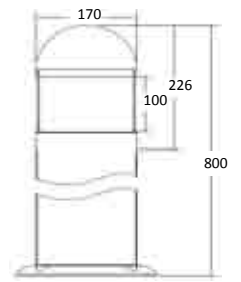

Materiales: Cuerpo en aluminio extruido, cabezal de fundición de aluminio, reflector laminar de aluminio brillante, difusor de policarbonato incoloro.

CODIGO	REFERENCIA		P.V.P.	Kg.	TC-TSE	HIT	IP
08020120020	BALI 2 - 1x7-20W.	E27 230V. TC-TSE	347,08 €	(4,2)	E27	G12	65
08020123035	BALI 2 - 35W.	G12 230V. HIT	431,99 €	(5,7)			

Esmaltado en color gris oscuro de alta resistencia a la corrosión.

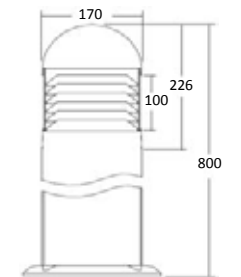

Materiales: Cuerpo en aluminio extruido, cabezal de fundición de aluminio, reflector de aluminio brillante, difusor de policarbonato opal.

CODIGO	REFERENCIA		P.V.P.	Kg.	TC-TSE	HIT	IP
08020130020	BALI 3 - 1x7-20W.	E27 230V. TC-TSE	347,08 €	(4,2)	E27	G12	65
08020133035	BALI 3 - 35W.	G12 230V. HIT	431,99 €	(5,7)			

Esmaltado en color gris oscuro de alta resistencia a la corrosión.

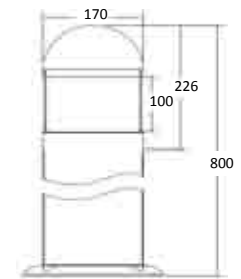

Materiales: Cuerpo en aluminio extruido, cabezal de fundición de aluminio, difusor de policarbonato opal.

CODIGO	REFERENCIA		P.V.P.	Kg.	TC-TSE	IP
08020140020	JAVA 1 - 1x7-20W.	E27 230V. TC-TSE	347,08 €	(3,7)	E27	54

Esmaltado en color gris oscuro de alta resistencia a la corrosión.

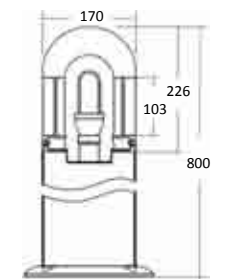
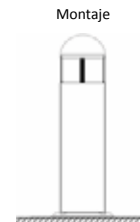

Materiales: Cuerpo en aluminio extruido, cabezal de fundición de aluminio, difusor de policarbonato opal.

CODIGO	REFERENCIA		P.V.P.	Kg.	TC-TSE	IP
08020150020	JAVA 2 - 1x7-20W.	E27 230V. TC-TSE	347,08 €	(3,7)	E27	54

Esmaltado en color gris oscuro de alta resistencia a la corrosión.

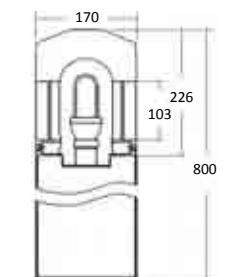

CAMPANAS DECORATIVAS STILO L LED



CAMPANA DECORATIVA STILO L LED



Design by JAN STOFKO

VERSION BASIC 1
cuerpo negro
difusor blanco opal
reflector trasero



VERSION BASIC 2
cuerpo gris
difusor blanco opal
reflector trasero



VERSION BASIC 3
cuerpo blanco
difusor blanco opal
reflector trasero



VERSION BASIC 4
cuerpo blanco
difusor azul cielo
reflector trasero



VERSION EXCLUSIVE 1
cuerpo blanco brillante
difusor blanco brillante
(interior blanco)
reflector trasero



VERSION EXCLUSIVE 2
cuerpo negro brillante
difusor negro brillante
(interior blanco)
reflector trasero



Montaje	Suspension.
Lámparas	LED
Sistema óptico	Reflector.
Distribución luminosa	Directa.
Equipo eléctrico	Equipo de control electrónico EEI=A2. Bajo consulta, equipo de control electrónico regulable DALI EEI=A1.
Materiales	Cuerpo: Policarbonato inyectado, poliamida. Reflector trasero: Aluminio anodizado. Difusor: Policarbonato translucido. Aro: Policarbonato inyectado. Cadena de suspensión: 1,4 mts incluida.
Acabado	Variantes en diferentes colores.

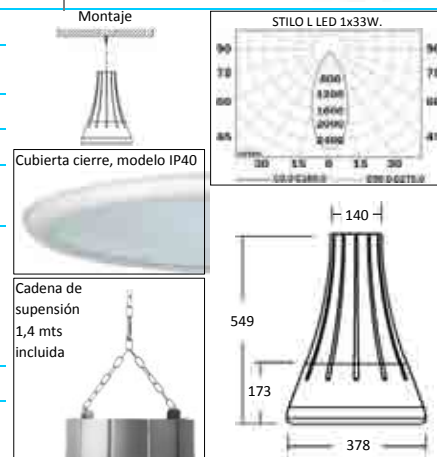

CODIGO	REFERENCIA	VERSION	P.V.P.	Kg.	Flujo Luminoso	Potencia	Eficiencia Modulo LED + Driver	Temperatura de color	Indice rendimiento de color	Refrigeración
0674100317	STILO L LED-IP20 1x17W.	BASIC	676,59 €	(9,0)	1100	17	65	4000	80	Pasiva
0674101317	STILO L LED-IP20 1x17W.	EXCLUSIVE	892,00 €	(9,0)	1100	17	65	4000	80	Pasiva
0674100417	STILO L LED-IP20 1x17W. DALI	BASIC	761,07 €	(9,0)	1100	17	65	4000	80	Pasiva
0674101417	STILO L LED-IP20 1x17W. DALI	EXCLUSIVE	976,48 €	(9,0)	1100	17	65	4000	80	Pasiva
0674100319	STILO L LED-IP20 1x19W.	BASIC	676,59 €	(9,0)	1100	19	58	3000	80	Pasiva
0674101319	STILO L LED-IP20 1x19W.	EXCLUSIVE	892,00 €	(9,0)	1100	19	58	3000	80	Pasiva
0674100419	STILO L LED-IP20 1x19W. DALI	BASIC	761,07 €	(9,0)	1100	19	58	3000	80	Pasiva
0674101419	STILO L LED-IP20 1x19W. DALI	EXCLUSIVE	976,48 €	(9,0)	1100	19	58	3000	80	Pasiva
0674100329	STILO L LED-IP20 1x29W.	BASIC	782,19 €	(9,0)	2000	29	69	4000	80	Pasiva
0674101329	STILO L LED-IP20 1x29W.	EXCLUSIVE	976,48 €	(9,0)	2000	29	69	4000	80	Pasiva
0674100429	STILO L LED-IP20 1x29W. DALI	BASIC	913,12 €	(9,0)	2000	29	69	4000	80	Pasiva
0674101429	STILO L LED-IP20 1x29W. DALI	EXCLUSIVE	1.018,71 €	(9,0)	2000	29	69	4000	80	Pasiva
0674100333	STILO L LED-IP20 1x33W.	BASIC	782,19 €	(9,0)	2000	33	61	3000	80	Pasiva
0674101333	STILO L LED-IP20 1x33W.	EXCLUSIVE	976,48 €	(9,0)	2000	33	61	3000	80	Pasiva
0674100433	STILO L LED-IP20 1x33W. DALI	BASIC	913,12 €	(9,0)	2000	33	61	3000	80	Pasiva
0674101433	STILO L LED-IP20 1x33W. DALI	EXCLUSIVE	1.018,71 €	(9,0)	2000	33	61	3000	80	Pasiva
0674100349	STILO L LED-IP20 1x49W.	BASIC	986,73 €	(9,0)	3000	49	61	4000	80	Activa
0674101349	STILO L LED-IP20 1x49W.	EXCLUSIVE	1.039,23 €	(9,0)	3000	49	61	4000	80	Activa
0674100449	STILO L LED-IP20 1x49W. DALI	BASIC	1.055,52 €	(9,0)	3000	49	61	4000	80	Activa
0674101449	STILO L LED-IP20 1x49W. DALI	EXCLUSIVE	1.108,01 €	(9,0)	3000	49	61	4000	80	Activa
06741003171	STILO L LED-IP40 1x17W.	BASIC	715,17 €	(9,0)	1100	17	65	4000	80	Pasiva
06741013171	STILO L LED-IP40 1x17W.	EXCLUSIVE	930,58 €	(9,0)	1100	17	65	4000	80	Pasiva
06741004171	STILO L LED-IP40 1x17W. DALI	BASIC	799,64 €	(9,0)	1100	17	65	4000	80	Pasiva
06741014171	STILO L LED-IP40 1x17W. DALI	EXCLUSIVE	1.015,05 €	(9,0)	1100	17	65	4000	80	Pasiva
06741003191	STILO L LED-IP40 1x19W.	BASIC	715,17 €	(9,0)	1100	19	58	3000	80	Pasiva
06741013191	STILO L LED-IP40 1x19W.	EXCLUSIVE	930,58 €	(9,0)	1100	19	58	3000	80	Pasiva
06741004191	STILO L LED-IP40 1x19W. DALI	BASIC	799,64 €	(9,0)	1100	19	58	3000	80	Pasiva
06741014191	STILO L LED-IP40 1x19W. DALI	EXCLUSIVE	1.015,05 €	(9,0)	1100	19	58	3000	80	Pasiva
06741003291	STILO L LED-IP40 1x29W.	BASIC	820,76 €	(9,0)	2000	29	69	4000	80	Pasiva
06741013291	STILO L LED-IP40 1x29W.	EXCLUSIVE	1.015,05 €	(9,0)	2000	29	69	4000	80	Pasiva
06741004291	STILO L LED-IP40 1x29W. DALI	BASIC	951,70 €	(9,0)	2000	29	69	4000	80	Pasiva
06741014291	STILO L LED-IP40 1x29W. DALI	EXCLUSIVE	1.057,29 €	(9,0)	2000	29	69	4000	80	Pasiva
06741003331	STILO L LED-IP40 1x33W.	BASIC	820,76 €	(9,0)	2000	33	61	3000	80	Pasiva
06741013331	STILO L LED-IP40 1x33W.	EXCLUSIVE	1.015,05 €	(9,0)	2000	33	61	3000	80	Pasiva
06741004331	STILO L LED-IP40 1x33W. DALI	BASIC	851,70 €	(9,0)	2000	33	61	3000	80	Pasiva
06741014331	STILO L LED-IP40 1x33W. DALI	EXCLUSIVE	1.057,29 €	(9,0)	2000	33	61	3000	80	Pasiva
06741003491	STILO L LED-IP40 1x49W.	BASIC	1.025,31 €	(9,0)	3000	49	61	4000	80	Activa
06741013491	STILO L LED-IP40 1x49W.	EXCLUSIVE	1.077,80 €	(9,0)	3000	49	61	4000	80	Activa
06741004491	STILO L LED-IP40 1x49W. DALI	BASIC	1.094,10 €	(9,0)	3000	49	61	4000	80	Activa
06741014491	STILO L LED-IP40 1x49W. DALI	EXCLUSIVE	1.146,59 €	(9,0)	3000	49	61	4000	80	Activa

CAMPANAS DECORATIVAS STILO L / XL

CAMPANA DECORATIVA STILO L / XL

VERSION BASIC 1
cuerpo negro
difusor blanco opal
reflector trasero
o
reflector liso (XL)
reflector facetado (L)



VERSION BASIC 2
cuerpo gris
difusor blanco opal
reflector trasero
o
reflector liso (XL)
reflector facetado (L)



VERSION BASIC 3
cuerpo blanco
difusor blanco opal
reflector trasero
o
reflector liso (XL)
reflector facetado (L)



VERSION BASIC 4
cuerpo blanco
difusor azul cielo
reflector trasero



VERSION INDUSTRIAL 1
cuerpo negro
difusor translucido
reflector liso (XL)
reflector facetado (L)



VERSION INDUSTRIAL 2
cuerpo gris
difusor translucido
reflector liso (XL)
reflector facetado (L)



VERSION INDUSTRIAL 3
cuerpo blanco
reflector liso (XL)
reflector facetado (L)



VERSION EXCLUSIVE 1
cuerpo blanco brillante
difusor blanco brillante
(interior blanco)
reflector trasero
o
reflector liso (XL)
reflector facetado (L)



VERSION EXCLUSIVE 2
cuerpo negro brillante
difusor negro brillante
(interior blanco)
reflector trasero
o
reflector liso (XL)
reflector facetado (L)



Design by JAN STOFKO

Montaje

Suspension.

Lámparas

Fluorescentes compactas TC-TEL , Sodio blanco STH , halogenuros metálicos HIT  

Sistema óptico

Reflector.

Distribución luminosa

Directa, version Directa-Indirecta bajo consulta.

Equipo eléctrico

Fluorescencia: Balasto electrónico EEI=A2.
Descarga: Reactancia magnética, arrancador, condensador.

Materiales

Cuerpo: Policarbonato inyectado, poliamida.
Reflector: Aluminio anodizado liso/facetado.
Difusor: Policarbonato inyectado opal translucido.
Aro: Policarbonato inyectado.
Cadena de suspensión: 1,4 mts incluida.

Acabado

Variantes en diferentes colores.

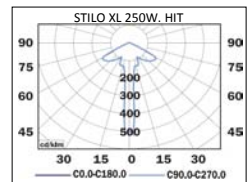

Versión Directa-Indirecta (DIR-INDIR) bajo consulta



Cubierta cierre, modelo IP40

CODIGO	REFERENCIA	VERSION	P.V.P.	Kg.	Óptica	Potencia	Lámpara	Portalámparas
06741103126	STILO L-IP20 1x26W. H.F.	BASIC	574,34 €	(8,5)	Reflector trasero	26 W.	TC-TEL	GX24q
06741113126	STILO L-IP20 1x26W. H.F.	EXCLUSIVE	618,55 €	(8,5)	Reflector trasero	26 W.	TC-TEL	GX24q
06741113132	STILO L-IP20 1x32W. H.F.	BASIC	574,34 €	(8,5)	Reflector trasero	32 W.	TC-TEL	GX24q
06741113132	STILO L-IP20 1x32W. H.F.	EXCLUSIVE	618,55 €	(8,5)	Reflector trasero	32 W.	TC-TEL	GX24q
06741113142	STILO L-IP20 1x42W. H.F.	BASIC	574,34 €	(8,5)	Reflector trasero	42 W.	TC-TEL	GX24q
06741113142	STILO L-IP20 1x42W. H.F.	EXCLUSIVE	618,55 €	(8,5)	Reflector trasero	42 W.	TC-TEL	GX24q
0674111435	STILO L-IP20 35W. A.F.	EXCLUSIVE	601,37 €	(8,5)	Reflector trasero	35 W.	STH	PG12-1
0674111450	STILO L-IP20 50W. A.F.	EXCLUSIVE	855,52 €	(8,5)	Reflector trasero	50 W.	STH	PG12-1
06741114100	STILO L-IP20 100W. A.F.	EXCLUSIVE	855,52 €	(8,5)	Reflector trasero	100 W.	STH	PG12-1
06741203132	STILO/F L-IP20 1x32W. H.F.	BASIC	593,33 €	(8,5)	Reflector facetado	32 W.	TC-TEL	GX24q
06741233132	STILO/F L-IP20 1x32W. H.F.	INDUSTRIAL	582,51 €	(8,5)	Reflector facetado	32 W.	TC-TEL	GX24q
06741203142	STILO/F L-IP20 1x42W. H.F.	BASIC	593,33 €	(8,5)	Reflector facetado	42 W.	TC-TEL	GX24q
06741233142	STILO/F L-IP20 1x42W. H.F.	INDUSTRIAL	582,51 €	(8,5)	Reflector facetado	42 W.	TC-TEL	GX24q
06741333132	STILO XL-IP20 1x32W. H.F.	INDUSTRIAL	681,06 €	(12,5)	Reflector liso	32 W.	TC-TEL	GX24q
06741333142	STILO XL-IP20 1x42W. H.F.	INDUSTRIAL	681,06 €	(12,5)	Reflector liso	42 W.	TC-TEL	GX24q
06741333157	STILO XL-IP20 1x57W. H.F.	INDUSTRIAL	718,63 €	(12,5)	Reflector liso	57 W.	TC-TEL	GX24q
06741335100	STILO XL-IP20 100W. A.F.	INDUSTRIAL	702,18 €	(12,5)	Reflector liso	100 W.	HIT	E27
06741335150	STILO XL-IP20 150W. A.F.	INDUSTRIAL	716,70 €	(12,5)	Reflector liso	150 W.	HIT	E27
06741335250	STILO XL-IP20 250W. A.F.	INDUSTRIAL	1.011,47 €	(12,5)	Reflector liso	250 W.	HIT	E40
067411031261	STILO L-IP40 1x26W. H.F.	BASIC	612,92 €	(8,5)	Reflector trasero	26 W.	TC-TEL	GX24q
067411131261	STILO L-IP40 1x26W. H.F.	EXCLUSIVE	657,12 €	(8,5)	Reflector trasero	26 W.	TC-TEL	GX24q
067411131321	STILO L-IP40 1x32W. H.F.	BASIC	612,92 €	(8,5)	Reflector trasero	32 W.	TC-TEL	GX24q
067411131321	STILO L-IP40 1x32W. H.F.	EXCLUSIVE	657,12 €	(8,5)	Reflector trasero	32 W.	TC-TEL	GX24q
067411131421	STILO L-IP40 1x42W. H.F.	BASIC	612,92 €	(8,5)	Reflector trasero	42 W.	TC-TEL	GX24q
067411131421	STILO L-IP40 1x42W. H.F.	EXCLUSIVE	657,12 €	(8,5)	Reflector trasero	42 W.	TC-TEL	GX24q
06741114351	STILO L-IP40 35W. A.F.	EXCLUSIVE	639,95 €	(8,5)	Reflector trasero	35 W.	STH	PG12-1
06741114501	STILO L-IP40 50W. A.F.	EXCLUSIVE	894,09 €	(8,5)	Reflector trasero	50 W.	STH	PG12-1
067411141001	STILO L-IP40 100W. A.F.	EXCLUSIVE	894,09 €	(8,5)	Reflector trasero	100 W.	STH	PG12-1
067412031321	STILO/F L-IP40 1x32W. H.F.	BASIC	631,90 €	(8,5)	Reflector facetado	32 W.	TC-TEL	GX24q
067412331321	STILO/F L-IP40 1x32W. H.F.	INDUSTRIAL	621,08 €	(8,5)	Reflector facetado	32 W.	TC-TEL	GX24q
067412031421	STILO/F L-IP40 1x42W. H.F.	BASIC	631,90 €	(8,5)	Reflector facetado	42 W.	TC-TEL	GX24q
067412331421	STILO/F L-IP40 1x42W. H.F.	INDUSTRIAL	621,08 €	(8,5)	Reflector facetado	42 W.	TC-TEL	GX24q
067413331321	STILO XL-IP40 1x32W. H.F.	INDUSTRIAL	722,45 €	(12,5)	Reflector liso	32 W.	TC-TEL	GX24q
067413331421	STILO XL-IP40 1x42W. H.F.	INDUSTRIAL	722,45 €	(12,5)	Reflector liso	42 W.	TC-TEL	GX24q
067413331571	STILO XL-IP40 1x57W. H.F.	INDUSTRIAL	760,02 €	(12,5)	Reflector liso	57 W.	TC-TEL	GX24q
067413351001	STILO XL-IP40 100W. A.F.	INDUSTRIAL	743,57 €	(12,5)	Reflector liso	100 W.	HIT	E27
067413351501	STILO XL-IP40 150W. A.F.	INDUSTRIAL	758,09 €	(12,5)	Reflector liso	150 W.	HIT	E27
067413352501	STILO XL-IP40 250W. A.F.	INDUSTRIAL	1.052,86 €	(12,5)	Reflector liso	250 W.	HIT	E40



Cadena de suspensión 1,4 mts incluida

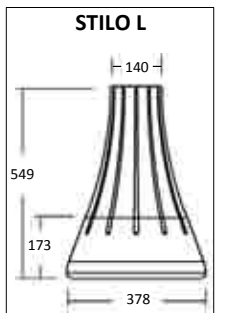

STILO L

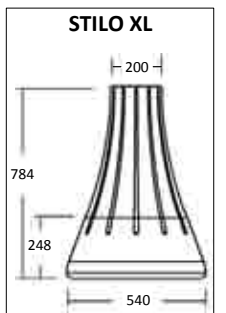

STILO XL

LUMINARIAS INDUSTRIALES



Materiales: Cuerpo en fundición de aluminio, reflector de policarbonato con baño de aluminio brillante, difusor de cristal templado.

CODIGO	REFERENCIA	Indice rendimiento de color CRI (Ra)	Temperatura de color CCT (k)	P.V.P. Kg.
IF1L099	ALUFORCE 99W. LED 8800lm/750	>70	5000	1.227,03 € (10,0)

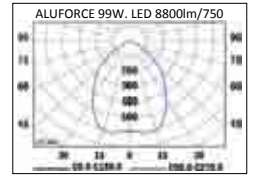

ACCESORIOS

1562003	SET DE SUSPENSION ALUFORCE (BAJO PEDIDO)			32,16 € ---
---------	---	--	--	--------------------



Superficie

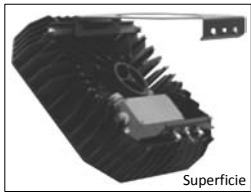

Superficie

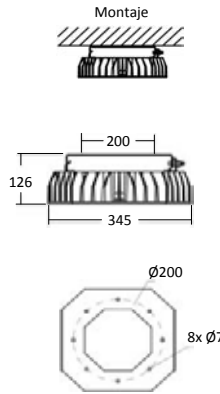

Montaje

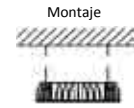

Montaje

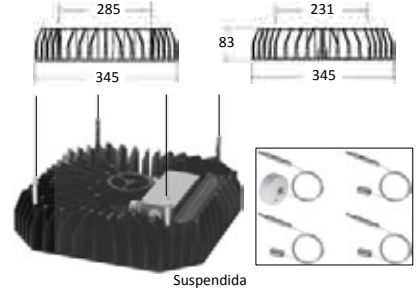

Suspendida

VERSION EMPOTRABLE

CODIGO	REFERENCIA	Indice rendimiento de color CRI (Ra)	Temperatura de color CCT (k)	P.V.P. Kg.
IF1L0991	ALUFORCE/E 99W. LED 8800lm/750	>70	5000	1.227,03 € (10,0)

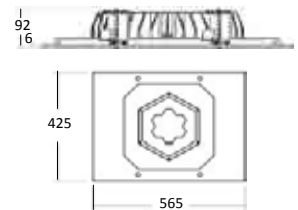
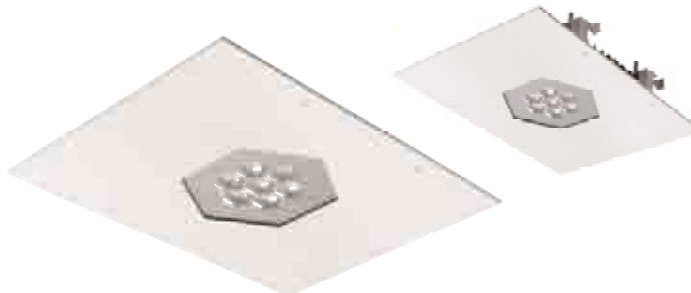
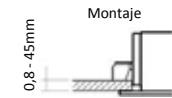
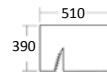

SUSPENDIDA DECORATIVA



Materiales: Cuerpo en acero, reflector de aluminio brillante

CODIGO	REFERENCIA	Indice rendimiento de color CRI (Ra)	Temperatura de color CCT (k)	P.V.P. Kg.
0674203113	AERO-1x13W. LED 1100lm/840	>80	4000	650,97 € (3,9)
0674203115	AERO-1x15W. LED 1100lm/830	>80	3000	650,97 € (3,9)
0674203126	AERO-1x26W. LED 2000lm/840	>80	4000	660,93 € (3,9)
0674203128	AERO-1x28W. LED 2000lm/830	>80	3000	660,93 € (3,9)
0674203146	AERO-1x46W. LED 2800lm/840	>80	4000	839,49 € (3,9)
0674203150	AERO-1x50W. LED 2800lm/830	>80	3000	839,49 € (3,9)

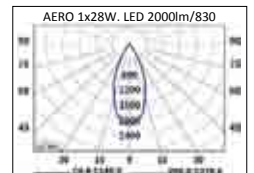

Acabado estándar en color gris RAL 9006 con efecto metálico, bajo consulta blanco RAL 9003.



Montaje

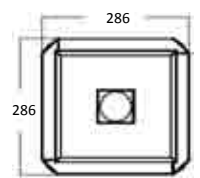
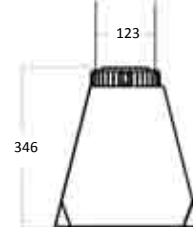

CAMPANAS INDUSTRIALES Y DECORATIVAS

Materiales: Base en aluminio inyectado, reflector de policarbonato, cierre de policarbonato.

CODIGO	REFERENCIA	P.V.P.	Kg.
06728001250	POLYMARKET-565-250W. VM a 230V.	247,97 €	(8,6)
06728001400	POLYMARKET-565-400W. VM a 230V.	261,25 €	(9,7)
06728002250	POLYMARKET-565-250W. HPS a 230V.	269,53 €	(9,7)
06728002400	POLYMARKET-565-400W. HPS a 230V.	281,84 €	(11,0)
06728003250	POLYMARKET-565-250W. HIT a 230V.	272,79 €	(9,8)
06728003250L	POLYMARKET-565-250W. HIT a 230V. con lámpara	321,44 €	(10,0)
06728003400	POLYMARKET-565-400W. HIT a 230V.	285,10 €	(11,1)
06728003400L	POLYMARKET-565-400W. HIT a 230V. con lámpara	333,75 €	(11,3)
06728004100L	POLYMARKET-565-100W. CFL H.F. con lámpara	341,34 €	(4,4)
06728004120L	POLYMARKET-565-120W. CFL H.F. con lámpara	472,48 €	(4,7)
06728004200L	POLYMARKET-565-200W. CFL H.F. con lámpara	530,80 €	(4,8)
06728004320L	POLYMARKET-565-320W. CFL H.F. con lámpara	725,15 €	(4,9)
El modelo POLYMARKET-565-100W. CFL H.F. incorpora lámpara fluorescente compacta integrada.			
06728000000	CUBIERTA POLYMARKET-565	38,19 €	---

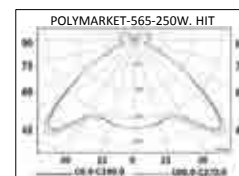
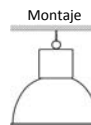

LOR= 89.63%

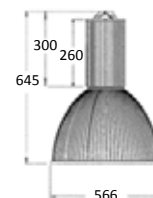

Materiales: Base en aluminio inyectado, reflector de policarbonato, cierre de policarbonato.

CODIGO	REFERENCIA	P.V.P.	Kg.
06729001250	POLYMARKET-410-250W. VM a 230V.	204,96 €	(7,7)
06729002250	POLYMARKET-410-250W. HPS a 230V.	226,52 €	(8,8)
06729003250	POLYMARKET-410-250W. HIT a 230V.	229,77 €	(8,8)
06729003250L	POLYMARKET-410-250W. HIT a 230V. con lámpara	278,42 €	(10,0)
06729004100L	POLYMARKET-410-100W. CFL H.F. con lámpara	298,33 €	(3,4)
06729004120L	POLYMARKET-410-120W. CFL H.F. con lámpara	429,46 €	(3,7)
06729004200L	POLYMARKET-410-200W. CFL H.F. con lámpara	487,79 €	(3,8)
El modelo POLYMARKET-410-100W. CFL H.F. incorpora lámpara fluorescente compacta integrada.			
06729000000	CUBIERTA POLYMARKET-410	27,42 €	---

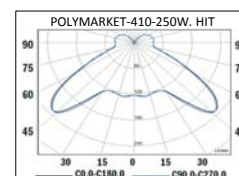
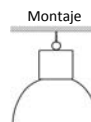

LOR= 89.56%

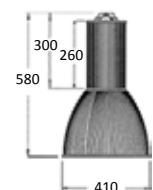

Materiales: Base en aluminio inyectado, reflector de policarbonato, cierre de policarbonato.

CODIGO	REFERENCIA	P.V.P.	Kg.
06729100001	POLYDECOR-410/E27 a 230V.	117,38 €	(3,6)
06729101050	POLYDECOR-410/E27-50W. VM a 230V.	167,48 €	(4,9)
06729101080	POLYDECOR-410/E27-80W. VM a 230V.	167,48 €	(4,9)
06729101125	POLYDECOR-410/E27-125W. VM a 230V.	170,30 €	(5,4)
06729102050	POLYDECOR-410/E27-50W. HPS a 230V.	178,74 €	(4,9)
06729102070	POLYDECOR-410/E27-70W. HPS a 230V.	182,56 €	(4,9)
06729103070	POLYDECOR-410/E27-70W. HIT a 230V.	182,56 €	(4,9)
06729103100	POLYDECOR-410/E27-100W. HIT a 230V.	185,50 €	(4,9)
06729103150	POLYDECOR-410/E27-150W. HIT a 230V.	195,42 €	(6,3)
06729100000	CUBIERTA POLYDECOR-410/E27	27,42 €	---

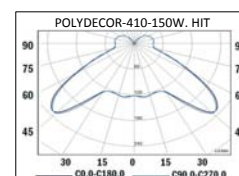
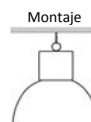
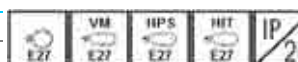

LOR= 89.56%



06729100002	CABLE 2 Mts. MAXIMO + SOPORTE BASE	30,97 €	---
-------------	------------------------------------	---------	-----



CAMPANAS INDUSTRIALES Y DECORATIVAS

Materiales: Base en policarbonato, reflector de policarbonato, cierre cristal opalino.

CODIGO	REFERENCIA	P.V.P.	Kg.	HIT	IP
06730033070	POLYTOP-415/IP44/G12 70W. HIT a 230V. + CRISTAL FILTRO	177,91 €	(4,4)	G12	44
06730033150	POLYTOP-415/IP44/G12 150W. HIT a 230V. + CRISTAL	190,78 €	(5,3)		
06730030	CADENA DE SUSPENSION 1,5 Mts.	20,00 €	---		
06729100002	CABLE 2 Mts. MAXIMO + SOPORTE BASE	30,97 €	---		

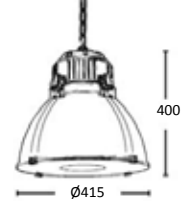
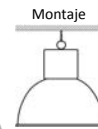

Materiales: Base en aluminio inyectado, reflector de aluminio brillo satinado, cierre de cristal transparente.

CODIGO	REFERENCIA	P.V.P.	Kg.	VM	HPS	HIT	CFL	IP
06731001250	ALUDECOR/BA-462/E40-250W. VM a 230V. + CRISTAL	288,54 €	(9,3)	E40	E40	E40	E40	20
06731001400	ALUDECOR/BA-462/E40-400W. VM a 230V. + CRISTAL	302,21 €	(10,5)					
06731002250	ALUDECOR/BA-462/E40-250W. HPS a 230V. + CRISTAL	310,74 €	(10,4)					
06731002400	ALUDECOR/BA-462/E40-400W. HPS a 230V. + CRISTAL	323,41 €	(11,8)					
06731003250	ALUDECOR/BA-462/E40-250W. HIT a 230V. + CRISTAL	314,09 €	(10,4)					
06731003250L	ALUDECOR/BA-462/E40-250W. HIT a 230V. con lámpara + CRISTAL	362,74 €	(10,6)					
06731003400	ALUDECOR/BA-462/E40-400W. HIT a 230V. + CRISTAL	326,77 €	(11,8)					
06731003400L	ALUDECOR/BA-462/E40-400W. HIT a 230V. con lámpara + CRISTAL	375,42 €	(12,0)					
06731004100	ALUDECOR/BA-462/E40-100W. CFL H.F. con lámpara + CRISTAL	384,66 €	(5,1)					
06731004120	ALUDECOR/BA-462/E40-120W. CFL H.F. con lámpara + CRISTAL	519,65 €	(5,4)					
06731004200	ALUDECOR/BA-462/E40-200W. CFL H.F. con lámpara + CRISTAL	579,70 €	(5,5)					
06731004320	ALUDECOR/BA-462/E40-320W. CFL H.F. con lámpara + CRISTAL	657,34 €	(5,6)					

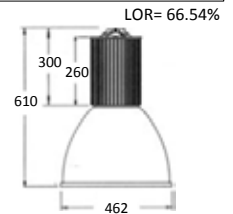
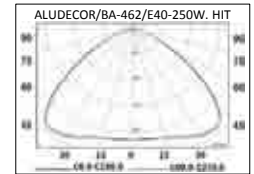
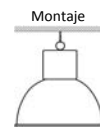

El modelo ALUDECOR/BA-462/E40-100W. CFL H.F. incorpora lámpara fluorescente compacta integrada.

Materiales: Base en aluminio inyectado, reflector de aluminio brillo satinado, cierre de cristal opal.

CODIGO	REFERENCIA	P.V.P.	Kg.	HIT	IP
06732003070	ALUDECOR/BR-462/G12-70W. HIT a 230V. + CRISTAL OPAL	202,49 €	(6,9)	G12	20
06732003150	ALUDECOR/BR-462/G12-150W. HIT a 230V. + CRISTAL OPAL	214,79 €	(7,8)		

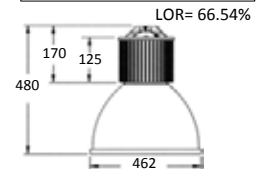
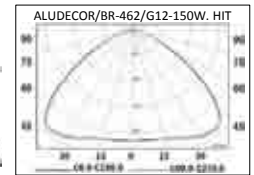
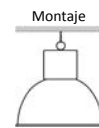
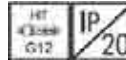

Materiales: Base en fibra de vidrio y poliamida reforzada, reflector de aluminio brillante, cierre de cristal transparente.

CODIGO	REFERENCIA	P.V.P.	Kg.	HIT	IP
06720322501L	OBL-480-IP65-250W. HIT a 230V. con lámpara+ CRISTAL	323,43 €	(9,1)	G12	65
06720324001L	OBL-480-IP65-400W. HIT a 230V. con lámpara+ CRISTAL	349,42 €	(10,2)		

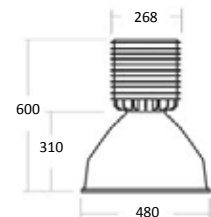
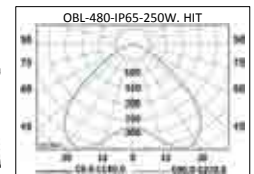
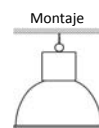
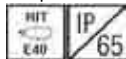

Rejilla de protección OBL-480-IP65 bajo consulta.

06720422501L	OBL/F-480-IP65-250W. HIT a 230V. con lámpara+ CRISTAL	323,43 €	(9,1)		
06720424001L	OBL/F-480-IP65-400W. HIT a 230V. con lámpara+ CRISTAL	349,42 €	(10,2)		

Rejilla de protección OBL/F-480-IP65 bajo consulta.



06729100002	CABLE 2 Mts. MAXIMO + SOPORTE BASE	30,97 €	---		
-------------	------------------------------------	---------	-----	--	--

CAMPANAS INDUSTRIALES

Materiales: Base en aluminio inyectado, reflector de aluminio facetado abrillantado, cierre cristal transparente.

CODIGO	REFERENCIA	P.V.P.	Kg.
06720222501	PGL/FA-IP65-250W. VM a 230V. + CRISTAL	184,56 €	(8,9)
06720224001	PGL/FA-IP65-400W. VM a 230V. + CRISTAL	199,07 €	(9,9)
06720232501	PGL/FA-IP65-250W. HPS a 230V. + CRISTAL	208,14 €	(10,0)
06720234001	PGL/FA-IP65-400W. HPS a 230V. + CRISTAL	221,60 €	(11,3)
06720212501	PGL/FA-IP65-250W. HIT a 230V. + CRISTAL	211,70 €	(10,1)
06720212501L	PGL/FA-IP65-250W. HIT a 230V. con lámpara + CRISTAL	260,35 €	(10,3)
06720214001	PGL/FA-IP65-400W. HIT a 230V. + CRISTAL	225,16 €	(11,2)
06720214001L	PGL/FA-IP65-400W. HIT a 230V. con lámpara + CRISTAL	273,81 €	(11,4)
06720241001L	PGL/FA-IP65-100W. CFL H.F. con lámpara + CRISTAL	286,68 €	(6,0)
06720241201L	PGL/FA-IP65-120W. CFL H.F. con lámpara + CRISTAL	430,11 €	(6,3)
06720242001L	PGL/FA-IP65-200W. CFL H.F. con lámpara + CRISTAL	493,90 €	(6,4)
06720243201L	PGL/FA-IP65-320W. CFL H.F. con lámpara + CRISTAL	576,40 €	(6,5)
067232	REJILLA DE SEGURIDAD PGL/FA-IP65	67,26 €	---

El modelo PGL/FA-IP65-100W. CFL H.F. incorpora lámpara fluorescente compacta integrada.

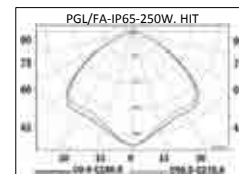
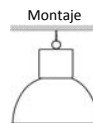

LOR= 70.33%

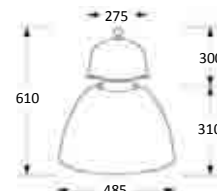

Materiales: Base en aluminio inyectado, reflector de aluminio abrillantado, cierre cristal transparente.

CODIGO	REFERENCIA	P.V.P.	Kg.
06720522501	PGL/C-IP65-250W. VM a 230V. + CRISTAL	184,56 €	(8,9)
06720524001	PGL/C-IP65-400W. VM a 230V. + CRISTAL	199,07 €	(9,9)
06720532501	PGL/C-IP65-250W. HPS a 230V. + CRISTAL	208,14 €	(10,0)
06720534001	PGL/C-IP65-400W. HPS a 230V. + CRISTAL	221,60 €	(11,3)
06720512501	PGL/C-IP65-250W. HIT a 230V. + CRISTAL	211,70 €	(10,1)
06720512501L	PGL/C-IP65-250W. HIT a 230V. con lámpara + CRISTAL	260,35 €	(10,3)
06720514001	PGL/C-IP65-400W. HIT a 230V. + CRISTAL	225,16 €	(11,2)
06720514001L	PGL/C-IP65-400W. HIT a 230V. con lámpara + CRISTAL	273,81 €	(11,4)

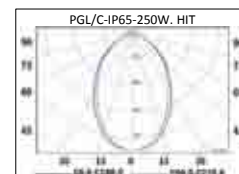
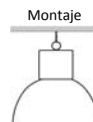
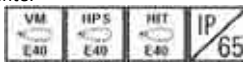

LOR= 66.47%

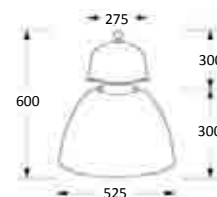

Materiales: Base en aluminio inyectado, reflector de aluminio abrillantado, cierre cristal transparente.

CODIGO	REFERENCIA	P.V.P.	Kg.
06720122501	PGL/C-IP54-250W. VM a 230V. + CRISTAL	181,67 €	(8,9)
06720124001	PGL/C-IP54-400W. VM a 230V. + CRISTAL	196,19 €	(9,9)
06720132501	PGL/C-IP54-250W. HPS a 230V. + CRISTAL	205,25 €	(10,0)
06720134001	PGL/C-IP54-400W. HPS a 230V. + CRISTAL	218,72 €	(11,3)
06720112501	PGL/C-IP54-250W. HIT a 230V. + CRISTAL	208,82 €	(10,1)
06720112501L	PGL/C-IP54-250W. HIT a 230V. con lámpara + CRISTAL	257,47 €	(10,3)
06720114001	PGL/C-IP54-400W. HIT a 230V. + CRISTAL	222,28 €	(11,2)
06720114001L	PGL/C-IP54-400W. HIT a 230V. con lámpara + CRISTAL	270,93 €	(11,4)

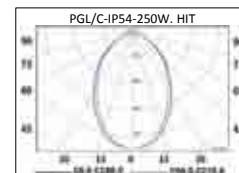
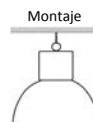

LOR= 66.47%

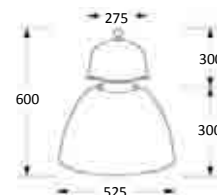

Materiales: Base en aluminio inyectado, reflector de aluminio abrillantado, cierre cristal transparente.

CODIGO	REFERENCIA	P.V.P.	Kg.
06720122501	PGF/C-250W. VM a 230V. + CRISTAL	150,86 €	(8,8)
06720124001	PGF/C-400W. VM a 230V. + CRISTAL	164,14 €	(9,8)
06720132501	PGF/C-250W. HPS a 230V. + CRISTAL	172,42 €	(9,9)
06720134001	PGF/C-400W. HPS a 230V. + CRISTAL	184,73 €	(11,2)
06720112501	PGF/C-250W. HIT a 230V. + CRISTAL	175,68 €	(10,0)
06720112501L	PGF/C-250W. HIT a 230V. con lámpara + CRISTAL	224,33 €	(10,2)
06720114001	PGF/C-400W. HIT a 230V. + CRISTAL	187,99 €	(11,1)
06720114001L	PGF/C-400W. HIT a 230V. con lámpara + CRISTAL	236,64 €	(11,3)
06720141001L	PGF/C-100W. CFL H.F. con lámpara + CRISTAL	244,23 €	(5,9)
06720141201L	PGF/C-120W. CFL H.F. con lámpara + CRISTAL	375,37 €	(6,2)
06720142001L	PGF/C-200W. CFL H.F. con lámpara + CRISTAL	433,70 €	(6,3)
06720143201L	PGF/C-320W. CFL H.F. con lámpara + CRISTAL	509,12 €	(6,4)
0672311	CRISTAL Y ACCESORIOS	16,06 €	---

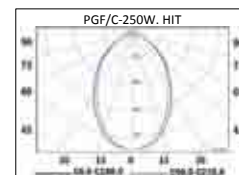
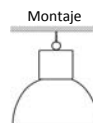

LOR= 66.47%

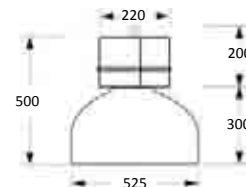

El modelo PGF/C-100W. CFL H.F. incorpora lámpara fluorescente compacta integrada.

ESTANCAS IP65 CON TUBOS

Materiales: Cuerpo en ABS reforzado estable, difusor de poliestireno inyectado, reflector de chapa de acero pintado en blanco.

CODIGO	REFERENCIA	Temperatura de color	Flujo luminoso	P.V.P.	Kg.
0123920L111L	ONIX/N-LED-1x10W/84	4000K	750Lm	104,95 €	(0,8)
0123920L122L	ONIX/N-LED-1x19W/84	4000K	1500Lm	150,41 €	(1,6)
0123920L125L	ONIX/N-LED-1x24W/84	4000K	1900Lm	197,27 €	(2,1)
0123920L134L	ONIX/N-LED-1x34W/84	4000K	3000Lm	248,24 €	(2,1)
0123920L211L	ONIX/N-LED-2x10W/84	4000K	1500Lm	187,43 €	(1,3)
0123920L222L	ONIX/N-LED-2x19W/84	4000K	3000Lm	287,26 €	(2,2)
0123920L225L	ONIX/N-LED-2x24W/84	4000K	3800Lm	378,05 €	(3,1)
0123920L234L	ONIX/N-LED-2x34W/84	4000K	6000Lm	479,98 €	(3,1)

Tubos LED Philips incluidos.

Sistema de suspensión por abrazaderas incluido.

Con cierres de acero inoxidable: Consultar precio.

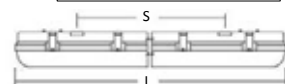
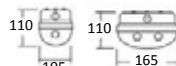

ESTANCAS IP65

Materiales: Cuerpo en ABS reforzado estable, difusor de poliestireno inyectado, reflector de chapa de acero pintado en blanco.

CODIGO	REFERENCIA	P.V.P.	Kg.
01239301236	ONIX/N-236 (2x36W.) 230V. B.F.	51,13 €	(4,4)
01239301258	ONIX/N-258 (2x58W.) 230V. B.F.	64,37 €	(7,4)
01239302118	ONIX/N-118 (1x18W.) 230V. A.F.	38,18 €	(2,0)
01239302136	ONIX/N-136 (1x36W.) 230V. A.F.	39,39 €	(3,5)
01239302158	ONIX/N-158 (1x58W.) 230V. A.F.	51,13 €	(4,5)
01239302218	ONIX/N-218 (2x18W.) 230V. A.F.	42,37 €	(2,6)
01239302236	ONIX/N-236 (2x36W.) 230V. A.F.	52,89 €	(4,5)
01239302258	ONIX/N-258 (2x58W.) 230V. A.F.	67,58 €	(7,5)
01239303118	ONIX/N-118 (1x18W.) H.F.	49,96 €	(1,7)
01239303136	ONIX/N-136 (1x36W.) H.F.	53,09 €	(3,0)
01239303158	ONIX/N-158 (1x58W.) H.F.	63,23 €	(3,5)
01239303218	ONIX/N-218 (2x18W.) H.F.	61,03 €	(2,0)
01239303236	ONIX/N-236 (2x36W.) H.F.	75,83 €	(4,0)
01239303258	ONIX/N-258 (2x58W.) H.F.	83,01 €	(5,8)

Sistema de suspensión por abrazaderas incluido.

Con cierres de acero inoxidable: Consultar precio.

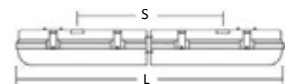
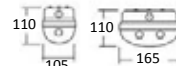

Materiales: Cuerpo en ABS reforzado estable, difusor de policarbonato inyectado, reflector de chapa de acero pintado en blanco.

CODIGO	REFERENCIA	P.V.P.	Kg.
01237302118	JADE/N-118 (1x18W.) 230V. A.F.	40,84 €	(2,0)
01237302136	JADE/N-136 (1x36W.) 230V. A.F.	42,11 €	(3,5)
01237302158	JADE/N-158 (1x58W.) 230V. A.F.	58,74 €	(4,5)
01237302218	JADE/N-218 (2x18W.) 230V. A.F.	47,42 €	(2,6)
01237302236	JADE/N-236 (2x36W.) 230V. A.F.	57,50 €	(4,5)
01237302258	JADE/N-258 (2x58W.) 230V. A.F.	80,97 €	(7,5)
01237303118	JADE/N-118 (1x18W.) H.F.	50,65 €	(1,7)
01237303136	JADE/N-136 (1x36W.) H.F.	58,58 €	(3,0)
01237303158	JADE/N-158 (1x58W.) H.F.	67,93 €	(3,5)
01237303218	JADE/N-218 (2x18W.) H.F.	62,22 €	(2,0)
01237303236	JADE/N-236 (2x36W.) H.F.	80,64 €	(4,0)
01237303258	JADE/N-258 (2x58W.) H.F.	95,52 €	(5,8)

Sistema de suspensión por abrazaderas incluido.

Con cierres de acero inoxidable: Consultar precio.



ESTANCAS IP65

Materiales: Cuerpo ultracompacto en ABS reforzado estable, difusor de policarbonato inyectado, reflector de chapa de acero pintado en blanco.

CODIGO	REFERENCIA	P.V.P.	Kg.
01237013114	T5/RPC-114 (1x14W.) H.F.	42,95 €	(0,8)
01237013124	T5/RPC-124 (1x24W.) H.F.	50,57 €	(0,8)
01237013128	T5/RPC-128 (1x28W.) H.F.	64,76 €	(1,6)
01237013154	T5/RPC-154 (1x54W.) H.F.	64,76 €	(1,6)
01237013135	T5/RPC-135 (1x35W.) H.F.	75,27 €	(2,2)
01237013149	T5/RPC-149 (1x49W.) H.F.	75,27 €	(2,2)
01237013180	T5/RPC-180 (1x80W.) H.F.	79,39 €	(2,2)
01237013228	T5/RPC-228 (2x28W.) H.F.	78,86 €	(2,2)
01237013254	T5/RPC-254 (2x54W.) H.F.	78,86 €	(2,2)
01237013235	T5/RPC-235 (2x35W.) H.F.	88,10 €	(2,9)
01237013249	T5/RPC-249 (2x49W.) H.F.	88,10 €	(2,9)

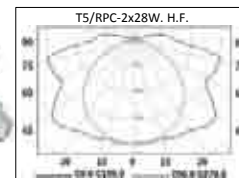

LOR= 85.70%

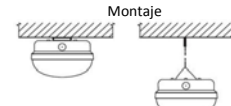

Dimensiones muy reducidas



114/128W. - L= 610, S=372
128/154/228/254W. - L=1210, S=860
135/149/180/235/249/280W. - L=1510, S=955

Sistema de suspensión por abrazaderas incluido.

Con cierres de acero inoxidable incluidos.

Materiales: Cuerpo en policarbonato, difusor de policarbonato inyectado, reflector de chapa de acero pintado en blanco.

CODIGO	REFERENCIA	P.V.P.	Kg.
019373280	TOP-280 (2x80W.) H.F.	119,56 €	(2,5)

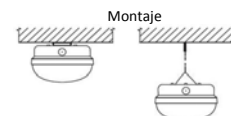

Con cierres de acero inoxidable: consultar precio.

ESTANCAS METALICAS IP65 CON TUBOS LED PHILIPS

Materiales: Cuerpo en acero inoxidable 18/8 (0,7mm espesor), difusor de cristal templado, reflector de chapa de acero pintado en blanco.

CODIGO	REFERENCIA	Temperatura de color	Flujo luminoso	P.V.P.	Kg.
0123800111L	ACERO-LED-1x10W/84	4000K	750Lm	223,32 €	(2,4)
0123800122L	ACERO-LED-1x19W/84	4000K	1500Lm	311,04 €	(4,8)
0123800125L	ACERO-LED-1x24W/84	4000K	1900Lm	381,15 €	(4,7)
0123800134L	ACERO-LED-1x34W/84	4000K	3000Lm	432,12 €	(4,7)
0123800211L	ACERO-LED-2x10W/84	4000K	1500Lm	334,52 €	(3,5)
0123800222L	ACERO-LED-2x19W/84	4000K	3000Lm	464,05 €	(6,3)
0123800225L	ACERO-LED-2x24W/84	4000K	3800Lm	588,91 €	(7,5)
0123800234L	ACERO-LED-2x34W/84	4000K	6000Lm	690,84 €	(7,5)



1x10/2x10W. - L= 705, S= 500
1x19/2x19W. - L=1305, S=1100
1x24/1x34/2x24/2x34W. - L=1605, S=1400

Tubos LED Philips incluidos.

Con cáncamos y cierres de acero inoxidable incluidos.



Cáncamo y cierres inox.

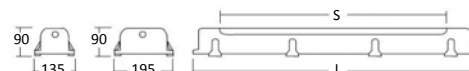

ESTANCAS METALICAS IP65

Materiales: Cuerpo en acero inoxidable 18/8 (0,7mm espesor), difusor de cristal templado, reflector de chapa de acero pintado en blanco.

CODIGO	REFERENCIA	P.V.P.	Kg.
01238003118	ACERO-1x18W. H.F.	157,11 €	(3,8)
01238003136	ACERO-1x36W. H.F.	210,33 €	(5,2)
01238003158	ACERO-1x58W. H.F.	246,58 €	(6,2)
01238003218	ACERO-2x18W. H.F.	192,83 €	(4,9)
01238003236	ACERO-2x36W. H.F.	246,17 €	(6,0)
01238003258	ACERO-2x58W. H.F.	300,19 €	(9,0)

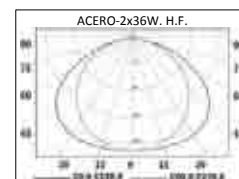
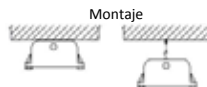

LOR= 53.40%

Con cáncamos y cierres de acero inoxidable incluidos.

01238003114	ACERO-1x14W. H.F.	158,60 €	(3,8)
01238003124	ACERO-1x24W. H.F.	158,60 €	(3,8)
01238003128	ACERO-1x28W. H.F.	210,32 €	(5,2)
01238003154	ACERO-1x54W. H.F.	210,32 €	(5,2)
01238003135	ACERO-1x35W. H.F.	247,19 €	(6,2)
01238003149	ACERO-1x49W. H.F.	247,19 €	(6,2)
01238003180	ACERO-1x80W. H.F.	252,78 €	(6,2)
01238003214	ACERO-2x14W. H.F.	196,07 €	(4,9)
01238003224	ACERO-2x24W. H.F.	196,07 €	(4,9)
01238003228	ACERO-2x28W. H.F.	248,07 €	(6,0)
01238003254	ACERO-2x54W. H.F.	248,07 €	(6,0)
01238003235	ACERO-2x35W. H.F.	300,12 €	(9,0)
01238003249	ACERO-2x49W. H.F.	300,12 €	(9,0)
01238003280	ACERO-2x80W. H.F.	304,94 €	(9,0)



118/218W. - L= 705, S= 500
136/236W. - L=1305, S=1100
158/258W. - L=1605, S=1400

Con cáncamos y cierres de acero inoxidable incluidos.

GRANDES POTENCIAS

01238003195	ACERO-1x95W. H.F.	352,73 €	(9,0)
012380031120	ACERO-1x120W. H.F.	352,73 €	(9,0)
012380031295	ACERO-2x95W. H.F.	439,07 €	(9,0)

Con cáncamos y cierres de acero inoxidable incluidos.



Cáncamo y cierres inox.

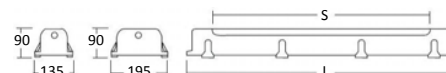

ESTANCAS BAJAS TEMPERATURAS

Materiales: Cuerpo en policarbonato bicolor de 1 mm de espesor, tapas finales de ABS, reflector aluminio brillante.

CODIGO	REFERENCIA	P.V.P.	Kg.
010383118	FR-IP67-1x18W. H.F.	125,41 €	(0,8)
010383136	FR-IP67-1x36W. H.F.	156,62 €	(1,1)
010383158	FR-IP67-1x58W. H.F.	167,74 €	(1,2)
010383218	FR-IP67-2x18W. H.F.	140,71 €	(0,8)
010383236	FR-IP67-2x36W. H.F.	164,98 €	(1,1)
010383258	FR-IP67-2x58W. H.F.	177,36 €	(1,2)
010383114	FR-IP67-1x14W. H.F.	137,78 €	(0,7)
010383124	FR-IP67-1x24W. H.F.	137,78 €	(0,7)
010383128	FR-IP67-1x28W. H.F.	161,83 €	(1,0)
010383154	FR-IP67-1x54W. H.F.	161,83 €	(1,0)
010383135	FR-IP67-1x35W. H.F.	173,45 €	(1,2)
010383149	FR-IP67-1x49W. H.F.	173,45 €	(1,2)
010383180	FR-IP67-1x80W. H.F.	178,36 €	(1,2)
010383214	FR-IP67-2x14W. H.F.	154,14 €	(0,8)
010383224	FR-IP67-2x24W. H.F.	154,14 €	(0,7)
010383228	FR-IP67-2x28W. H.F.	177,26 €	(1,0)
010383254	FR-IP67-2x54W. H.F.	177,26 €	(1,0)
010383235	FR-IP67-2x35W. H.F.	192,92 €	(1,2)
010383249	FR-IP67-2x49W. H.F.	192,92 €	(1,2)

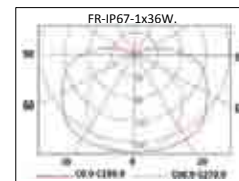
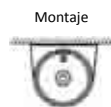

1x18/2x18W. - L= 713
 1x36/2x36W. - L=1323
 1x58/2x58W. - L=1628
 1x14/1x24/2x14/2x24W. - L= 675
 1x28/2x28/1x54/2x54W. - L=1276
 1x35/1x49/1x80/2x35/2x49/2x80W. - L=1578

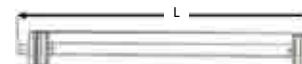

Temperatura de trabajo: de -15°C a +55°C

Version "muy bajas temperaturas" de -40°C a 0°C, bajo consulta.

ESTANCAS TUNELES

Materiales: Cuerpo en policarbonato M1 anti U-V de 2 mm de espesor, tapas finales de policarbonato, reflector aluminio brillante.

CODIGO	REFERENCIA	P.V.P.	Kg.
010393114	TN-IP68-1x14W. H.F.	502,99 €	(0,8)
010393124	TN-IP68-1x24W. H.F.	502,99 €	(0,8)
010393128	TN-IP68-1x28W. H.F.	607,74 €	(1,1)
010393154	TN-IP68-1x54W. H.F.	607,74 €	(1,1)
010393135	TN-IP68-1x35W. H.F.	640,88 €	(1,3)
010393149	TN-IP68-1x49W. H.F.	640,88 €	(1,3)
010393180	TN-IP68-1x80W. H.F.	657,20 €	(1,3)
010393214	TN-IP68-2x14W. H.F.	705,79 €	(0,8)
010393224	TN-IP68-2x24W. H.F.	705,79 €	(0,8)
010393228	TN-IP68-2x28W. H.F.	829,29 €	(1,1)
010393254	TN-IP68-2x54W. H.F.	829,29 €	(1,1)
010393235	TN-IP68-2x35W. H.F.	859,94 €	(1,3)
010393249	TN-IP68-2x49W. H.F.	859,94 €	(1,3)

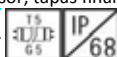

1x14/124/214/2x24W. - L= 675
 1x28/2x28/1x54/2x54W. - L=1276
 1x35/1x49/1x80/2x35/2x49/2x80W. - L=1578



Sistema de sujeción por bridas incluido.

Temperatura de trabajo: de -15°C a +55°C

REGLETAS INDUSTRIALES

Materiales: Cuerpo en chapa de acero blanca, reflector de aluminio brillante.

CODIGO	REFERENCIA	P.V.P.	Kg.
100212240	PI/FA-2x36W. a 230V. A.F.	78,31 €	(2,6)
100212340	PI/FA-3x36W. a 230V. A.F.	97,50 €	(3,2)
100212265	PI/FA-2x58W. a 230V. A.F.	103,61 €	(3,5)
100212365	PI/FA-3x58W. a 230V. A.F.	125,50 €	(4,3)
100213240	PI/FA-2x36W. H.F.	92,11 €	(1,6)
100213340	PI/FA-3x36W. H.F.	118,62 €	(1,6)
100213265	PI/FA-2x58W. H.F.	108,97 €	(1,8)
100213365	PI/FA-3x58W. H.F.	145,66 €	(1,9)
100213280	PI/FA-2x80W. H.F.	130,44 €	(1,8)
100213380	PI/FA-3x80W. H.F.	172,94 €	(1,9)

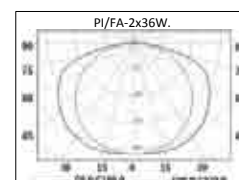
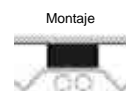

LOR= 75.07%

236/336W. - L=1233
 258/358/280/380/295/2120W. - L=1533

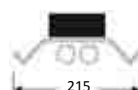

GRANDES POTENCIAS

100213295	PI/FA-2x95W. H.F.	169,29 €	(1,8)
100213210	PI/FA-2x120W. H.F.	169,29 €	(1,8)

Otros modelos T-5 bajo consulta.

Con reflector de aluminio lacado en blanco, mismo precio que brillante, referencia "PI/F".

REGLETAS ESTANCAS IP65

Materiales: Cuerpo en fibra de vidrio poliéster, sin tubo protector.

CODIGO	REFERENCIA	P.V.P.	Kg.
004262118	RET-1x18W. a 230V. A.F.	59,22 €	(1,7)
004262136	RET-1x36W. a 230V. A.F.	65,66 €	(2,1)
004262158	RET-1x58W. a 230V. A.F.	78,58 €	(2,7)
004262218	RET-2x18W. a 230V. A.F.	80,57 €	(2,3)
004262236	RET-2x36W. a 230V. A.F.	87,74 €	(2,7)
004262258	RET-2x58W. a 230V. A.F.	103,92 €	(3,6)
004263118	RET-1x18W. H.F.	78,85 €	(1,2)
004263136	RET-1x36W. H.F.	89,73 €	(1,6)
004263158	RET-1x58W. H.F.	99,34 €	(1,7)
004263218	RET-2x18W. H.F.	95,68 €	(1,3)
004263236	RET-2x36W. H.F.	104,15 €	(1,7)
004263258	RET-2x58W. H.F.	115,94 €	(1,8)
004263114	RET-1x14W. H.F.	84,44 €	(1,2)
004263124	RET-1x24W. H.F.	84,44 €	(1,2)
004263128	RET-1x28W. H.F.	93,25 €	(1,6)
004263154	RET-1x54W. H.F.	93,25 €	(1,6)
004263135	RET-1x35W. H.F.	104,47 €	(1,7)
004263149	RET-1x49W. H.F.	104,47 €	(1,7)
004263214	RET-2x14W. H.F.	101,52 €	(1,3)
004263224	RET-2x24W. H.F.	101,52 €	(1,3)
004263228	RET-2x28W. H.F.	114,11 €	(1,7)
004263254	RET-2x54W. H.F.	114,11 €	(1,7)
004263235	RET-2x35W. H.F.	124,12 €	(1,8)
004263249	RET-2x49W. H.F.	124,12 €	(1,8)

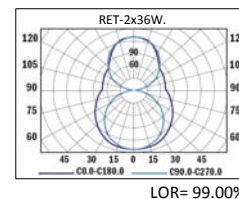
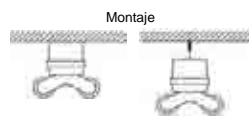

118/218W. - L= 661, Y=320
 136/236W. - L=1271, Y=900
 158/258W. - L=1571, Y=900
 114/124/214/224W. - L= 661, Y=320
 128/154/228/254W. - L=1271, Y=900
 135/149/235/249W. - L=1571, Y=900

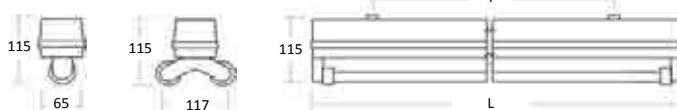

Materiales: Cuerpo en fibra de vidrio poliéster, con tubo protector.

CODIGO	REFERENCIA	P.V.P.	Kg.
004272118	RET/P-1x18W. a 230V. A.F.	70,97 €	(2,3)
004272136	RET/P-1x36W. a 230V. A.F.	79,33 €	(2,7)
004272158	RET/P-1x58W. a 230V. A.F.	98,25 €	(3,6)
004272218	RET/P-2x18W. a 230V. A.F.	108,67 €	(3,4)
004272236	RET/P-2x36W. a 230V. A.F.	114,51 €	(3,8)
004272258	RET/P-2x58W. a 230V. A.F.	142,74 €	(5,1)
004273118	RET/P-1x18W. H.F.	91,88 €	(1,8)
004273136	RET/P-1x36W. H.F.	103,92 €	(2,2)
004273158	RET/P-1x58W. H.F.	119,01 €	(2,6)
004273218	RET/P-2x18W. H.F.	122,12 €	(2,4)
004273236	RET/P-2x36W. H.F.	132,00 €	(2,8)
004273258	RET/P-2x58W. H.F.	155,32 €	(3,3)
004273114	RET/P-1x14W. H.F.	93,77 €	(1,8)
004273124	RET/P-1x24W. H.F.	93,77 €	(1,8)
004273128	RET/P-1x28W. H.F.	119,23 €	(2,2)
004273154	RET/P-1x54W. H.F.	119,23 €	(2,2)
004273135	RET/P-1x35W. H.F.	131,13 €	(2,6)
004273149	RET/P-1x49W. H.F.	131,13 €	(2,6)
004273214	RET/P-2x14W. H.F.	123,00 €	(2,4)
004273224	RET/P-2x24W. H.F.	123,00 €	(2,4)
004273228	RET/P-2x28W. H.F.	164,03 €	(2,8)
004273254	RET/P-2x54W. H.F.	164,03 €	(2,8)
004273235	RET/P-2x35W. H.F.	174,04 €	(3,3)
004273249	RET/P-2x49W. H.F.	174,04 €	(3,3)

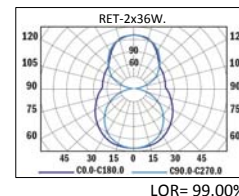
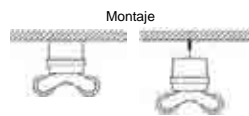

118/218W. - L= 661, Y=320
 136/236W. - L=1271, Y=900
 158/258W. - L=1571, Y=900
 114/124/214/224W. - L= 661, Y=320
 128/154/228/254W. - L=1271, Y=900
 135/149/235/249W. - L=1571, Y=900

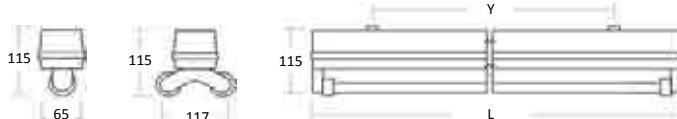

REGLETAS CON TUBOS LED PHILIPS

Materiales: Cuerpo en chapa de acero blanca laminada en frio.

CODIGO	REFERENCIA	Temperatura de color	Flujo luminoso	P.V.P.	Kg.
00420L111L	RT-LED-1x10W/84	4000K	750Lm	98,12 €	(0,5)
00420L122L	RT-LED-1x19W/84	4000K	1500Lm	141,15 €	(0,9)
00420L125L	RT-LED-1x24W/84	4000K	1900Lm	186,13 €	(1,0)
00420L134L	RT-LED-1x34W/84	4000K	3000Lm	237,10 €	(1,0)
00420L211L	RTL-LED-2x10W/84	4000K	1500Lm	178,48 €	(0,5)
00420L222L	RTL-LED-2x19W/84	4000K	3000Lm	270,41 €	(0,9)
00420L225L	RTL-LED-2x24W/84	4000K	3800Lm	358,59 €	(1,0)
00420L234L	RTL-LED-2x34W/84	4000K	6000Lm	460,52 €	(1,0)

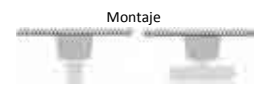

1x10/2x10W. - L= 624, E=405
 1x19/2x19W. - L=1233, E=405
 1x24/1x34/2x24/2x34W. - L=1534, E=405

Tubos LED Philips incluidos.

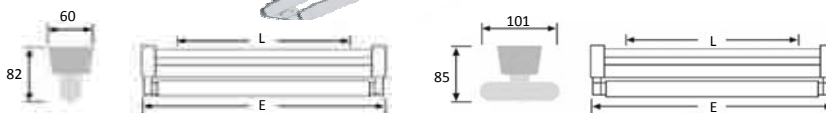

REGLETAS EXTRA PLANAS



Materiales: Cuerpo en aluminio, difusor de material termoplástico opalino, embalaje blister.

CODIGO	REFERENCIA	Índice rendimiento de color CRI (Ra)	Temperatura de color CCT (k)	P.V.P.	Kg.
RS1L475	SLIM-LED 475 - 6,7W. 420lm/730	>70	3000	88,34 €	(0,5)
RS1L625	SLIM-LED 625 - 8,4W. 550lm/730	>70	3000	105,27 €	(0,6)

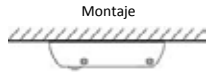

SLIM-LED 475 - L= 475
SLIM-LED 625 - L= 550

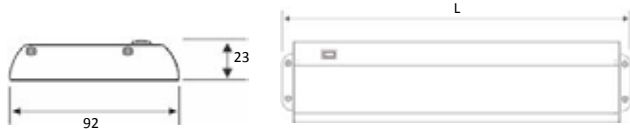

Materiales: Cuerpo en aluminio, difusor de material termoplástico opalino, embalaje blister.

CODIGO	REFERENCIA	Índice rendimiento de color CRI (Ra)	Temperatura de color CCT (k)	P.V.P.	Kg.
RT1L300	TLH-LED 300 - 2,3W. 154lm/730	>70	3000	44,68 €	(0,2)
RT1L540	TLH-LED 540 - 4,0W. 270lm/730	>70	3000	56,60 €	(0,3)
RT1L860	TLH-LED 860 - 6,2W. 424lm/730	>70	3000	75,79 €	(0,5)
RT1L0001	CONECTOR 500mm TLH	---	---	5,55 €	---



Luminaria preparada para montaje en líneas continuas.



TLH-LED 300 - L= 300
TLH-LED 540 - L= 540
TLH-LED 860 - L= 860



REGLETAS MINI

Materiales: Cuerpo en termoplástico autoextingible color blanco, difusor de metacrilato de metilo prismático transparente, embalaje blister.

CODIGO	REFERENCIA	Flujo Luminoso (lm)	Temperatura de color CCT (k)	P.V.P.	Kg.
0022513806	TKL-6 (6W.) + lámpara	280	3500	17,46 €	(0,3)
0022513808	TKL-8 (8W.) + lámpara	450	3500	17,81 €	(0,3)
0022513813	TKL-13 (13W.) + lámpara	800	3500	21,24 €	(0,4)
0022513818	TKL-18 (18W.) + lámpara	860	3500	28,52 €	(0,5)

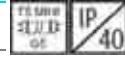

Accesorio para montaje en líneas continuas incluido, máximo 10 unidades.

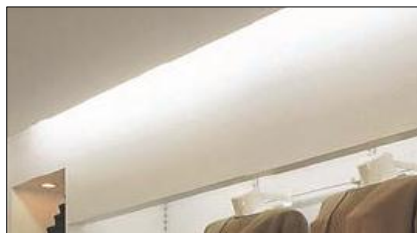

TKL-6 - L= 267
TKL-8 - L= 342
TKL-13 - L= 575
TKL-18 - L= 605



Materiales: Cuerpo en termoplástico autoextingible color blanco, difusor de metacrilato de metilo prismático opal.

CODIGO	REFERENCIA	Flujo Luminoso (lm)	Temperatura de color CCT (k)	P.V.P.	Kg.
0022610006	TB-6 (6W.) + lámpara	280	3500	18,58 €	(0,4)



Accesorio para montaje en líneas continuas bajo consulta.



REGLETAS Y REFLECTORES

Materiales: Chapa de acero blanca laminada en frio.

CODIGO	REFERENCIA	P.V.P.	Kg.
004201118	RT-1x18W. a 230V. B.F.	15,05 €	(0,9)
004201136	RT-1x36W. a 230V. B.F.	17,79 €	(1,3)
004201158	RT-1x58W. a 230V. B.F.	22,13 €	(1,9)
004201218	RT-2x18W. a 230V. B.F.	17,40 €	(1,3)
004201236	RT-2x36W. a 230V. B.F.	27,68 €	(1,9)
004201258	RT-2x58W. a 230V. B.F.	35,27 €	(2,7)
004202118	RT-1x18W. a 230V. A.F.	17,03 €	(1,0)
004202136	RT-1x36W. a 230V. A.F.	19,77 €	(1,3)
004202158	RT-1x58W. a 230V. A.F.	24,57 €	(1,9)
004202218	RT-2x18W. a 230V. A.F.	19,71 €	(1,3)
004202236	RT-2x36W. a 230V. A.F.	30,53 €	(1,9)
004202258	RT-2x58W. a 230V. A.F.	39,12 €	(2,8)
004203118	RT-1x18W. H.F.	42,24 €	(0,7)
004203136	RT-1x36W. H.F.	44,35 €	(0,8)
004203158	RT-1x58W. H.F.	45,80 €	(0,9)
004203218	RT-2x18W. H.F.	47,64 €	(0,8)
004203236	RT-2x36W. H.F.	51,01 €	(0,9)
004203258	RT-2x58W. H.F.	51,57 €	(1,0)

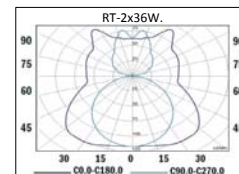
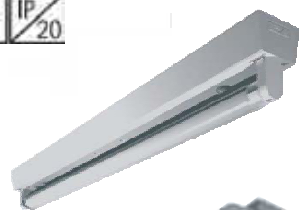

LOR= 80.62%

1x18/2x18W. - L= 624, Y=405
1x36/2x36W. - L=1233, Y=405
1x58/2x58W. - L=1534, Y=405



REFLECTORES

Materiales: Chapa de acero esmaltada en color blanco.

CODIGO	REFERENCIA	P.V.P.	Kg.
009211201	RT/P-1x18W.	9,40 €	---
009211401	RT/P-1x36W.	13,17 €	---
009211651	RT/P-1x58W.	15,85 €	---
009212201	RT/P-2x18W.	10,97 €	---
009212401	RT/P-2x36W.	16,22 €	---
009212651	RT/P-2x58W.	20,18 €	---



1x18/2x18W. - L= 624, Y=405
1x36/2x36W. - L=1233, Y=405
1x58/2x58W. - L=1534, Y=405

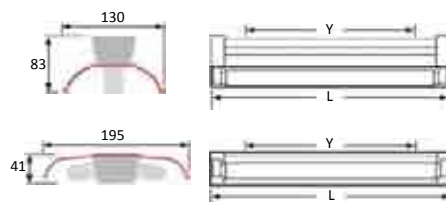

Materiales: Chapa de aluminio brillante.

CODIGO	REFERENCIA	P.V.P.	Kg.
009221201	RT/PAL-1x18W.	10,00 €	---
009221401	RT/PAL-1x36W.	17,68 €	---
009221651	RT/PAL-1x58W.	22,39 €	---
009222201	RT/PAL-2x18W.	12,98 €	---
009222401	RT/PAL-2x36W.	23,50 €	---
009222651	RT/PAL-2x58W.	28,87 €	---

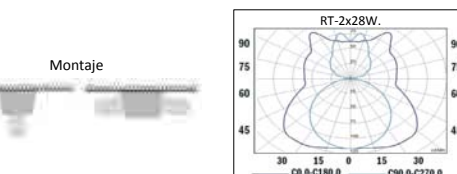

LOR= 80.62%

1x14/1x24/2x14/2x24W. - L= 598, Y=405
1x28/1x54/2x28/2x54/W. - L=1198, Y=405
1x35/1x49/1x80/2x35/2x49/2x80W. - L=1498, Y=405

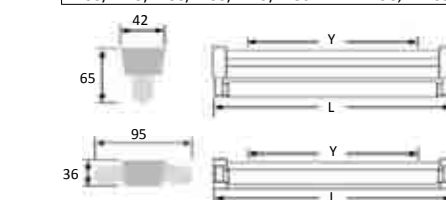

Materiales: Chapa de acero blanca laminada en frio.

CODIGO	REFERENCIA	P.V.P.	Kg.
004203114	RT-5/MINI-1x14W. H.F.	41,12 €	(0,7)
004203124	RT-5/MINI-1x24W. H.F.	44,03 €	(0,7)
004203128	RT-5/MINI-1x28W. H.F.	43,27 €	(0,8)
004203154	RT-5/MINI-1x54W. H.F.	43,27 €	(0,8)
004203135	RT-5/MINI-1x35W. H.F.	44,81 €	(0,9)
004203149	RT-5/MINI-1x49W. H.F.	44,81 €	(0,9)
004203180	RT-5/MINI-1x80W. H.F.	49,81 €	(0,9)
004203214	RT-5/MINI-2x14W. H.F.	47,05 €	(0,8)
004203224	RT-5/MINI-2x24W. H.F.	51,81 €	(0,8)
004203228	RT-5/MINI-2x28W. H.F.	49,25 €	(0,9)
004203254	RT-5/MINI-2x54W. H.F.	49,25 €	(0,9)
004203235	RT-5/MINI-2x35W. H.F.	50,06 €	(1,0)
004203249	RT-5/MINI-2x49W. H.F.	50,06 €	(1,0)
004203280	RT-5/MINI-2x80W. H.F.	80,95 €	(1,0)

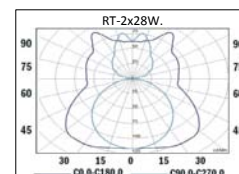
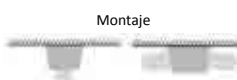

LOR= 80.62%

1x14/1x24/2x14/2x24W. - L= 598, Y=405
1x28/1x54/2x28/2x54/W. - L=1198, Y=405
1x35/1x49/1x80/2x35/2x49/2x80W. - L=1498, Y=405

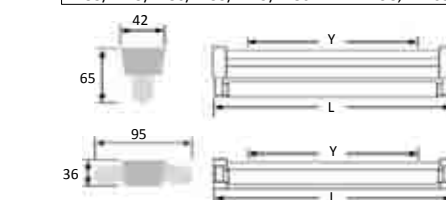

REFLECTORES

Materiales: Chapa de acero esmaltada en color blanco.

CODIGO	REFERENCIA	P.V.P.	Kg.
0092111424	RT-5/MINI/P-1x14/24W.	13,94 €	---
0092112854	RT-5/MINI/P-1x28/54W.	20,10 €	---
0092113580	RT-5/MINI/P-1x35/49/80W.	25,60 €	---
0092121424	RT-5/MINI/P-2x14/24W.	17,38 €	---
0092122854	RT-5/MINI/P-2x28/54W.	27,01 €	---
0092123580	RT-5/MINI/P-2x35/49/80W.	34,03 €	---



1x14/1x24/2x14/2x24W. - L= 598, Y=405
1x28/1x54/2x28/2x54/W. - L=1198, Y=405
1x35/1x49/1x80/2x35/2x49/2x80W. - L=1498, Y=405

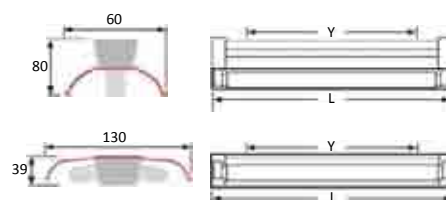

Materiales: Chapa de aluminio brillante.

CODIGO	REFERENCIA	P.V.P.	Kg.
0092211424	RT-5/MINI/PAL-1x14/24W.	13,78 €	---
0092212854	RT-5/MINI/PAL-1x28/54W.	25,57 €	---
0092213580	RT-5/MINI/PAL-1x35/49/80W.	31,99 €	---
0092221424	RT-5/MINI/PAL-2x14/24W.	20,20 €	---
0092222854	RT-5/MINI/PAL-2x28/54W.	34,13 €	---
0092223580	RT-5/MINI/PAL-2x35/49/80W.	42,83 €	---



CARRILES Y ACCESORIOS

Materiales: Carril en chapa de acero esmaltado en color blanco.

CODIGO	REFERENCIA	P.V.P.	Kg.
009231	C-258 (3070mm)	37,95 €	---
009238	UC (UNION CARRIL)	5,27 €	---
009236	TF (TAPA FINAL)	2,93 €	---
009235	SR (SOPORTE REGLETA)	2,58 €	---
009230104	TC (TAPA CIEGA 1 Mtr.)	6,06 €	---

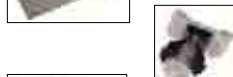
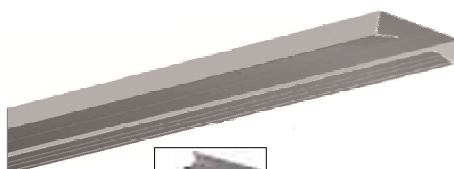

Materiales: Carril electrificado en chapa de acero esmaltado en color blanco.

CODIGO	REFERENCIA	P.V.P.	Kg.
009232	C-258-ELEC (3070mm, 3 P.)	111,75 €	---
009238	UC (UNION CARRIL)	5,27 €	---
009236	TF (TAPA FINAL)	2,93 €	---
009235	SR (SOPORTE REGLETA)	2,58 €	---
009230104	TC (TAPA CIEGA 1 Mtr.)	6,06 €	---
009252	CC-E (CONECTOR CARRIL 3 P.)	12,33 €	---

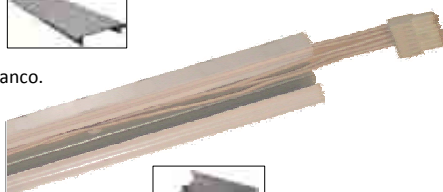

KITS DE EMERGENCIA MONTADOS EN LUMINARIAS

CODIGO	REFERENCIA	P.V.P.	Kg.
02020358	MC-1 (KIT DE EMERGENCIA DE 1h.)	143,92 €	---
020203583	MC-3 (KIT DE EMERGENCIA DE 3h.	180,03 €	---



ECORAE, por lámpara Compacta	0,20 "
ECORAE, por lámpara LED	0,20 "
ECORAE, por lámpara Fluorescente o Descarga	0,30 "
Aportación ECOPILAS por kit de Emergencia	0,12 "

Categorías ECORAE para luminarias:

Categoría A:	<750 gramos	0,25 "
Categoría B:	750 gramos - 5 Kg.	0,50 "
Categoría C:	> 5 Kg.	0,70 "
Categoría LED A:	<750 gramos	0,10 "
Categoría LED B:	750 gramos - 5 Kg.	0,10 "
Categoría LED C:	> 5 Kg.	0,60 "

DELEGACIONES:

MADRID Tel.: 916 620 071 • Fax: 916 611 219 • Móvil: 680 427 717

E-mail: ilopez@lux-may.com

VIZCAYA Tel.: 946 730 809 / 946 308 180 • Fax: 946 734 143

E-mails: comercial@lux-may.com

administracion@lux-may.com

calidad@lux-may.com

produccion@lux-may.com

proyectos@lux-may.com

CATALUÑA Tel.: 935 748 000 • Fax: 935 601 206 • Móvil: 607 503 010

E-mail: ramon@enlumenat.cat

ALICANTE Tel.: 965 101 924 • Fax: 965 288 635 • Móvil: 639 823 850

E-mail: moiseslopez@moiseslopez.es

ASTURIAS Tel.: 985 561 478 • Fax: 985 561 478 • Móvil: 617 420 481

E-mail: pendasjl@gmail.com

BALEARES Tel.: 971 280 150 • Fax: 971 739 880 • Móvil: 609 333 686

E-mail: bartigues@atlas.com.es

GALICIA Tel.: 986 460 661 • Fax: 986 460 661 • Móvil: 679 952 679

E-mail: nicolasonaindia@hotmail.es

JAEN Tel.: 953 280 677 • Fax: 953 280 537 • Móvil: 678 563 742

E-mail: inselenergy@inselenergy.es

MURCIA Tel.: 968 885 329 • Fax: 968 885 371 • Móvil: 609 657 133

E-mail: J_martinez@telefonica.net

SEVILLA Tel.: 954 008 101 • Fax: 954 008 101 • Móvil: 647 605 199

E-mail: capillasl@gmail.es

VALENCIA Fax: 961 481 231 • Móvil: 647 481 231

E-mail: jnebot@coacvalencia.es

VALLADOLID Móvil: 608 267 200

E-mail: angel-nunez@telefonica.net

CONDICIONES GENERALES DE VENTA

Nuestros envíos viajan por cuenta y riesgo del cliente, cualquiera que sea el sistema de expedición. En caso de avería, rotura o robo, durante el transporte, el cliente deberá realizar las reclamaciones pertinentes a la agencia de transportes, quedando nosotros al margen de toda responsabilidad en todo cuanto pueda perjudicar al pronto y perfecto envío de la mercancía.

Tan sólo en envíos superiores a 700€ de importe neto, nos haremos cargo de los gastos ocasionados por su transporte, siempre y cuando se trate de un envío dentro de la península, y en Baleares envíos superiores a 1.000€ de importe neto, siendo a cargo del cliente la totalidad de los gastos de transporte en los envíos que no alcancen la cantidad antes indicada.

En caso de envíos a portes pagados por Manufacturas Plásticas May S.A. se aceptarán reclamaciones por rotura en un plazo máximo de las 24 horas siguientes a la recepción de la mercancía, acompañando fotocopia del albarán de la Agencia de Transporte en el que constará la incidencia de rotura, mal estado, etc...

Los precios que figuran bajo la nomenclatura "230V" se consideran de aparatos con instalación eléctrica compuesta por las correspondientes reactancias, portalámparas, portacebadores, cebadores y cableados para su funcionamiento a tal voltaje, los precios que figuran bajo la nomenclatura "H.F." se consideran de aparatos con instalación eléctrica compuesta por balasto electrónico, portalámparas y cableados para su funcionamiento. En estas instalaciones no se incluye tubos fluorescentes o lámparas a no ser que se encuentre particularmente especificado.

Pasados 6 días de la recepción de una mercancía, el cliente no podrá realizar ninguna clase de reclamación ni devolución de las mismas.

No se aceptan devoluciones de material, salvo previo acuerdo y autorización por nuestra parte, efectuadas por escrito. Los aparatos devueltos sólo se abonarán, como máximo, con el 80% de su valor en factura. Los portes de la devolución correrán por parte del cliente. Los materiales con más de dos años, bajo ningún aspecto serán objeto de ningún abono.

Si por causas ajenas a nuestra voluntad, tales como interrupciones de trabajo, o causas de fuerza mayor, el suministro de nuestros fabricados tuviese un retraso, el comprador no podrá anular su pedido ni cargar penalizaciones por el citado retardo, ya que los plazos de entrega se señalan teniendo en cuenta un curso y ritmo normal de fabricación.

Las dimensiones y características reseñadas, tanto en nuestro catálogo general como en nuestra tarifa de precios, se estima de orientación, sin responsabilidad por nuestra parte en las mismas, Manufacturas Plásticas May S.A. no se hace responsable de posibles errores tipográficos.

Los pagos serán en nuestro domicilio, sin que varíen estas condiciones sean cuales fueren las facilidades de pago que puedan darse al comprador.

En caso de litigio, el cliente se atenderá tan sólo a los tribunales de Bilbao.

Manufacturas Plásticas May S.A. – LUX-MAY – se reserva todos los derechos de modificación o anulación de los productos y precios que aparecen en este catálogo.

ESTA TARIFA ENTRARA EN VIGOR A PARTIR DEL 1 DE FEBRERO DE 2013.

Lux-May

lighting

lighting@lux-may.com • www.lux-may.com